



TRAFFIC OPERATIONS MANUAL

NDDOT PROGRAMMING DIVISION
TRAFFIC OPERATIONS SECTION
JANUARY 2023

Table of Contents

[TRAFFIC OPERATIONS OVERVIEW 4](#)

TRAFFIC OPERATIONS STUDIES

[RURAL SEGMENTS \(2-LANE\) 5](#)

[RURAL SEGMENTS \(4-LANE\) 6](#)

[RURAL HORIZONTAL CURVES 7](#)

[RURAL INTERSECTIONS 8](#)

[URBAN INTERSECTIONS 9](#)

[GRAPHICS FOR TRAFFIC OPERATIONS STUDIES 10](#)

[OTHER TYPES OF TRAFFIC STUDIES 11](#)

[TRAFFIC IMPACT STUDIES FOR NEW DEVELOPMENTS 12](#)

GENERAL SAFETY AND TRAFFIC ANALYSIS

[SPEED LIMIT GUIDELINES 13](#)

[CAPACITY ANALYSIS 15](#)

[INTERSECTION TYPE – HIGH LEVEL 16](#)

[WARNING ENHANCEMENTS FOR RURAL INTERSECTIONS 17](#)

[INTERSECTION CONFLICT WARNING SYSTEMS \(ICWS\) 18](#)

[INNOVATIVE INTERSECTIONS 19](#)

[HORIZONTAL CURVES 20](#)

[CRASH ANALYSIS 21](#)

[LIGHTING WARRANTS 22](#)

[OVERHEAD FLASHING BEACON 27](#)

[PEDESTRIAN CROSSWALK ANALYSIS 28](#)

[PEDESTRIAN CROSSWALK TREATMENTS 29](#)

[LED STOP SIGNS 30](#)

ROADWAY GEOMETRY

[TURN LANES 31](#)

[LEFT TURN LANE 33](#)

[RIGHT TURN LANE 34](#)

[TURN LANE LENGTH 35](#)

[ACCELERATION LANES 36](#)

TRAFFIC SIGNALS

[TRAFFIC SIGNAL WARRANTS 37](#)

[TRAFFIC SIGNAL ANALYSIS 38](#)

[COORDINATED TRAFFIC SIGNALS 39](#)

[TRAFFIC SIGNALS – COMMON TIMING SETTINGS 41](#)

[LEFT TURN PHASING 43](#)

[TYPICAL TRAFFIC SIGNAL DETECTION ZONE LAYOUT 44](#)

[TRAFFIC SIGNAL ADVANCE WARNING BEACONS 45](#)

[REMOVAL OF TRAFFIC SIGNAL 46](#)

ACCESS MANAGEMENT

[ACCESS MANAGEMENT 47](#)

[ACCESS MANAGEMENT NEAR INTERCHANGES 48](#)

[ROADWAY HIERARCHY, NETWORKS, AND TRAFFIC SIGNAL SPACING 49](#)

[TWLTL AND RAISED CENTER MEDIANS 51](#)

[FUNCTIONAL AREA, FRONTAGE ROADS, AND DRIVEWAYS 52](#)

List of Acronyms and Short Names

AADT	Average Annual Daily Traffic
AWSC	All-way stop control (intersection)
DSDS	Dynamic Speed Display Sign
EPDO	Equivalent Property Damage Only
FHWA	Federal Highway Administration
FYA	Flashing Yellow Arrow
HSIP	Highway Safety Improvement Program
HSM	Highway Safety Manual
ICWS	Intersection Conflict Warning System
ITS	Intelligent Transportation Systems
LPA	Local Public Agency
LPI	Leading Pedestrian Interval
LRSP	Local Road Safety Program
MUTCD	Manual on Uniform Traffic Control Devices (2009 Edition)
NDDOT	North Dakota Department of Transportation
NHS	National Highway System
PCE	Passenger Car Equivalent
RCI	Reduced Conflict Intersection
REF95	NDDOT internal database to catalog traffic operations requests
SDOT	State Department of Transportation (acronym used by FHWA)
SHSP	Strategic Highway Safety Plan
SRSP	State Road Safety Program
TAADT	Truck Average Annual Daily Traffic
TOD	Time-of-Day (signal TOD plans)
TRB	Transportation Research Board
TWLTL	Two-way Left Turn Lane
TWSC	Two-way stop controlled (intersection)

TRAFFIC OPERATIONS OVERVIEW

This manual describes typical NDDOT practice for traffic operations work. It is meant to be used as a guideline only and not be a substitute for engineering judgment. This manual is not meant to replace or conflict with commonly accepted references such as the MUTCD, Green Book, Highway Capacity Manual, Highway Safety Manual, Access Management Manual, etc.

NDDOT has adopted the [2009 Manual on Uniform Traffic Control Devices](#). A traffic control analysis should determine whether traffic control devices are needed along the project corridor and should ensure existing devices meet current MUTCD and NDDOT standards. Traffic control devices include signs, markings, traffic signals, and flashing beacons.

In 2018 the NDDOT adopted the [North Dakota Vision Zero Plan](#) (Strategic Highway Safety Plan [SHSP] Update, 2018-2023) which serves as the framework to achieve North Dakota's Vision Zero goal. Eliminating fatalities and serious injuries caused by motor vehicle crashes is the mission statement of this document.

In 2019 the NDDOT adopted the [ND Moves: Statewide Active and Public Transportation Plan](#). This plan serves as a guide for multiple modes of mobility including public transit, walking, and bicycling.

Traffic operations studies provide recommendations for traffic control, need for turn lanes, lighting, signals, beacons and other safety improvements. A typical traffic study should describe the following items (some items may not apply to all studies):

- Documentation and manual references
- Reference previous studies or other related studies (safety analyses, planning documents, etc.)
- Location (project limits, roadway name, reference points, name of city, etc.). A location map may be helpful to the reader. Often NDDOT will put a location map on the cover of the traffic operations study document.
- Project number/PCN (if applicable)
- Description of the proposed work
- Proposed construction year
- Identify the study intersections
- Length of study area
- Assumptions
- Summary of recommendations
- Appendix materials and support documentation
- Every page should have a 407 stamp

407 Stamp

In 1987, Congress determined that federal record keeping requirements were subjecting state transportation agencies to inappropriate litigation and stifling the open discussion of safety issues. Congress enacted 23 United States Codes (U.S.C.), Section 407, to remedy these problems.

23 USC § 407 Documents
NDDOT Reserves All Objections

Railroad Coordination

Traffic operations studies should evaluate railroad crossings within the project area. If a railroad crossing is outside of the project limits or where a railroad runs parallel to the study segment, the following statement from FHWA¹ applies:

Where a railroad-highway grade crossing is physically located "near" a terminus but outside of the project limits, FHWA recommends that the SDOT evaluate and determine the adequacy of warning devices if one or both of the following conditions exist:

1. *A Grade Crossing Advance Warning Sign for the crossing is located within the project limits in accordance with the Manual on Uniform Traffic Control Devices (MUTCD) Part 8, Section 8B.06; and/or*
2. *An intersection traffic control signal within the project limits is or will be linked to the railroad crossing's flashing light signal and gate.*

The following pages describe in further detail the items needed in the traffic study depending on the element being studied. These checklists can be used to write traffic studies for NDDOT projects. Often, projects are a combination of several of these elements (such as a rural highway segment includes rural intersections and horizontal curves). The checklists, flowcharts and tables were created to encourage a consistent decision-making process.

References:

1. FHWA Memo, "[Railroad Coordination on Federal-Aid Highway Projects](#)", July 31, 2015.

RURAL SEGMENTS (2-LANE)

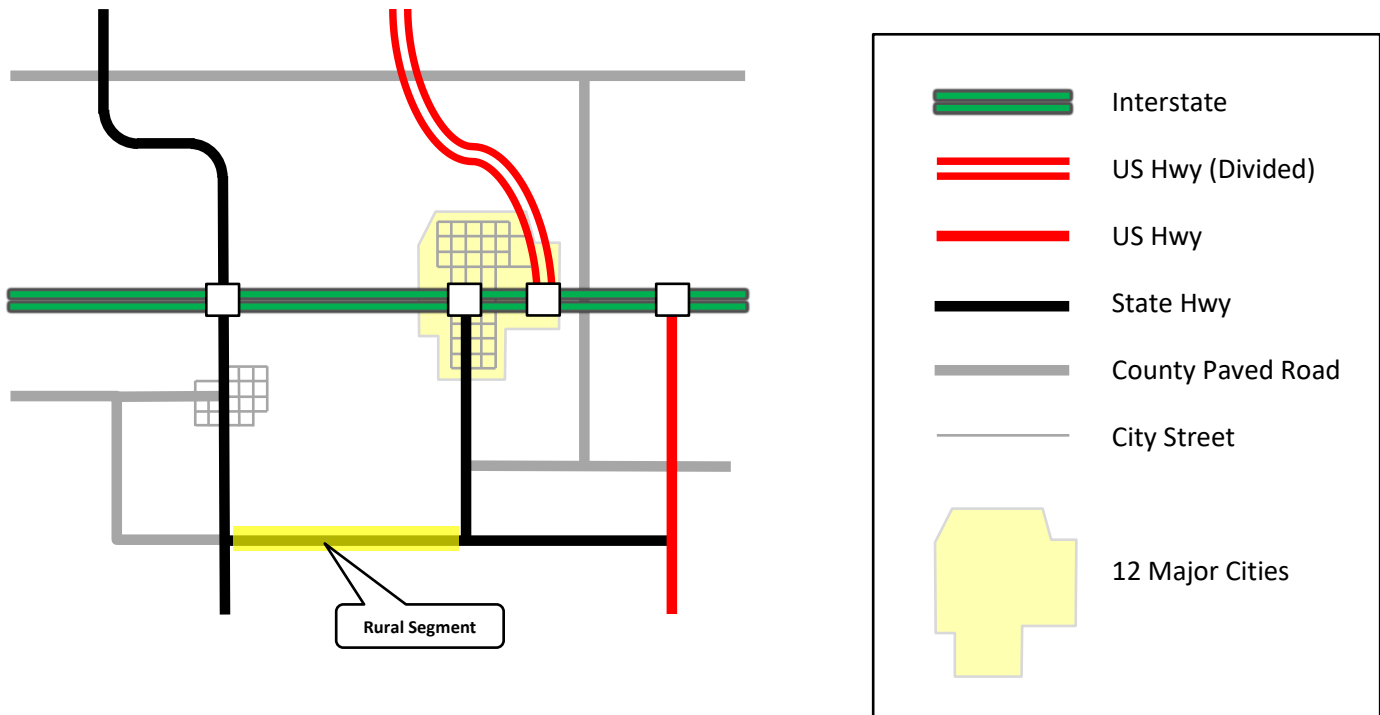

A traffic study of a rural segment on a 2-lane highway typically contains the following:

- Traffic data – average annual daily traffic (AADT), truck average annual daily traffic (TAADT) – describe how and when it was collected, also indicate the projected 20-year forecasted traffic volumes
- Roadway speed limit(s) – describe any speed zones, provide beginning and ending reference points (on state system)
- Roadway geometry (number of lanes, presence of passing lanes, typical section, lane widths, shoulder widths, etc.)
- Highway performance classification
- Functional classification
- Describe horizontal/vertical alignment
- Presence of railroad crossings – identify the use of rail lines as freight and/or passenger. If known, supply the number of crossings that occur daily at that location
- Surrounding land use
- Capacity analysis – see chapter 15 of the HCM¹ for two-lane highways analysis
- Crash history and analysis
- [Lighting warrants](#)
- Cross reference HSIP – check SRSP or LRSP documents for recommended safety improvements of rural roadway segments based on risk assessments
- Existing or planned pedestrian accommodations, bike routes, bus stops
- Summary of recommendations

References:

1. TRB, “Highway Capacity Manual, Sixth Edition,” October 2016.

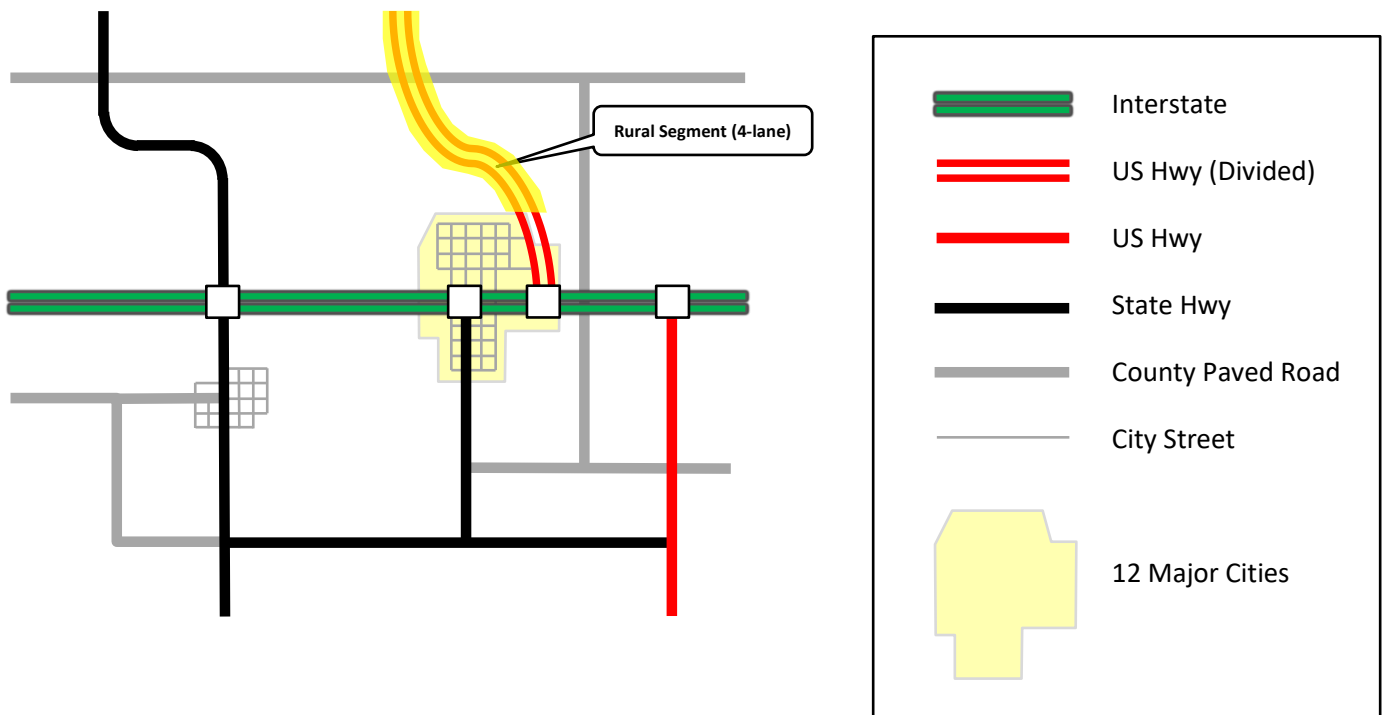
RURAL SEGMENTS (4-LANE)

A traffic study of a rural segment on a multi-lane highway typically contains the following:

- Traffic data – average annual daily traffic (AADT), truck average annual daily traffic (TAADT) – describe how and when it was collected, also indicate the projected 20-year forecasted traffic volumes
- Roadway speed limit(s) – describe any speed zones, provide beginning and ending reference points (on state system)
- Roadway geometry (number of lanes, typical section, lane widths, shoulder widths, etc.)
- Highway performance classification
- Functional classification
- Describe horizontal/vertical alignment
- Presence of railroad crossings
- Surrounding land use
- Capacity analysis – see chapter 12 of the HCM¹ for multi-lane highways analysis
- Crash history and analysis
- [Lighting warrants](#)
- Cross reference HSIP – check SRSP or LRSP documents for recommended safety improvements of rural roadway segments based on risk assessments
- Existing or planned pedestrian accommodations, bike routes, bus stops
- Summary of recommendations

References:

1. TRB, "Highway Capacity Manual, Sixth Edition," October 2016.

RURAL HORIZONTAL CURVES

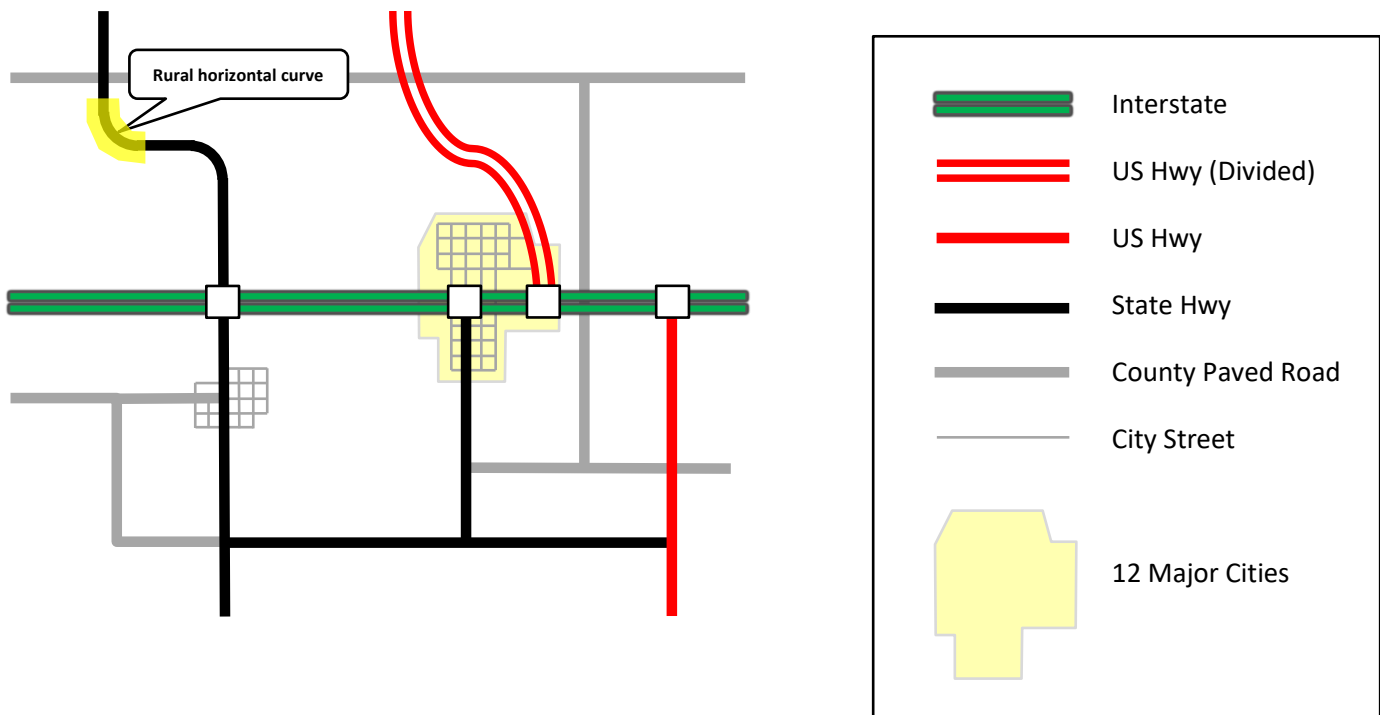

Curves are often a subset analysis of a larger traffic study for a roadway segment. Items specific to the analysis of horizontal curves in a traffic study:

- ❑ Curve radius and evaluation of signing based on the design manual¹
- ❑ Presence of intersection(s) along the curve
- ❑ Presence of a “visual trap” (where the line of sight makes the roadway appear to continue straight but the main highway actually has a curve)
- ❑ Cross reference HSIP – check SRSP or LRSP documents for recommended safety improvements of rural horizontal curves based on risk assessments

Radial-T

A radial-T intersection project involves the removal of skewed intersection(s) on a curve. The curve is on the major roadway and the reconstruction project brings the minor road into the curve at a 90° angle.



Although this type of configuration is common in North Dakota, the traffic operations study should look at each location on a case-by-case basis. All options should be analyzed when looking at a location for a potential radial-T project.

References:

1. NDDOT, “[Design Manual](#)”. August 2013. (Section III-09.04)

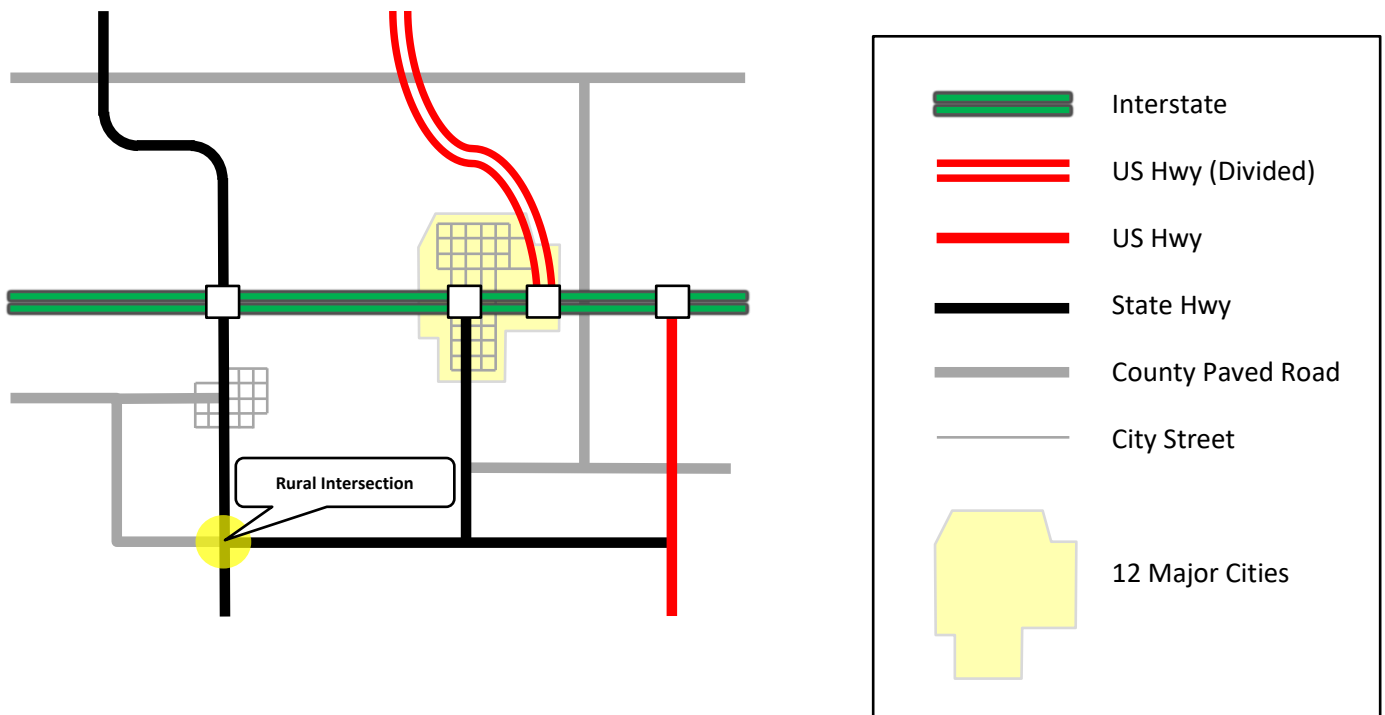
RURAL INTERSECTIONS

Rural intersections may be a subset of a larger traffic study for a roadway segment or are sometimes their own study. Intersections that should be studied are state highways, CMC routes, or paved county roads. Items specific to the analysis of rural intersections in a traffic study:

- AADT and TAADT on all approaches. A “turning movement diagram” that shows the daily volumes of through and turning movements is necessary
- Existing type of intersection control (TWSC, AWSC, Signal, Roundabout, etc.)
- Intersection capacity analysis – see chapter 20 of the HCM¹ for TWSC, chapter 21 for AWSC, chapter 22 for roundabouts, chapter 19 for signals
- Intersection related crash history and analysis
- Turn lanes (need to add left or right turn lanes, determine length of turn lanes)
- Recovery Approaches (or need for them)
- Signal Warrants (only for high volume locations)
- [Lighting warrants](#)
- Intersections with existing overhead mounted flashing beacons should be recommended for removal (see page 28)
- Cross reference HSIP – check SRSP or LRSP documents for recommended safety improvements of rural intersections based on risk assessments
- Alternative options for the configuration of the intersection (such as a radial-T – see previous page)
- Existing or planned pedestrian accommodations, bike routes, bus stops
- Summary of recommendations

NDDOT has adopted a policy² on the installation of Do Not Enter and Wrong Way signs at stop controlled divided highway intersections.

References:

1. TRB, “*Highway Capacity Manual, Sixth Edition*,” October 2016.
2. NDDOT, “[Installation of Do Not Enter and Wrong Way signs at Stop Controlled Divided Highway Intersections](#)”, July 2011.

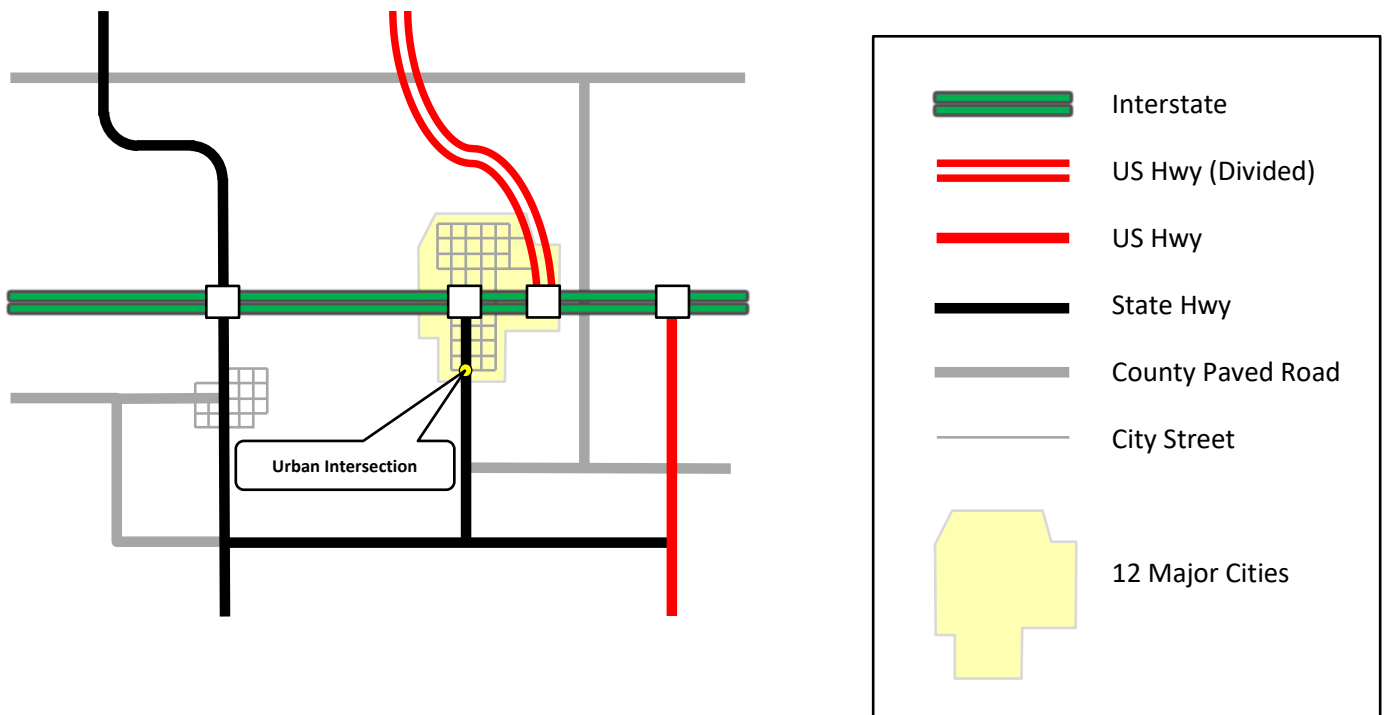
URBAN INTERSECTIONS

Items specific to the analysis of urban intersections in a traffic study:

- Existing type of intersection control (TWSC, AWSC, Signal, Roundabout, etc.)
- AADT and TAADT on all approaches. A “turning movement diagram” that shows the daily volumes of through and turning movements is necessary
- For signal warrant evaluation, a turning movement count at the intersection for a minimum of 12 hours is required. Typically, NDDOT collects a 24-hour turning movement count.
- Intersection capacity analysis – see chapter 19 of the HCM¹ for TWSC, chapter 20 for AWSC, chapter 21 for roundabouts, chapter 18 for signals
- Intersection related crash history and analysis
- Turn lanes (need to add left or right turn lanes, determine length of turn lanes)
- Signal Warrants (where necessary)
- [Lighting warrants](#)
- Cross reference HSIP – check LRSP document for recommended safety improvements of urban intersections based on risk assessments
- Existing or planned pedestrian accommodations and/or bike routes
- Note any public transit infrastructure including bus stops, public transit signal infrastructure and transit specific pedestrian accommodations at or near urban study intersections.
- Identify any public transit operational needs (such as queue jump or public transit signal priority)
- Summary of recommendations

References:

1. TRB, “Highway Capacity Manual, Sixth Edition,” October 2016.

GRAPHICS FOR TRAFFIC OPERATIONS STUDIES

Traffic operations studies should include tables, drawings, maps, aerial photos or other graphics to help communicate the issues and analysis. The location map of the project is generally included early in the report, possibly on the title page as shown below.

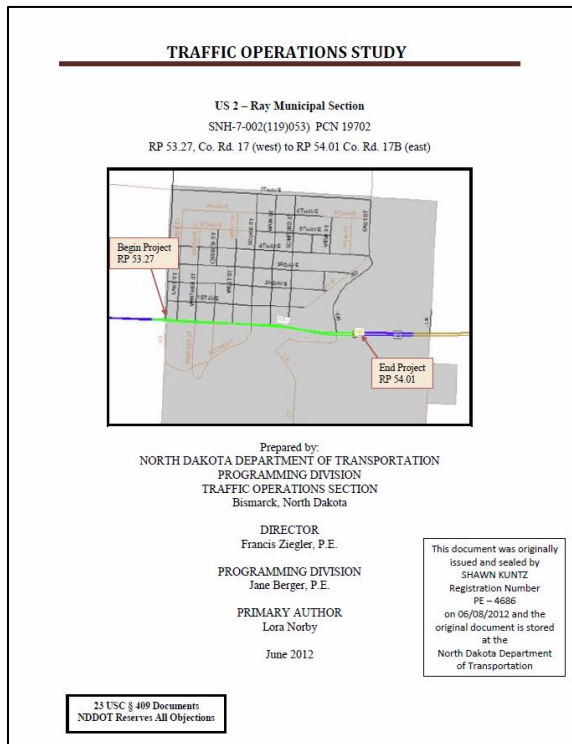

Where the traffic study recommends changes to intersection geometry, a helpful graphic is an intersection “schematic” showing the layout of turn lanes with proposed lengths. This type of graphic is a helpful tool to reference during the design phase of a project. Shown below are some samples.

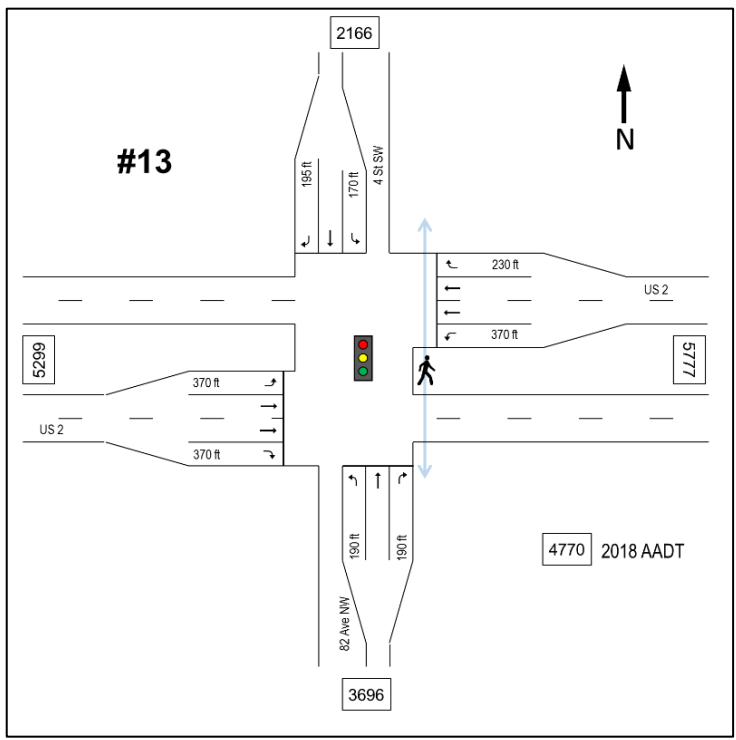
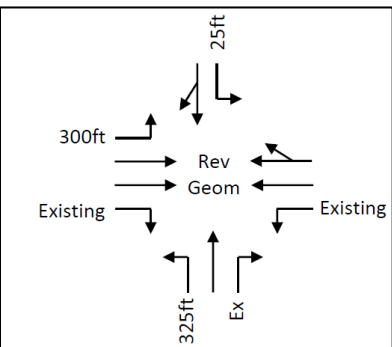
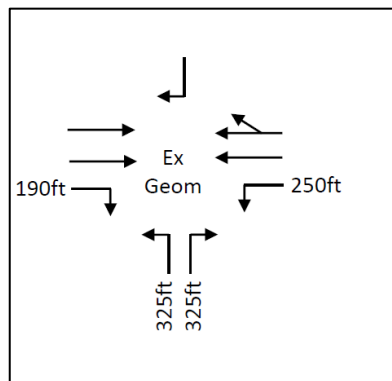

OTHER TYPES OF TRAFFIC STUDIES

Temporary Traffic Control

A “work zone safety and mobility¹” analysis should be done for significant projects. A project is considered “significant” where it exceeds an estimated \$3,000,000 in cost and is on the urban regional system that either goes through a Metropolitan Planning Organization (MPO) boundary or city over 25,000 in population. Traffic operations will analyze the existing level of service of the facility and compare that with the level of service under work zone traffic control. The traffic control plan is acceptable if the level of service is no less than two grades lower than the existing and traffic delays are less than 15 minutes. Describe the need for contractors and other personnel to maintain space for people walking and biking in construction zones.

Highway Safety Improvement Program

Infrastructure-related highway safety improvements are developed through the Highway Safety Improvement Program (HSIP). The program’s goal is to reduce fatalities and serious injuries. Applications for HSIP projects come from NDDOT districts, MPO’s, cities, counties and tribal governments. Potential HSIP projects may require special traffic studies to evaluate the proposed safety improvements. Projects can be created to address crash problems on a particular roadway or at intersections (reactive). Projects may also be developed on a “systemic” basis where a roadway or intersection has a high number of risk elements (proactive).

References:

1. NDDOT, [“Work zone Safety & Mobility”](#), February 2007.

TRAFFIC IMPACT STUDIES FOR NEW DEVELOPMENTS

To obtain NDDOT support for proposed developments having either direct or indirect access to the ND State Highway System, developers should submit the expected number of trips per day to the [NDDOT District Engineer](#) (in writing). This submission should include a short discussion on how this number was estimated (usually based on expected number of employees, customers and/or deliveries, residents etc). If the new traffic generated by the development is proposed to use an existing access point, the current access point volume and build volumes should be submitted. The District Engineer may choose to pass on this information to the Central office for additional support/direction/review. If the District Engineer decides that a traffic engineering analysis is necessary, the developer is responsible for providing a study completed by a professional engineer registered in the state of North Dakota. This decision is typically based on the anticipated number of trips generated by a development. A “study intersection” is defined as an existing or proposed intersection that will introduce new turning traffic—resulting from the development. A trip is defined as a one-direction vehicle movement with either the origin or the destination (exiting or entering) inside the site. Over time, changes in land use within property may create additional trips which may necessitate revisions to the accesses—NDDOT reserves the right to request the developer provide further information about proposed modifications to their property.

Less than 100 trips per day and less than 30% trucks

A traffic engineering study is typically not necessary (except where the district engineer requests one based on issues such as terrain, sight distance or other engineering judgment), turn lanes or other traffic control modifications are typically not necessary. The developer should provide in writing:

- Size of property in acres and a description of how the property will be used
- The number of proposed buildings with square footages
- Number of employees/residents expected when the property is fully developed
- The expected number of trips per day (including number of truck trips, new pedestrian/bicycle trips)
- What hour of the day will generate the highest number of trips and how many trips are expected during that time period.

100 to 1,000 trips per day or truck percentage greater than 30%

A written traffic engineering study should include the items above and also provide the following:

- Verify the expected number of trips per day generated by the development (“Trip Generation” Manual from ITE)
- Discussion and/or diagrams showing site circulation (site plan)
- Sight distance evaluation at study intersections
- Study intersection design
 - Include a recommendation on the need for right and/or left turn lanes.
 - If turn lanes are recommended, the study should use NDDOT design practices to indicate the length of the proposed turn lanes including tapers, etc.

1,000 to 5,000 trips per day

In addition to items listed above, the written traffic study should provide:

- Capacity analysis at study intersections
- Crash data analysis at existing study intersections (NDDOT will provide the crash data per the developer’s request)
- Trip distribution (evaluate number, location, and spacing of access points). Provide expected directional distribution of trips (for example, 30% from the west, 70% from the east) and indicate if the truck directional distribution varies from the vehicle directional distribution.

Greater than 5,000 trips per day

In addition to items listed above, the written traffic study should provide:

- Background traffic growth and evaluation of future traffic
- Traffic signal warrant analysis – with a recommendation for signalization, roundabout or other traffic control devices
- Lighting analysis at study intersections
- Evaluate adjacent intersections that may be impacted by the development (capacity analysis, crash history, etc). The study shall take into consideration any applicable transportation plans in the area.

SPEED LIMIT GUIDELINES

These guidelines outline when to change posted speed limits and what speed to set as the posted speed. These guidelines do not apply to major cities; major cities should be handled on a case-by-case basis. These guidelines also do not apply to construction zones, school zones, temporary special events (such as fairs), weather events (such as flooding), or warning sign advisory speeds (such as for curves or bumps).

A “speed zone” is a speed limit that is less than the statutory maximum speed limit set by law. North Dakota’s current statutory maximum speed limits are:

- 75 mph for Interstates,
- 70 mph for multi-lane divided highways,
- 65 mph for paved two-lane highways
- 55 mph for paved two-lane county or township highways or gravel roads.



In accordance with the federal Manual on Uniform Traffic Control Devices (MUTCD) and state law, an engineering study shall be the basis for installing or revising speed zones. The MUTCD also adds that “The engineering study shall include an analysis of the current speed distribution of free-flowing vehicles.”

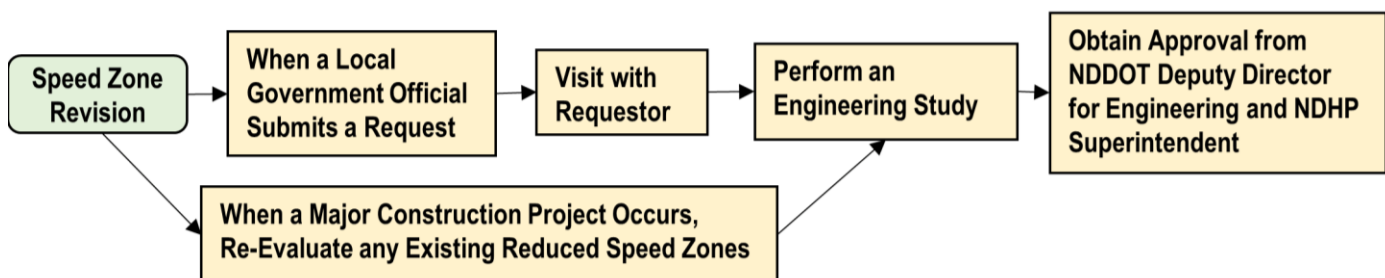

The primary purpose of the speed limit is to advise drivers of the maximum reasonable and safe operating speed under favorable conditions. Speed limits should be accepted as reasonable by most drivers. Not all drivers will conform to reasonable speed limits. In essence, speed limits separate high-risk and reasonable behavior.

Selecting an appropriate speed limit can be a polarizing issue for a community. Residents and vulnerable road users generally seek lower speeds to promote quality of life for the community and increased security for pedestrians and cyclists; motorists seek higher speeds that minimize travel time. Despite the controversy surrounding maximum speed limits, it is clear that the overall goal of setting the speed limit is to increase safety within the context of retaining reasonable mobility.

SPEED LIMIT GUIDELINES (CONTINUED)

The 85th percentile speed is the speed 85% of free-flowing vehicles are traveling at or below. The use of the 85th percentile speed as the primary criterion for selecting a suitable speed limit is founded on the following fundamental concepts deeply rooted in government and law:

- Driver behavior is an extension of social attitude, and the majority of drivers respond in a safe and reasonable manner as demonstrated by their consistently favorable driving records.
- The normally careful and competent actions of a reasonable person should be considered legal.
- Laws are established for the protection of the public and the regulation of unreasonable behavior on the part of individuals.
- Laws cannot be effectively enforced without the consent and voluntary compliance of the public majority.

The posted speed limit shall not exceed the statutory maximum speed limit set by state law. The posted speed limit should be within 5 mph of the 85th percentile speed of free-flowing traffic. If the posted speed is set lower than the 85th percentile speed, it shall not be set less than the 50th percentile speed. The maximum posted speed when approaching a traffic signal should be \leq 55mph, based on NDDOT's standard practice. The posted speed should not be established based on an isolated restrictive feature (e.g. sharp curve) within a segment. The use of an advisory speed should be considered at these locations.

Setting speed limits lower than the 85th percentile speed can have several negative effects, including:

- Need for increased enforcement to ensure driver compliance.
- Potential for increased crashes due to larger variability in vehicle speeds.
- Mistrust of highway and enforcement officials and potential disregard for other speed limits, because motorists do not readily perceive the need for lower speeds.

Research has repeatedly shown that changes in posted speeds have little effect on operating speeds. Many drivers will continue driving the speed they are comfortable with, regardless of the posted speed.

Except for construction zones, speed limits shall not be reduced by more than 20mph at one time. When a speed limit is reduced by more than 10mph, a reduced speed limit ahead (W3-5) sign should be used. When there are multiple successive speed reductions, refer to [NDDOT's Design Manual](#) (Table III-09.09) for the required minimum spacing between speed limit signs.

Some possible countermeasures to reduce speeding are:

- Increase the presence/visibility of law enforcement.
- Install dynamic speed display signs in accordance with NDDOT's Guidelines for the Use of Dynamic Speed Display Signs.
- Implement traffic calming.
- Perform a speed study and raise the posted speed limit if appropriate.

Guidance on speed zone engineering studies (Excel Spreadsheet):

<https://www.dot.nd.gov/divisions/programming/docs/SpeedZoneEngineeringStudy.xlsx>

CAPACITY ANALYSIS

Capacity analysis should follow the procedures of the Highway Capacity Manual¹. The author should note any software program used during the capacity analysis. NDDOT uses HCS and/or Synchro-Simtraffic. However, NDDOT does not adopt or recommend any specific software for capacity analysis.

For study intersections with turning movement data, NDDOT uses the four highest consecutive 15-minute periods as the peak hour. Typically this is the PM peak hour. In urban areas, additional time-periods may need analyses especially where there is a large inbound traffic in the morning (AM peak) as compared to outbound in the evening.

Typical items from the capacity analysis:

- Determine the number of traffic lanes needed, including the need for any turning lanes (see turn lane section) or passing lanes.
- Recommend the type of intersection geometry/traffic control (two-way stop, all-way stop, signal, roundabout, RCI, etc.)
- Establish signal phasing, timing, and coordination needs (if applicable, see traffic signals section)
- Identify operational problems (provide guidance to relocate or close driveways near intersections, consolidate driveways or other access points, etc.)
- Establish the “level of service” (LOS) for each intersection to be studied and when appropriate, the entire arterial or roadway segment. Include pedestrian and bicycle level of service in the capacity analysis.

NDDOT Guidance on LOS

The capacity analysis is one factor to determine the recommended geometric design. The NDDOT *guidance* is to meet or exceed an overall **LOS D** under 20-year projected automobile traffic.

Further guidance on LOS can be found from Table 2-5 of the Green Book. However, “The recommended values in the Green Book are regarded by FHWA as guidance only.”³

Normally the report discusses the study intersections’ operation with the proposed lane geometry under the 20-year projected volumes. Some studies may require analysis of both existing and proposed lane geometry. If an intersection does not currently meet signal warrants, but is likely to with the future volumes, a signalized capacity analysis (on proposed geometry) of the 20-year projected volumes should be included in the study. This does not mean a signal has to be a recommendation in the study, but this will inform the reader that the proposed geometry (turn lanes) will be adequate for future conditions. If a two-way stop control intersection is calculated at LOS F for the minor street approaches, and the likelihood of meeting signal warrants within 20 years is low, it is not necessary to determine the necessary geometry to meet NDDOT LOS guidance.

Projected traffic volumes are based on a yearly growth factor that may be obtained from the NDDOT Roadway Data Section. In urban MPO areas, traffic volumes may be obtained from citywide traffic models.

For rural areas, a 20-year volume projection can be used for capacity analysis. Note that two-way stop controlled rural expressway intersections tend to experience safety issues long before they experience congestion².

References:

1. TRB, “*Highway Capacity Manual, Sixth Edition*,” October 2016.
2. TRB, “[NCHRP Report 650: Median Intersection Design for Rural High-Speed Divided Highways](#)”, 2010. (page 149)
3. FHWA Memo, “[Level of Service on the National Highway System](#)”, May 6, 2016.

INTERSECTION TYPE - HIGH LEVEL

Given the AADT's on the major and minor roads, use the chart below as a *starting point* to determine the appropriate type of analysis of a study intersection. The acronyms are explained in further detail below.

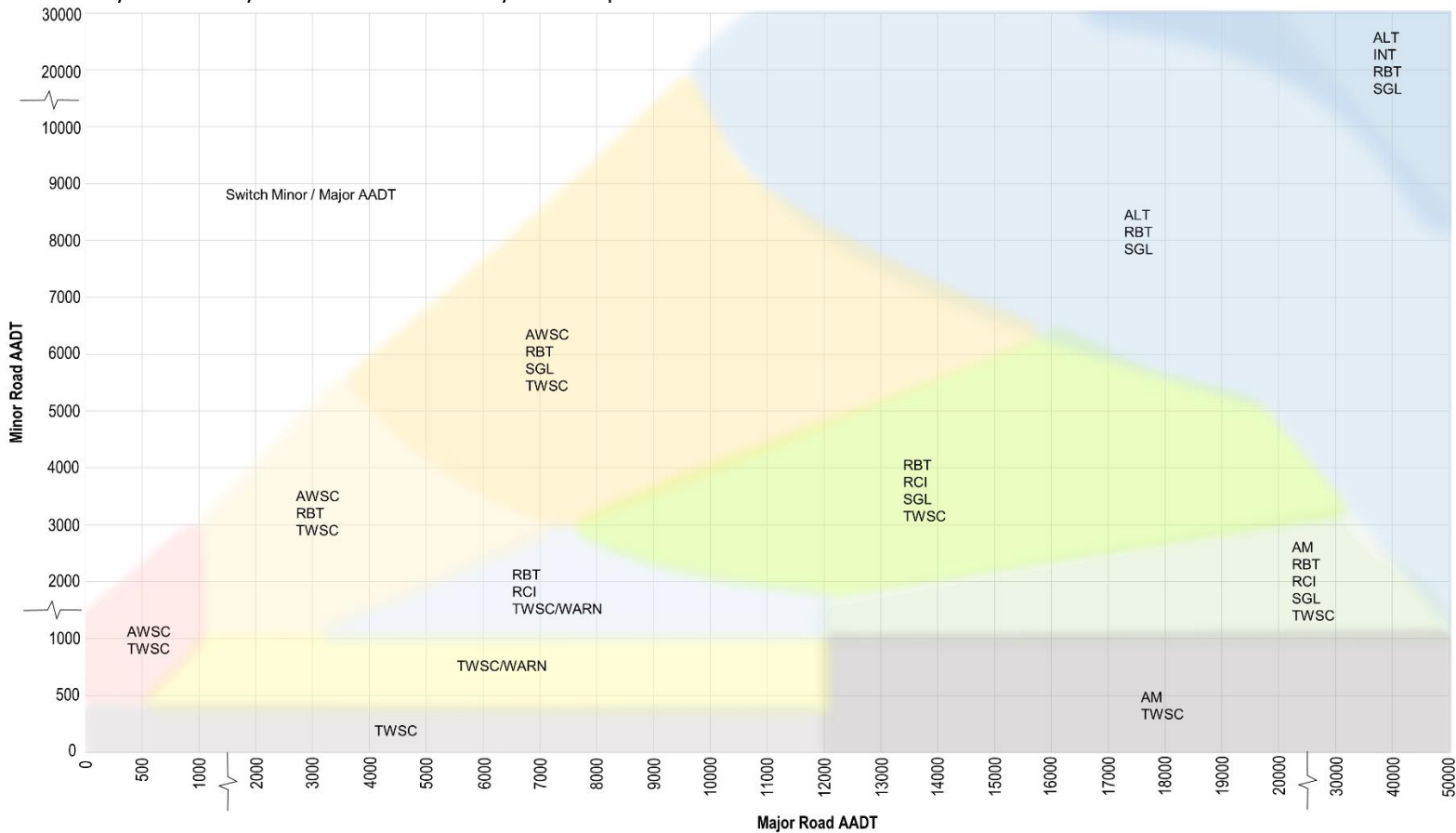

- ALT:** Alternative Intersections – As traffic volumes increase, conventional intersections may no longer be appropriate. A displaced left turn is an example of an alternative intersection. For more information see FHWA: https://safety.fhwa.dot.gov/intersection/alter_design/
- AM:** Access Management - Removing a minor road connection can be considered in cases where the minor road has a very low volume and the major road has heavy traffic. Opportunities to reroute the minor road traffic to a different location should be explored. Other options for access management may be ¾ intersection or right-in/right-out. See [Access Management](#) section.
- AWSC:** All-way Stop Control - Stop control is in place on all intersection approaches. This type of intersection works best without the presence of turn lanes where a 2-lane road meets with another 2-lane road. Use [SFN form 59012](#) to evaluate MUTCD warrants for all-way stop control.
- INT:** Interchange – A grade-separated intersection
- RBT:** Roundabout – This type of intersection is becoming more common throughout the country due to their proven safety benefits. They may be considered at any intersection. A rule of thumb for a traffic study is to consider a roundabout when both the major road and minor road AADT is over 1000.
- RCI:** Reduced Conflict Intersection - this type of intersection reduces the number of conflict points by re-routing left turn movements from the minor road.
- SGL:** [Traffic Signal](#) - an analysis of MUTCD warrants should be done prior to a traffic signal capacity analysis.
- TWSC:** Two-way Stop Control - The most common type of intersection where the major road is free-flow and the minor road traffic is controlled by a stop sign.
- WARN:** [Warning Enhancements for rural intersections](#) – adding additional emphasis to an existing TWSC intersection using signing and markings may be appropriate.

WARNING ENHANCEMENTS FOR RURAL INTERSECTIONS

Additional enhancements may be considered for two-way stop control intersections in rural areas (where major road speeds are over 40 mph). To make drivers more aware of the intersection, the following items may be considered:

- Stop-ahead sign (W3-1)
- Larger stop sign (36" x 36" or larger) with higher retroreflective sheeting
- Retro-reflective strip on sign supports
- No-passing zone on major road (to prevent overtaking crashes)
- "STOP AHEAD" pavement markings & stop bar
- Intersection transverse rumble strips (where noise is not a concern)
- Intersection lighting (evaluate [warrants](#))
- Double arrow sign (for T-intersections only)
- Second STOP sign on left side of the minor road
- Second Stop-ahead (W3-1) on left side of minor road
- Intersection warning sign on the major road (such as W2-1, W2-2)
- Second intersection warning sign on left side of major road
- [LED Stop sign](#)
- Speed reduction on major road
- [Intersection Conflict Warning System](#)
- Traffic Operations study (consider roundabout, RCI, etc)

The items are generally listed in order of preference of application—items toward the top should be tried first if possible before moving on to more substantial warning enhancements such as ICWS. Note that most right-angle crashes at rural TWSC intersections are associated with gap recognition as opposed to intersection recognition. These enhanced conspicuity countermeasures will not help motorists select better gaps.

A sample "package" of warning enhancements for a generic intersection is shown below.

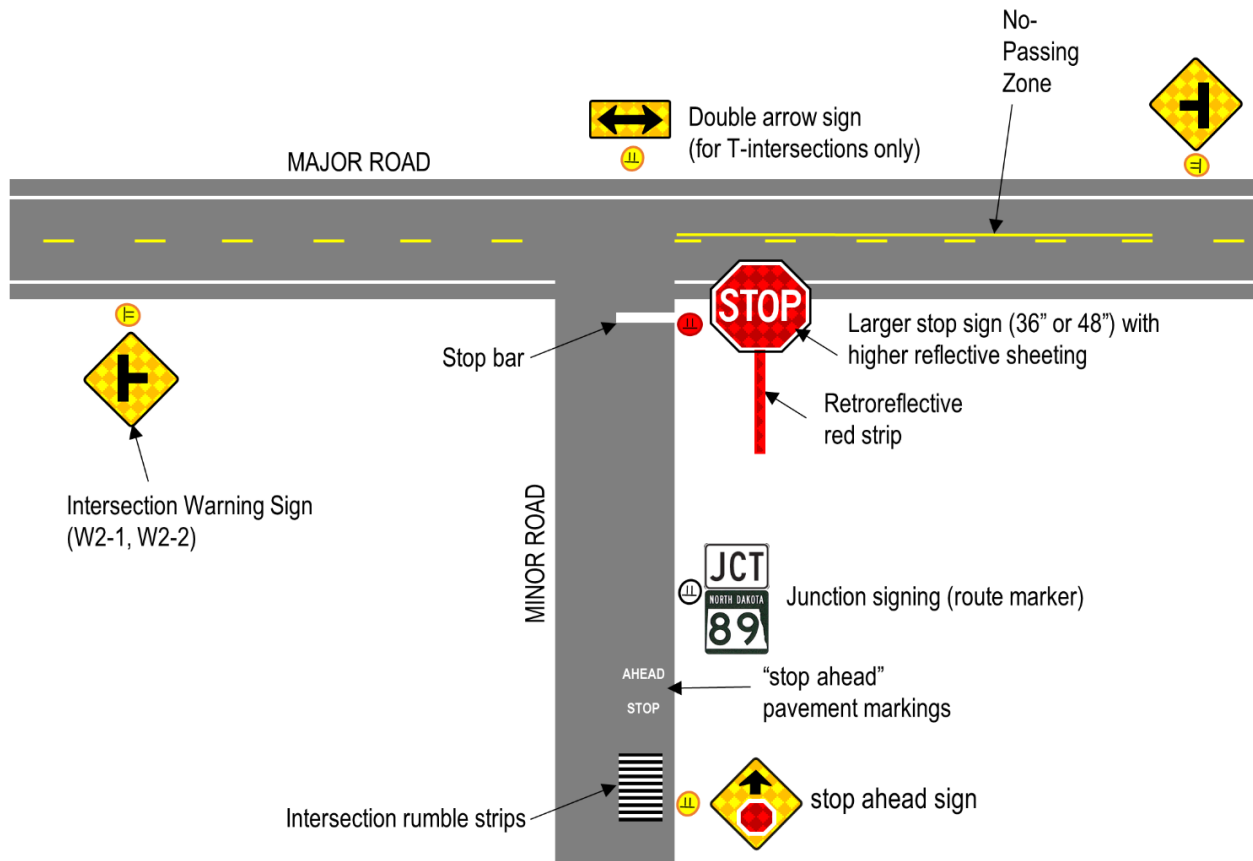

INTERSECTION CONFLICT WARNING SYSTEM (ICWS)

Intersection Conflict Warning Systems (ICWS) are traffic control devices to provide drivers with a real-time, dynamic warning of vehicles approaching or waiting to enter the intersection¹. These systems apply to intersections with stop control on the minor approach. Unlike continuously flashing indications, flashing lights that are dynamic are much more effective.

Consider ICWS:

- Major road speed limit is 45 mph or greater¹
- Where there is evidence of drivers on the minor road taking risks by proceeding into the intersection (caused by errors in “gap recognition”).
- Limited sight distance¹
- Intersection skew is greater than 15 degrees¹
- Major AADT is less than 12,000
- Minor AADT is less than 3,000
- A stop-controlled intersection substantially below MUTCD traffic signal warrants
- Ratio of minor AADT to major AADT ≤ 0.5

“Intersections that are at or near one or more of the warrants to consider traffic signals as a potential solution to known safety concerns are not suitable candidates for this system.”²

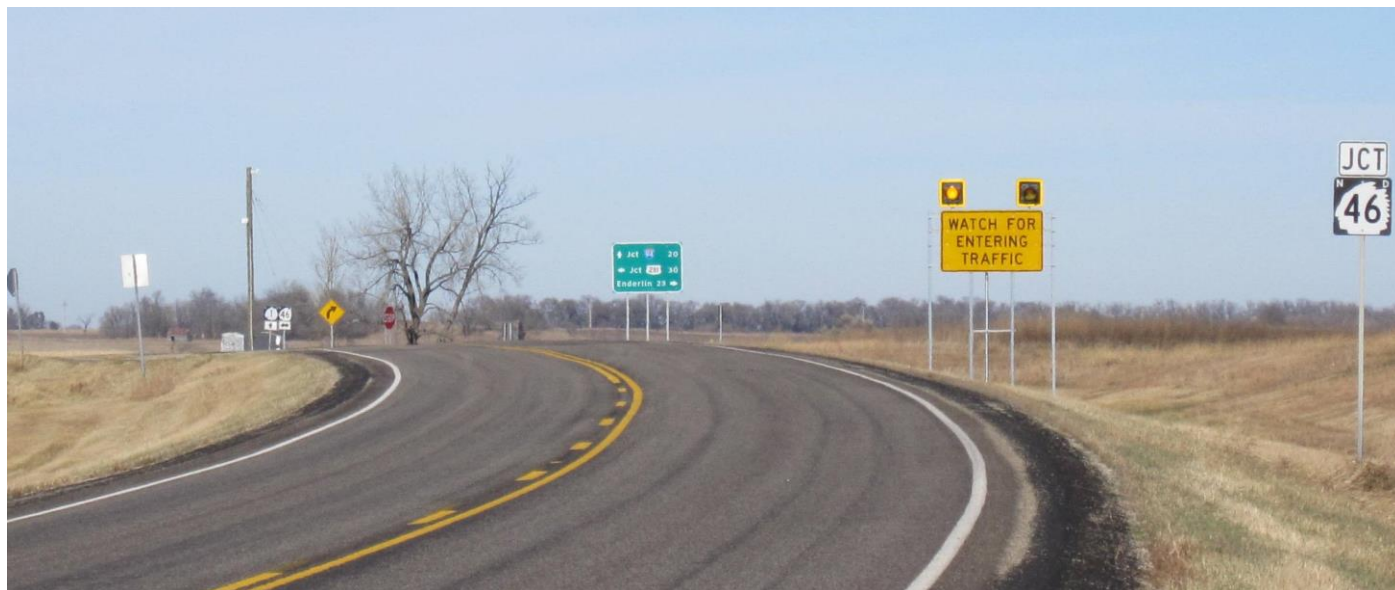

References:

1. <http://enterprise.prog.org/itswarrants/icws.html>
2. FHWA, [Stop-Controlled Intersection Safety: Through Route Activated Warning Systems](#), May 2011.

INNOVATIVE INTERSECTIONS

Reduced Conflict Intersection (RCI)

Right-angle collisions (particularly on the far-side) are the predominant crash type at conventional TWSC rural expressway intersections¹. Vehicles get hit after stopping on the minor road then proceeding into the intersection (obeying the stop sign isn't usually the problem). To make a left turn from the minor street with this countermeasure, a vehicle must turn right at the stop sign, and then make a U-turn. For minor road traffic, it is a small inconvenience, but provides a substantial improvement of safety. Merge, diverge and turning conflicts result in fewer and less severe crashes².

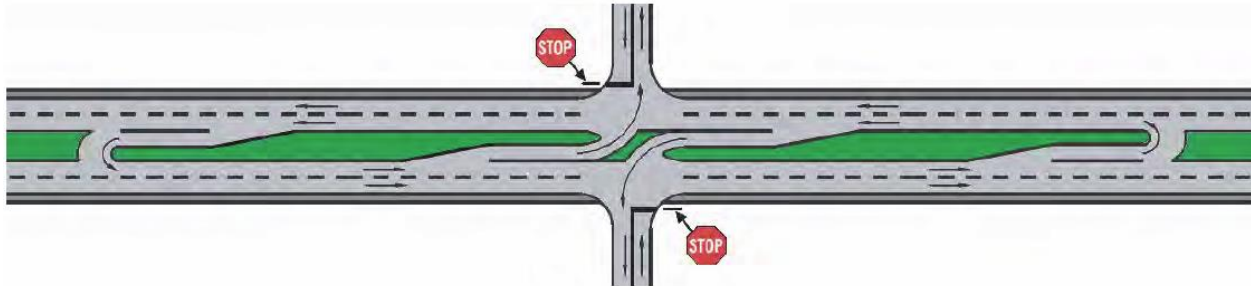

Roundabouts

A roundabout is a proven countermeasure³ and has been shown to reduce the numbers of fatalities and serious injuries when compared to traditional intersections. Roundabouts have been demonstrated to be a particularly effective treatment in reducing fatalities and injuries at intersections on high-speed roadways⁴. Key considerations for roundabouts in North Dakota:

- "[It is] important to use the minimum number of entry, circulating, and exit lanes subject to capacity considerations." (from NCHRP Report 672⁴ section 5.2.2)
- "The number of lanes provided at the roundabout should be the minimum needed...The engineer is discouraged from providing additional lanes that are not needed for capacity purposes as these additional lanes can reduce the safety effectiveness at the intersection." (from NCHRP Report 672⁴ section 6.5.1)

References:

1. Transportation Research Board, NCHRP Report 650: Median Intersection Design for Rural High-Speed Divided Highways, 2010.
2. Minnesota Department of Transportation, Traffic Safety Fundamentals Handbook, August 2008.
3. FHWA, [Promoting the Implementation of Proven Safety Countermeasures](#), January 2012.
4. Transportation Research Board, [NCHRP Report 672: Roundabouts: An Informational Guide](#), 2010.

HORIZONTAL CURVES

Horizontal alignment signs, informally called curve warning signs, can improve safety by alerting drivers to changes in roadway geometry that may not be apparent or expected¹.

Chevron signs (W1-8) are very effective because they provide information to motorists where they need it the most – within the actual horizontal alignment². Because of their pattern and size and that several of the signs are in view of the motorist, they define the direction and sharpness of the curve the best of all the traffic control devices³.

Horizontal alignment sign guidance based on posted speed:



- 45 mph posted speed: Curve signs recommended where radius is less than 725 ft
 Chevrons recommended where radius is less than 550 ft
- 50 mph posted speed: Curve signs recommended where radius is less than 950 ft
 Chevrons recommended where radius is less than 725 ft
- 55 mph posted speed: Curve signs recommended where radius is less than 1200 ft
 Chevrons recommended where radius is less than 950 ft
- 60 mph posted speed: Curve signs recommended where radius is less than 1500 ft
 Chevrons recommended where radius is less than 1200 ft
- 65 mph posted speed: Curve signs recommended where radius is less than 1900 ft
 Chevrons recommended where radius is less than 1500 ft
- 70 mph posted speed: Curve signs recommended where radius is less than 2300 ft
 Chevrons recommended where radius is less than 1900 ft
- 75 mph posted speed: Curve signs recommended where radius is less than 2700 ft
 Chevrons recommended where radius is less than 2300 ft

The MUTCD allows for combination warning signs (W1-10, W1-10b) to show the curve ahead with the presence of an intersecting road:



References:

1. FHWA, [Manual for Selecting Safety Improvements on High Risk Rural Roads](#), August 2014.
2. FHWA, [Roadway Departure Safety](#), January 2011.
3. FHWA, [Low-Cost Treatments for Horizontal Curve Safety](#), 2016.

CRASH ANALYSIS

The evaluation of crash history may help to identify existing problems. The crash analysis section of the study may identify alternatives to help reduce potential crashes. Recommendations such as installing rumble strips, adding or modifying signing/stripping, changing horizontal/vertical alignment are examples of possible countermeasures. Safety improvements must consider all road users (pedestrians, bicycles, etc.).

Traffic operations studies require the collection of crash data. For local governmental agencies and consultants this data will be provided by NDDOT using the email request format shown below:

I am requesting crash data for X Avenue from X Street to X Street and all links in between (see attached map).

I recognize this crash data is considered to be exempted from disclosure pursuant to 23 USC § 409, and can be used only with the understanding that the City of X or its agents will not release or transfer it, nor will it be used for anything other than the intended purpose as a part of a safety study or safety improvement project.

This data will be used by our staff with the City of X, and/or acting as its agent, in the development of a study.

Several crash analysis items that are discussed in a traffic study:

- Beginning and ending dates of crash data gathered (Use 5 years for rural locations and a minimum of 3 years for urban locations)
- Total number of crashes
- Breakdown of the common crash types (how many angle, rear-ends, etc.)
- Note any crashes involving pedestrians and or bicyclists
- Describe crash patterns relating to weather, roadway conditions, light vs. dark, etc.
- Crash summary sheets (usually included as an appendix)
- Possible countermeasures
- Note if the study area is listed on any NDDOT crash listings – rural intersection high crash list or urban intersection high crash list,
- Indicate severity of the segment(s) referenced from the latest state highway segment crash map. This map shows the weighted crashes per mile.
- Highway Safety Manual¹ expected number of crashes (optional)

Crash severity (from HSM¹ page 3-4):

K	Fatal – (one or more persons died within 30 days)
A	Incapacitating Injury
B	Non-incapacitating Injury
C	Possible Injury
O or PDO	No Injury / Property Damage Only

References:

1. AASHTO, "[Highway Safety Manual](#)", 2010.

LIGHTING WARRANTS

An engineering study should be completed using the following warrants. Policy regarding maintenance and operation of the lighting can be found in Executive Policy II 8-1.1 and II 8-1. Lighting design is based on AASHTO guidelines¹. Some terms used when referring to lighting warrants are defined below:

Freeway/Interstate= Arterial highway with full control of access. There are no at-grade intersections.

Urban = City having a population $\geq 5,000$.

Suburban = Within 5 miles of an urban boundary

Rural = 5 miles or more from an urban boundary

1 Continuous Freeway/Interstate Lighting Warrant

Continuous Freeway/Interstate Lighting provides relatively uniform lighting on all main freeway/interstate lanes and direct connections, and provides complete interchange lighting of all interchanges within the section. If one of the lighting warrants in the below table is satisfied, then continuous freeway/interstate lighting may be installed at the option of NDDOT.

- 1A Sections in and near cities where the freeway/interstate mainline current AADT $\geq 30,000$.
- 1B Sections where three or more successive interchanges are located with an average spacing of 1.5 miles or less, and adjacent areas outside the right-of-way are substantially urban in character.

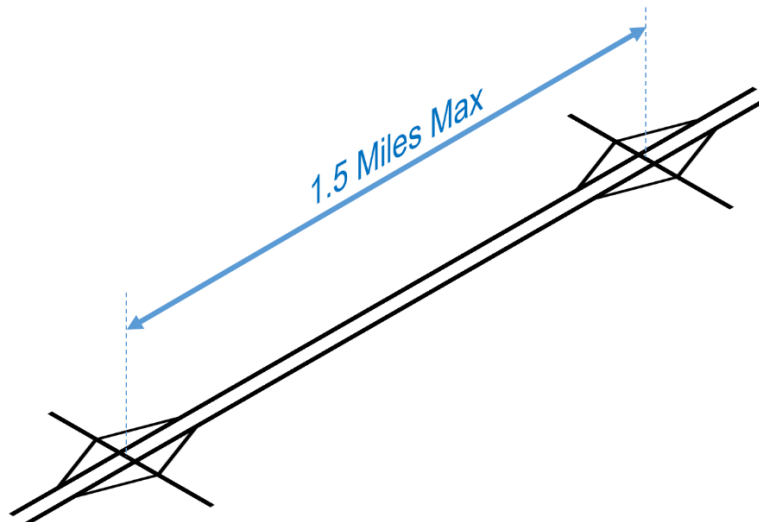

- 1C Sections of two miles or more passing through a substantially developed suburban or urban area in which one or more of the following conditions exist.
- 1 Local traffic operates on a complete street grid having some form of street lighting, parts of which are visible from the freeway/interstate.
 - 2 The freeway/interstate passes through a series of developments that are lighted, such as: residential, commercial, industrial and civic areas, colleges, parks, terminals, etc. that include lighted roads, streets, parking areas, yards, etc.
 - 3 Separate cross streets, either grade separations or interchange crossroads, occur with an average spacing of 0.5 miles or less, some of which are lighted as part of the local street system.
 - 4 The freeway/interstate cross section elements, such as median and borders, are substantially reduced in width below desirable sections used in relatively open country.
- 1D Sections between completely lighted interchanges with a crossroad-to-crossroad spacing of 1.5 miles or less.
- 1E Sections where lighting is recommended based on engineering judgment as part of a traffic operations study.
- 1F Sections where an existing continuous freeway/interstate lighting system is removed due to a roadway construction project.

References:

1. AASHTO, "[Roadway Lighting Design Guide](#)", October 2005.

LIGHTING WARRANTS (CONTINUED)

2 Complete Interchange Lighting Warrant

Complete interchange lighting provides relatively uniform lighting within the limits of an interchange, including: main lanes, direct connections, ramp terminals, frontage road or crossroad intersections. If one of the lighting warrants below is satisfied, then complete interchange lighting may be installed at the option of NDDOT.

- 2A Where continuous freeway/interstate lighting is installed.
- 2B Where the total current AADT ramp traffic entering and leaving the freeway/interstate within the interchange area $\geq 10,000$ for urban conditions, 8,000 for suburban conditions, or 5,000 for rural conditions.
- 2C Where the current AADT on the crossroad $\geq 10,000$ for urban conditions, 8,000 for suburban conditions, or 5,000 for rural conditions.
- 2D Where existing substantial commercial or industrial development that is lighted during hours of darkness is located in the immediate vicinity of the interchange, or where the crossroad is lighted for 0.5 mile or more on each side of the interchange.
- 2E Where lighting is recommended based on engineering judgment as part of a traffic operations study.
- 2F Where an existing complete interchange lighting system is removed due to a roadway construction project.
- 2G Where a local governmental agency agrees to pay 50% of the installation costs and 100% of the maintenance and operating costs.

3 Partial Interchange Lighting Warrant

Partial Interchange Lighting provides illumination only of decision-making areas, including: mainline merge and diverge areas, ramp terminal intersections, other areas of nighttime hazard (such as raised medians on the crossroad). The figures below show examples of partial interchange lighting. If one of the lighting warrants below is satisfied, then partial interchange lighting may be installed at the option of NDDOT.

- 3A Where complete interchange lighting is warranted, but not initially fully installed, a partial lighting system that exceeds the normal partial installation in number of lighting units is considered justified.
- 3B Where the total current AADT ramp traffic entering and leaving the freeway/interstate within the interchange area $\geq 5,000$ for urban conditions, 3,000 for suburban conditions, or 1,000 for rural conditions.
- 3C Where the current AADT on the freeway/interstate through traffic lanes $\geq 25,000$ for urban conditions, 20,000 for suburban conditions, or 10,000 for rural conditions.
- 3D Where lighting is recommended based on engineering judgment as part of a traffic operations study.
- 3E Where an existing partial interchange lighting system is removed due to a roadway construction project.
- 3F Where a local governmental agency agrees to pay 50% of the installation costs and 100% of the maintenance and operating costs.

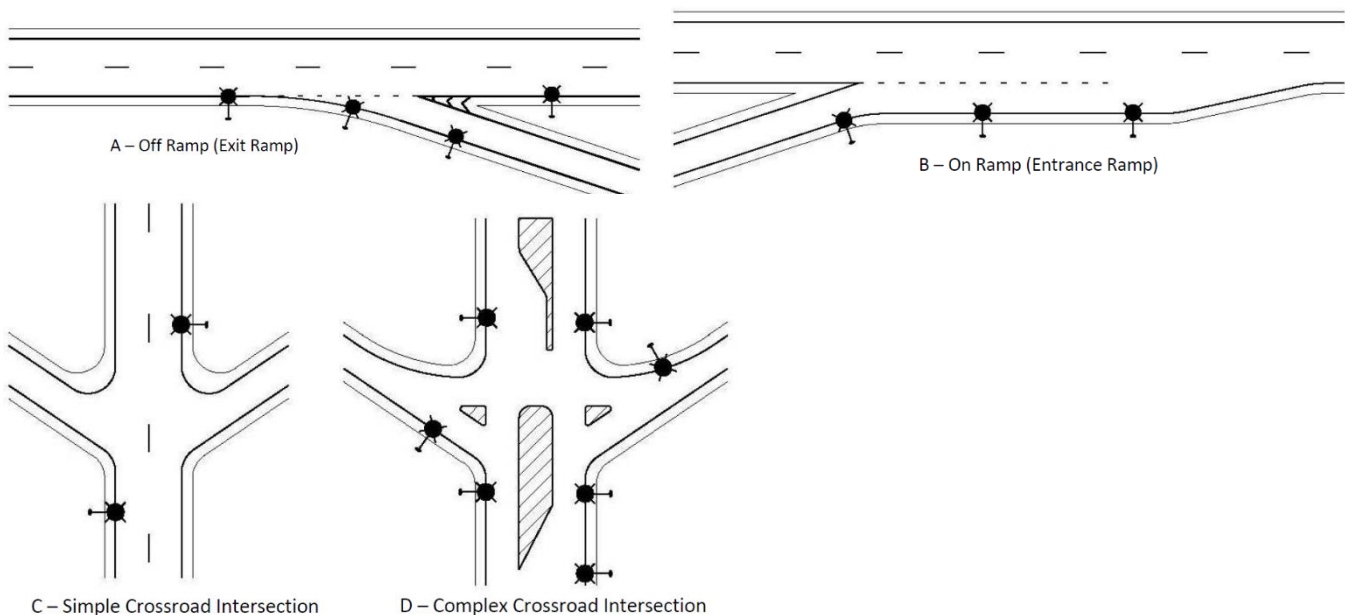

LIGHTING WARRANTS (CONTINUED)

4 Roadway Segment (non-freeway) Lighting Warrant

A lighting system is provided with uniformity values and average illuminance values in accordance with the current edition of AASHTO’s Roadway Lighting Design Guide. Illumination lighting is provided at intersections within the segment. If one of the lighting warrants below is satisfied, then roadway segment lighting (non-freeway) may be installed at the option of NDDOT.

- 4A Sections where curb and gutter are present on at least one side of the road.
- 4B Sections through cities where substantial development is present on both sides of the road and one of the below criteria is also satisfied:
 - 1 The highway’s [Highway Performance Classification System](#) is Interregional or State Corridor, or
 - 2 The major road current AADT (two-way volume) is 1,000 or more.

For warrant 4B, the Highway Performance Classification System map can be found on NDDOT’s Website and the below questions may be considered when determining whether or not “substantial development” is present on both sides of the road:

- Is development fairly continuous for multiple blocks along both sides of the road or is it limited to isolated spot locations?
- Are significant traffic volumes generated on both sides of the road?
- Is traffic drawn from one side to the other at multiple intersections (traveling perpendicular across the major road)?



North-South is the major road. Substantial development present on east side but not west side.

East-West is the major road. Substantial development present on both sides.



- 4C Sections between two fully illuminated intersections that are spaced 0.75 mile apart or less.

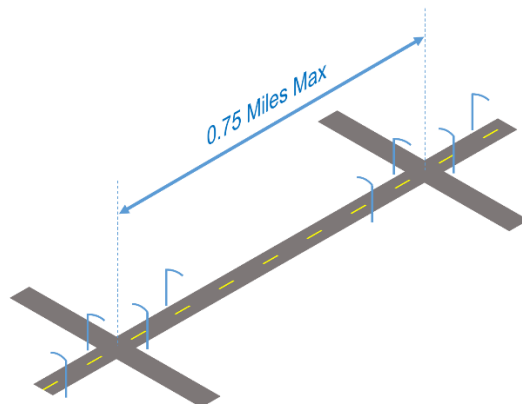

- 4D Sections where lighting is recommended based on engineering judgment as part of a traffic operations study.
- 4E Sections where an existing roadway segment lighting system is removed due to a roadway construction project.
- 4F Sections where a local governmental agency agrees to pay 50% of the installation costs and 100% of the maintenance and operating costs.

LIGHTING WARRANTS (CONTINUED)**5 Illumination Lighting Warrant**

A lighting system is provided that illuminates the entire intersection area, through the full width turn bays and partially into the turn lane tapers. Uniformity values and average illuminance values are in accordance with the current edition of AASHTO's Roadway Lighting Design Guide. If one of the lighting warrants below is satisfied, then intersection illumination lighting may be installed at the option of NDDOT.

- 5A All signalized intersections.
- 5B All roundabout intersections and all reduced conflict intersections
- 5C Where raised channelizing islands/medians are present.
- 5D Where roadway segment lighting is installed.
- 5E Rural and suburban intersections where the current traffic volume cross product (Major AADT x Minor AADT) is 10,000,000 or more.
- 5F Where lighting is recommended based on engineering judgment as part of a traffic operations study.
- 5G Where an existing illumination lighting system is removed due to a roadway construction project.
- 5H Where a local governmental agency agrees to pay 50% of the installation costs and 100% of the maintenance and operating costs.



LIGHTING WARRANTS (CONTINUED)**6 Destination Lighting Warrant**

Destination lighting typically consists of one wood pole street light at two-lane highway intersections and two wood pole street lights at divided highway intersections. The light alerts drivers to the presence of the intersection and can also act as a navigation reference point. Even during the daytime, the light pole provides a visual cue to the driver to be alert for possible conflicting vehicle movements. Destination lighting may not be as effective where there is existing surrounding ambient lighting. If one of the lighting warrants below is satisfied, then intersection destination lighting may be installed at the option of NDDOT.

- 6A Where lighting is recommended based on the Highway Safety Improvement Program Implementation Plan or the Local Road Safety Program.
- 6B Where the current traffic volume cross product (Major AADT x Minor AADT) is 2,000,000 or more.
- 6C Where an overhead span-wire flashing beacon system is removed.
- 6D Where lighting is recommended based on engineering judgment as part of a traffic operations study.
- 6E Where an existing destination lighting system is removed due to a roadway construction project.
- 6F Where a local governmental agency agrees to pay 50% of the installation costs and 100% of the maintenance and operating costs.

**Guidelines for the Installation of Banners on Light Standards**

- Banners cannot interfere with any official traffic control devices.
- Banners must not look like a traffic control device.
- Under the Highway Beautification Act of 1965, it is illegal for any private or commercial business to advertise on highway right-of-way. The banners can not contain any form of advertising for private or commercial business.
- There are no specified mounting height requirements for banners on light standards at this time. A distance of 10 feet from the bottom of the banner to allow for pedestrians and vehicles to pass under is recommended. Mounting brackets should be hinged and allow for rotation if the banner is struck.
- The maintenance of the banners and mounting hardware would be the responsibility of the local road authority. The NDDOT will not be responsible for any banners.
- The manufacturer or the owner of the light standard/utility pole must verify that the pole is structurally sound to support the banner.
- Recommend that they only be installed within city limits and in a reduced speed zone.

OVERHEAD FLASHING BEACON

Recent information obtained from NDDOT engineering and safety partners is leading the department away from the use of overhead flashing beacons. Review of existing information indicates no proven crash reduction after installation of these devices. Other countermeasures are available to reduce intersection crashes that have the potential to be more effective.

The overhead flashing beacon removal process is as follows:

1. Existing overhead flashing beacons are identified by District Engineers and Traffic Operations
2. Traffic operations identifies intersection treatments after the beacon is removed. Typically the base treatments include the following items:
 - a. Destination light (NDDOT Lighting warrant 6C is met)
 - b. Stop bar
 - c. "STOP AHEAD" pavement markings
 - d. Larger stop sign (36" x 36" or larger) with higher retroreflective sheeting
 - e. Stop-ahead sign (W3-1)
 - f. Intersection rumble strips
 - g. Double arrow sign (for T-intersections only)
3. If the intersection is determined to have a severe crash history and/or identified as a "high risk" in the SRSP, additional 2nd tier treatments may be considered in addition to the base treatments:
 - a. Flashing beacon stop sign or flashing LED stop sign
 - b. Intersection warning sign(s) on the major road – such as W2-1, W2-2
4. If the district engineer agrees with the proposed treatments, the intersection improvements will be programmed into the STIP either through a standalone HSIP project, or integrated into other programmed projects.
5. Where traffic operations and the district engineer agree that more substantial improvements are needed (beyond the 1st and 2nd tier treatments), a traffic operations study should be done to look at other countermeasures (ICWS, RCI, Roundabout, etc.).

PEDESTRIAN CROSSWALK ANALYSIS

An engineering study is performed before a marked crosswalk is installed at a location away from a traffic signal or an approach controlled by a stop or yield sign. A city or local governmental agency must submit the request to ensure they support the project, because they will be required to assume the maintenance of the improvement after it is installed. After a request for a pedestrian facility is submitted to NDDOT, traffic operations staff will review the request to ensure the location meets guidelines for installing a pedestrian crossing. Typically this review involves looking at any crash history, the number of pedestrians crossing the roadway, the width of the roadway, sidewalk connectivity leading to and from the proposed location and existing nearby pedestrian crossings. Refer to the *ND Moves*⁴ plan for more information.

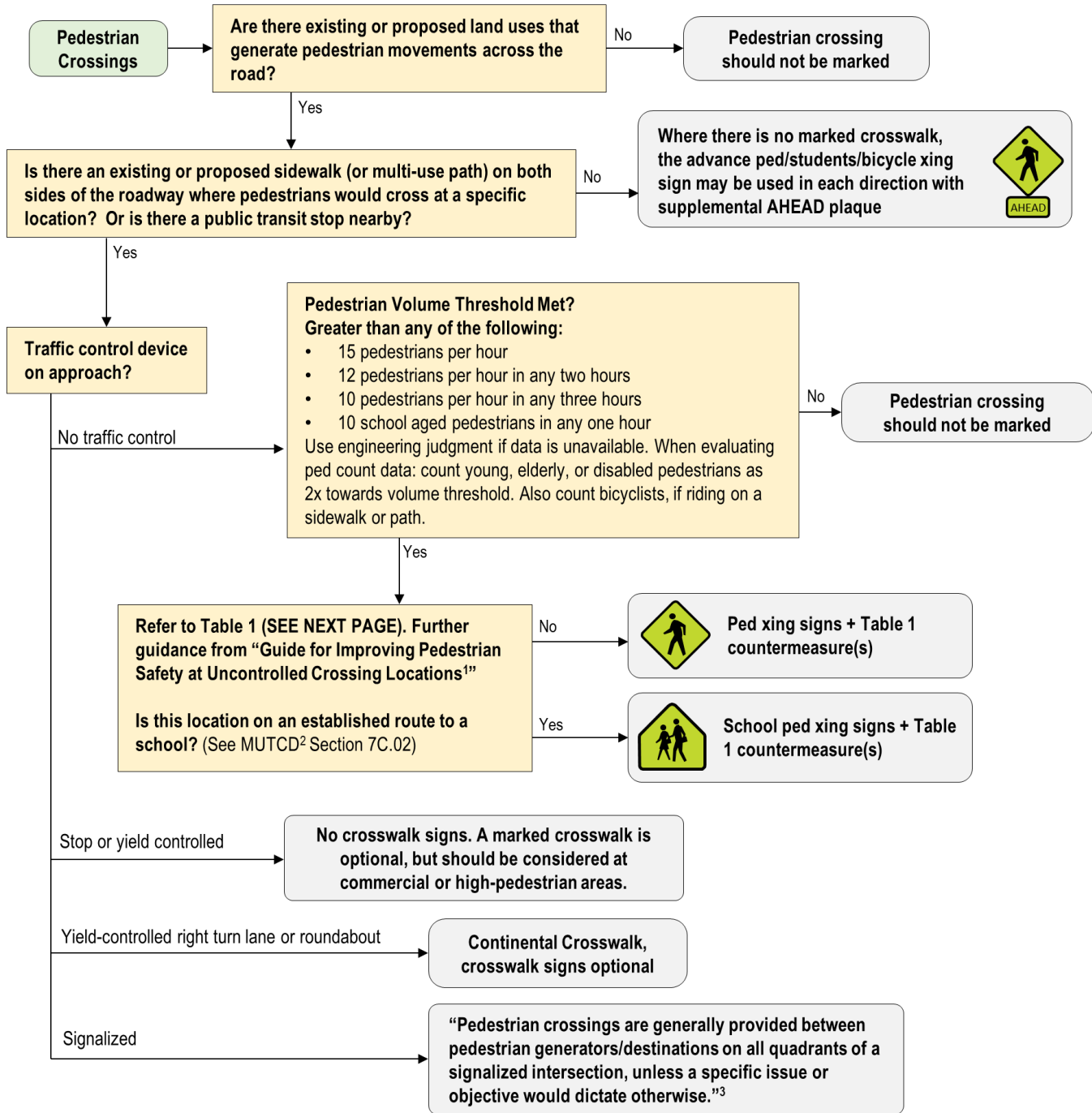

References:

1. FHWA, "[Guide for Improving Pedestrian Safety at Uncontrolled Crossing Locations](#)", 2018
2. FHWA, "[Manual on Uniform Traffic Control Devices](#)", 2009.
3. FHWA, "[Signal Timing Manual, 2nd Edition](#)", 2015.
4. NDDOT, "[Active and Public Transportation Facility Planning Best Practices Recommendations](#)", April 2019. See page 55.

PEDESTRIAN CROSSWALK TREATMENTS

TABLE 1		Vehicle AADT < 9,000			Vehicle AADT 9,000-15,000			Vehicle AADT > 15,000		
		≤30	30-40	≥40	≤30	30-40	≥40	≤30	30-40	≥40
Roadway Configuration	2 lanes (1 lane in each direction)	1 2 4 5 6	1 7 9	1 5 6 7 9	1 4 5 6	1 7 9	1 5 6 7 9	1 4 5 6	1 7 9	1 5 6 7 9
	3 lanes with raised median (1 lane in each direction)	1 2 3 4 5	1 3 7 9	1 3 5 6 7 9	1 3 4 5	1 3 7 9	1 3 5 6 7 9	1 3 4 5	1 3 7 9	1 3 5 6 7 9
	3 lanes without raised median (1 lane in each direction with a two-way left turn lane)	1 2 3 4 5 6 7 9	1 3 5 6 7 9	1 3 5 6 7 9	1 3 4 5 6 7 9	1 3 5 6 7 9	1 3 5 6 7 9	1 3 4 5 6 7 9	1 3 5 6 7 9	1 3 5 6 7 9
	4+ lanes with raised median (2 or more lanes in each direction)	1 3 5 7 8 9	1 3 5 7 8 9	1 3 5 8 9	1 3 5 7 8 9	1 3 5 7 8 9	1 3 5 7 8 9	1 3 5 7 8 9	1 3 5 8 9	1 3 5 8 9
	4+ lanes without raised median (2 or more lanes in each direction)	1 3 5 6 7 8 9	1 3 5 6 7 8 9	1 3 5 6 8 9	1 3 5 6 7 8 9	1 3 5 6 7 8 9	1 3 5 6 7 8 9	1 3 5 6 7 8 9	1 3 5 6 8 9	1 3 5 6 8 9













This Table adapted from Table 1 in the "Guide for Improving Pedestrian Safety at Uncontrolled Crossing Locations" from FHWA.

The colored boxes indicate the suggested countermeasure(s). The absence of a number signifies that the countermeasure is generally not an appropriate treatment, but exceptions may be considered following engineering judgment.

Signifies that the countermeasure is a candidate treatment

Signifies that the countermeasure should always be considered, but not mandated or required, based on engineering judgment

1 Signifies that crosswalk visibility enhancements should always occur in conjunction with other identified countermeasures.

<p>1 Crosswalk Visibility Enhancements</p> <p>High-visibility Crosswalk Markings "Continental Style" A continental style crosswalk may be used when extra emphasis is needed; such as for midblock crosswalks, crosswalks across uncontrolled roadways, or crosswalks across a yield-controlled right turn lane at a signalized intersection (see continental crosswalk detail—NDDOT standard drawing D-762-1).</p> <p>Pedestrian Crosswalk Warning Signs W11-2 for pedestrian crosswalks, S1-1 for school crosswalks. A diagonal downward arrow (W16-7) plaque is used to point to the crosswalk location</p> <p>Parking Restrictions on Crosswalk Approach Minimum parking setback 20 ft in advance of crosswalk where speeds are 25 mph or less, 30 ft where speeds are between 26 and 35 mph</p> <p>Adequate Nighttime Lighting Levels Place lights in advance of midblock and intersection crosswalks on both approaches to illuminate the front of the pedestrian and avoid creating a silhouette</p>	<p>4 In-Street Pedestrian Crossing Sign Local agency must approve these with a plan for maintenance and prompt replacement of damaged signs</p> <p>5 Curb Extension Also called "bulb-outs", these increase visibility of pedestrians and help reduce crossing distance</p> <p>6 Pedestrian Refuge Island Ideal for crossing multiple lanes and/or at midblock locations</p> <p>7 Rectangular Rapid-Flashing Beacon (RRFB) Pedestrian actuated LEDs are particularly effective at multilane crossings with speed limits less than 40 mph. Consider overhead-mounted RRFB for long crossings and/or with multiple lanes</p> <p>8 Road Diet If recommended, a traffic study should be done to evaluate the entire corridor where the road diet is proposed</p> <p>9 Pedestrian Hybrid Beacon (PHB) Ideal for midblock locations but may be used at intersections, further guidance in MUTCD Chapter 4F. If a PHB is determined to be infeasible, RRFB's may be considered.</p>
<p>2 Raised Crosswalk Appropriate for local or collector streets, not arterials</p> <p>3 Advance Yield Here to Pedestrians Sign and Yield Line Ideal for midblock locations or where there are multiple lanes</p>	           

LED STOP SIGNS

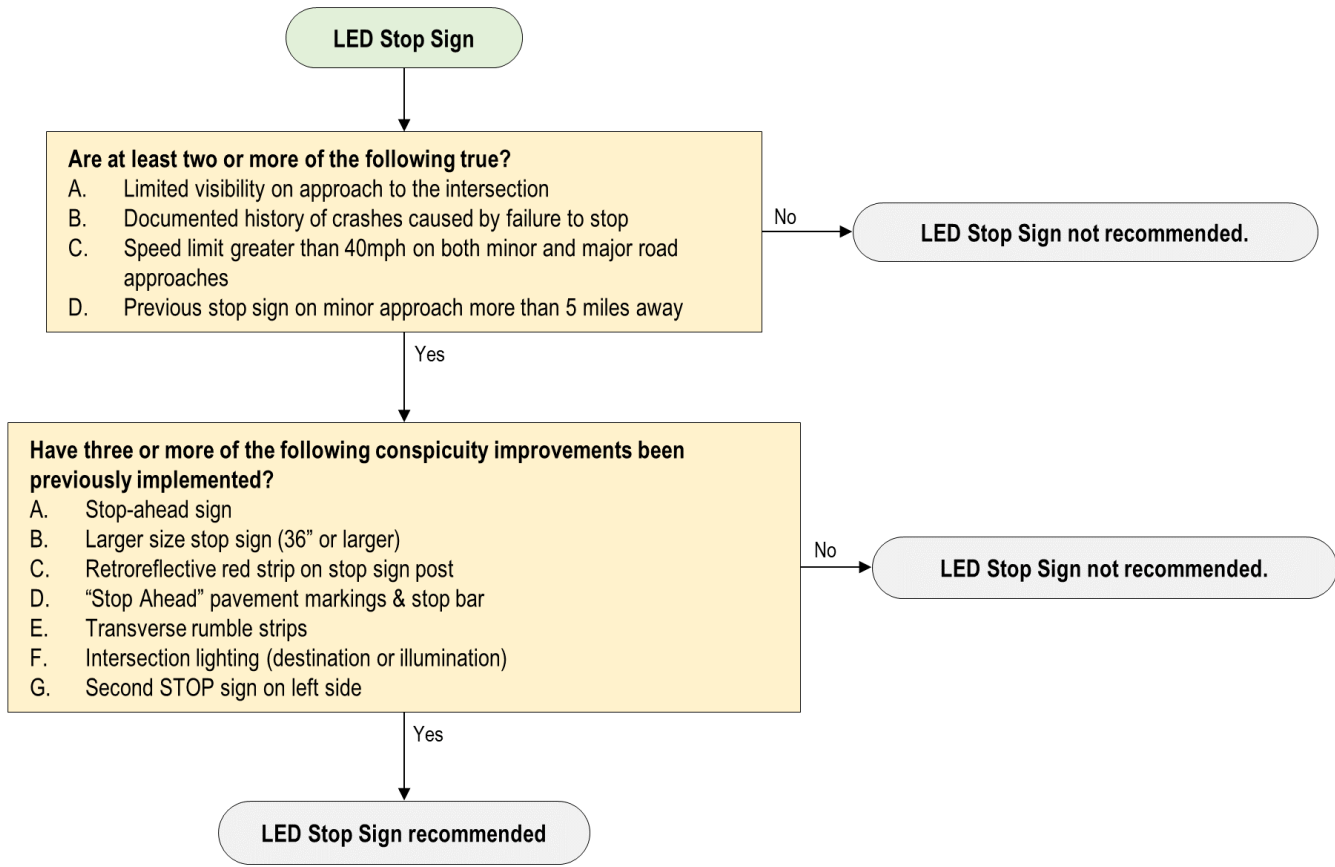

TURN LANES

The flowcharts on the following pages should be used to determine whether a turn lane should be recommended in the traffic study. Turn lanes considered based on traffic volumes should be based on the type of project as follows:

Type of Project	Turn lane warrants based on:
New/Reconstruction	Projected 20-year traffic
Major Rehabilitation	Projected 20-year traffic
Structural Improvement	Projected 20-year traffic
Minor rehabilitation	Current traffic
Preventive Maintenance	Current traffic
No project planned (REF95 request)	Current traffic
New Development	Projected traffic for opening year of development

If the turn lane warrants are met at a location where a turn lane does not exist, then recommend a new turn lane be built. If there are existing turn lanes at the same location that do not meet design standards, and do meet turn lane warrants, then recommend to extend these turn lanes to meet design standards. If there is a turn lane at this same location that does not meet design standards and does not meet turn lane warrants, then do not recommend to extend. If there are existing turn lanes at a location that do not meet design standards and/or do not meet turn lane warrants, then do not recommend the turn lanes to be extended. If there are conditions where engineering judgment may need to be exercised, then the engineer may make a recommendation to build new or extend existing turn lanes as long as proper justification is made.

Left Turn Lane Offsets

Left turn lanes are sometimes installed with a negative offset, especially at divided highway intersections. However, as appropriate, a traffic operations study may recommend that opposing left turn lanes be installed with zero offset or positive offset (Figure 5) based on engineering judgment. Positive offset left turn lanes improve the visibility of oncoming through traffic, allow left-turning drivers to utilize the available gaps more effectively, and decrease the possible conflict between opposing left-turning vehicles. If feasible, positive offset or zero offset left turn lanes should be installed at:

- intersections with left turn crash trends,
- intersections with sight distance issues,
- unsignalized intersections where the mainline left turn lanes each have a left turn PCE of 300 or more,
- signalized intersections with permissive-only or protected-permissive left turn phasing.

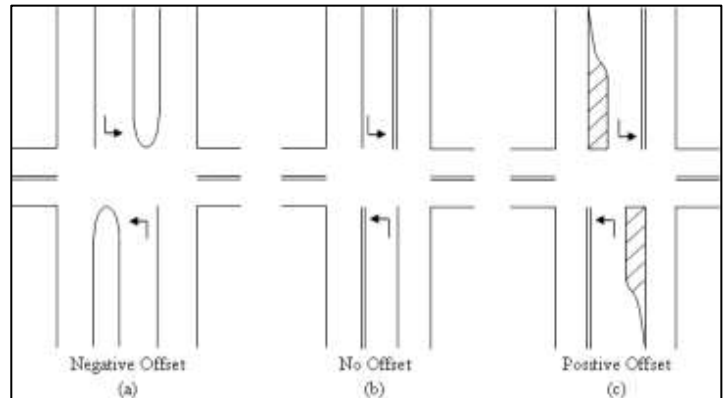

Right Turn Lane Offsets

Right turn lanes are typically installed adjacent to the through lane. However, as appropriate, a traffic operations study may recommend that an offset right turn lane (Figure 6) be installed based on engineering judgment. Offset right turn lanes give drivers on the minor approach (at the stop bar) an unobstructed view of through traffic in the near lanes, which allows for more effective use of gaps. When implementing offset right turn lanes, ensure the horizontal geometry of the roadway does not negate the line-of-sight improvement. Some examples of locations where offset right turn lanes may be beneficial are:

- intersections where a crash trend (susceptible to correction by an offset right turn lane) has been identified,
- intersections with large volumes of turning trucks, or
- intersections with sight distance issues.



TURN LANES (CONTINUED)

Cost Participation and Programming of Turn Lane Installation

Locations where the development is pre-existing that meet guidance shall be funded by NDDOT. Proposed development locations that meet guidance may be funded by the local governmental agency in conjunction with the zoning and platting process if immediate installation is desired. Otherwise, NDDOT will consider funding installation and follow project programming. Timing of turn lane installation is dependent upon multiple factors, such as: availability of funds, the approval process, weather, possibly waiting so the turn lane installation can be tied to an upcoming construction project, etc. If NDDOT is paying to install a turn lane and if there is an upcoming project in the STIP (Statewide Transportation Improvement Program), consideration should be given to installing the turn lane as part of the upcoming project (typically using the project’s funding, rather than HSIP funding).

Turn Lane Design

New turn lanes shall be designed according to section III-03.05.01 of NDDOT’s Design Manual. Plans and specifications for all turn lanes to be installed off of or onto state highways shall be subject to approval by NDDOT. Turn lanes, including the taper area, should be kept clear of any additional points of access. Section III-16 of the NDDOT Design Manual discusses driveways and access management.

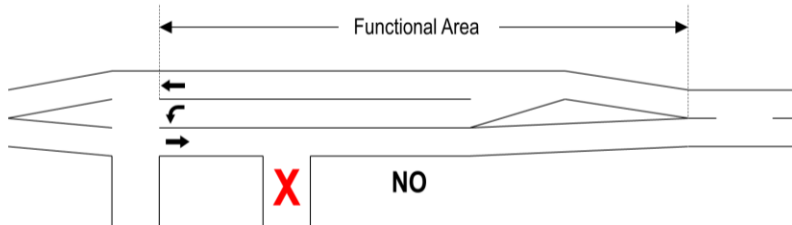
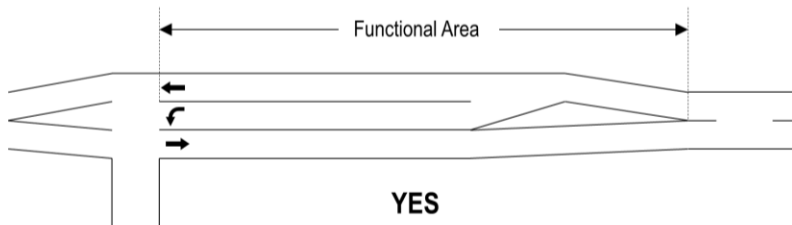
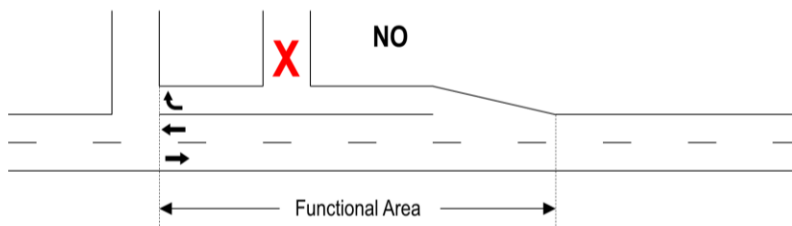
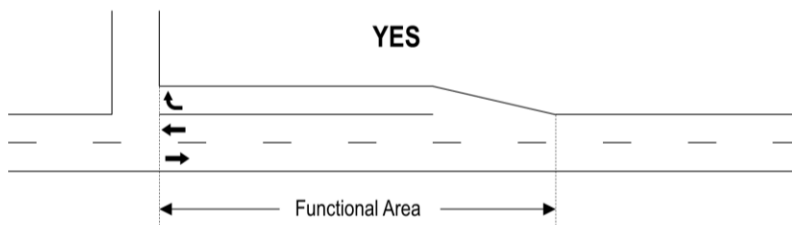

LEFT TURN LANE

The flowchart below should be used to determine whether a left turn lane should be recommended in the traffic study. Dual left turn lanes should be considered at signalized intersections if the left turn volumes exceed 300 vehicles per hour. Where dual left turn lanes are recommended, dual *receiving* lanes are necessary and are typically 15 feet wide.

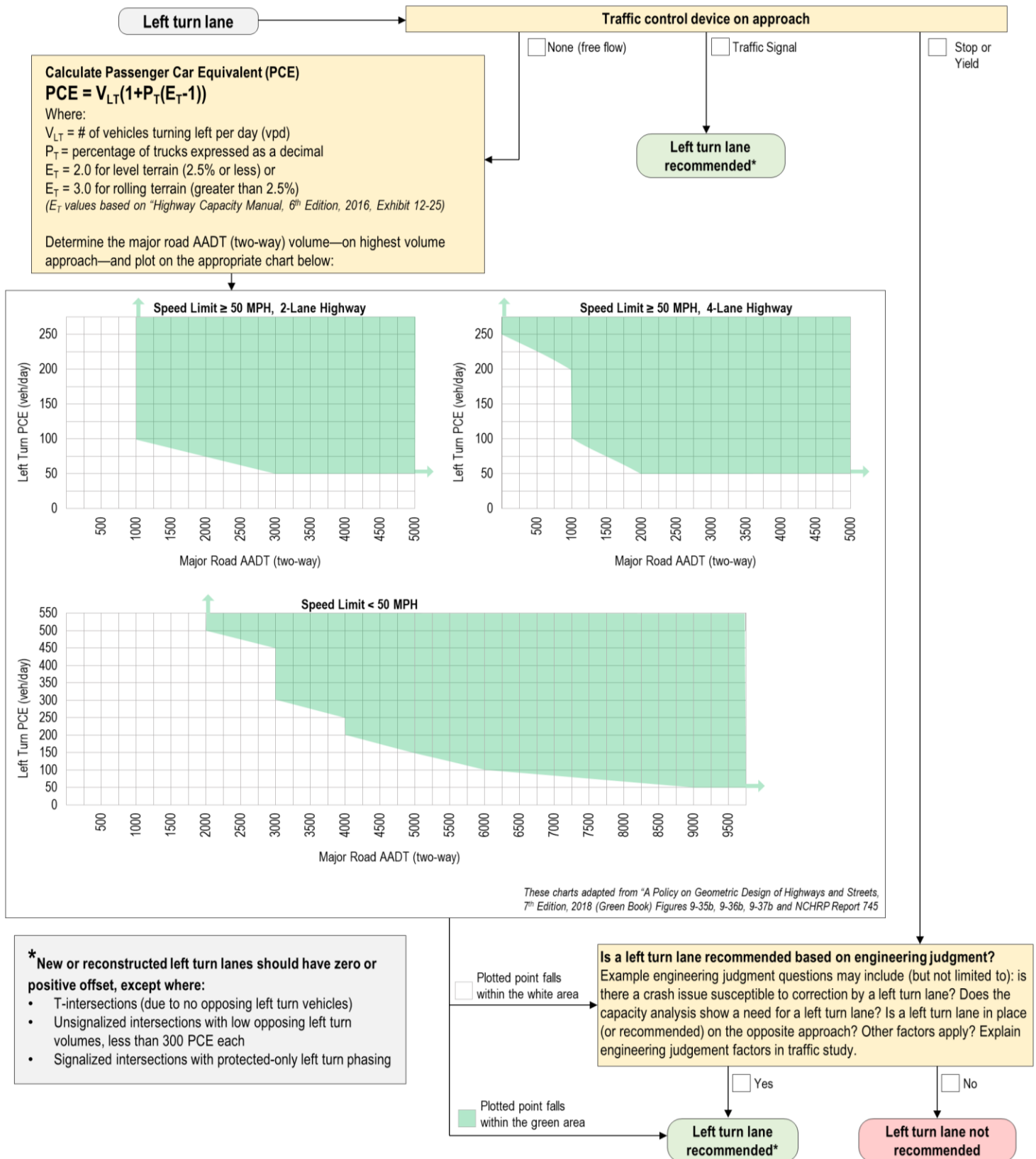

RIGHT TURN LANE

The flowchart below should be used to determine whether a right turn lane should be recommended in the traffic study.

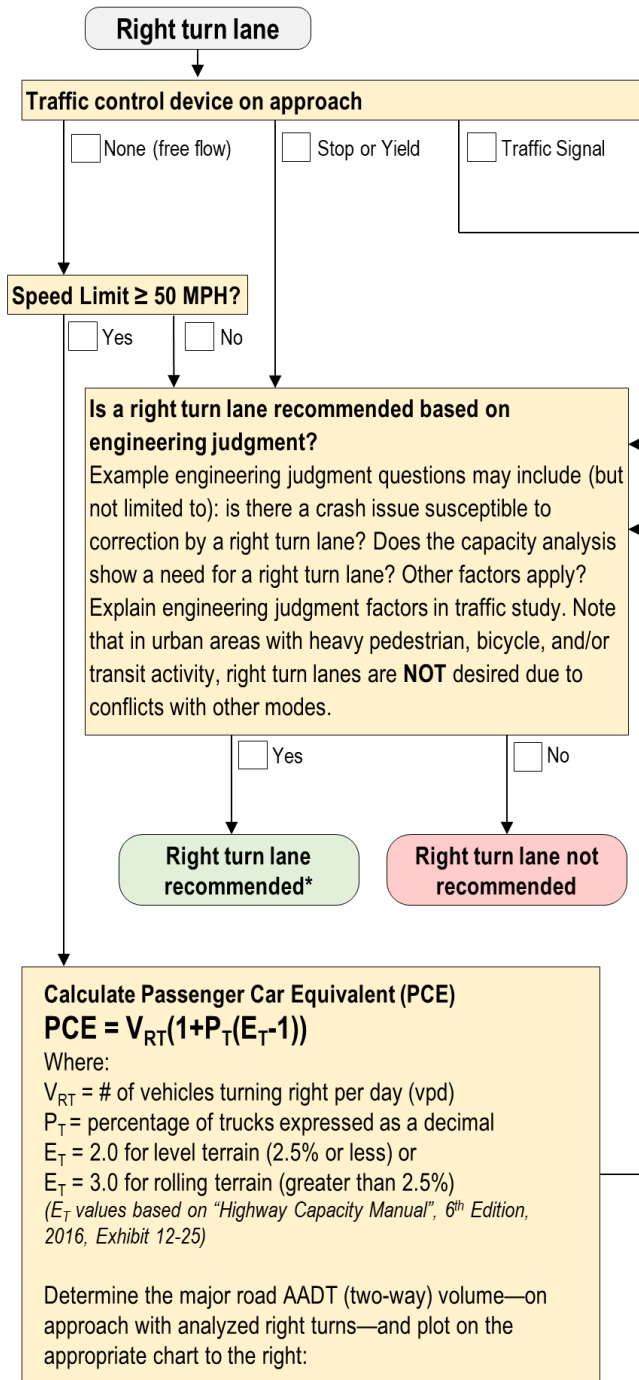

Signalized Intersections

If the number of right Turning Vehicles in a one-hour period is greater than the value shown below, then a right turn lane is recommended:

Speed Limit (mph)	Right turns (veh/hr)
20	300
25	300
30	250
35	200
40	150
45	100
50	50
55	50

From "Highway Capacity Manual", 6th Edition, 2016, Page 19-33

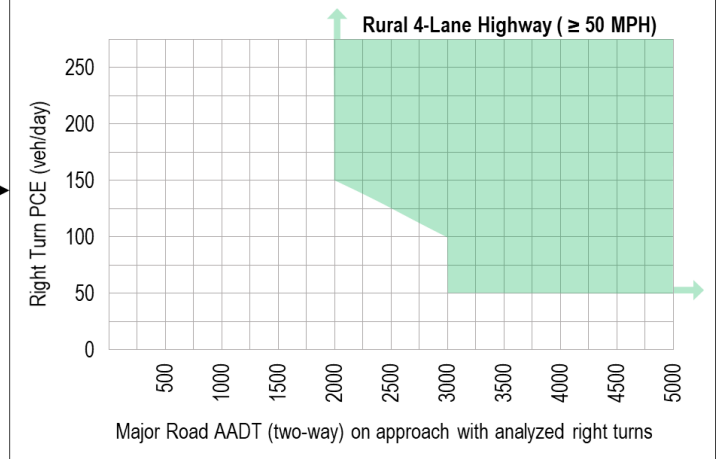
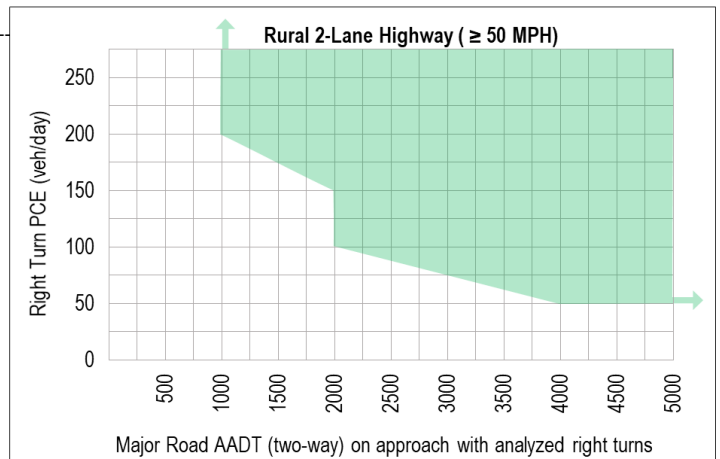

- Right turn lane recommended*
- Right turn lane not recommended except per engineering judgment

***The study should indicate any need for offset right turn. Typical questions to determine appropriate locations for an offset right turn lane:**

- Crash trends identified that are susceptible to correction by an offset right turn lane?
- Large volume of truck turning traffic?
- Sight distance issues?

These charts adapted from "A Policy on Geometric Design of Highways and Streets, 7th Edition, 2018 (Green Book) Figures 9-36a, 9-37a and NCHRP Report 745

TURN LANE LENGTH

Uncontrolled Approach

An uncontrolled turn lane is defined as any turn lane in which no traffic signals or signs are used to control traffic movement within the turn lane¹. Details on the design of the turn lane geometry can be found in the NDDOT Design Manual Section III-03.05.01. The storage distance (L4) is the most important value that is needed by readers of the traffic operations study. The storage length procedure is described below. Other turn lane design elements (L1, L2, L3, L5 from the NDDOT Design Manual¹) may be necessary in the development of a traffic study.

Right turn at uncontrolled approach

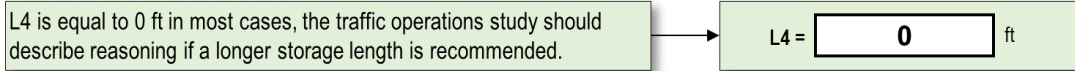

Left turn at uncontrolled approach

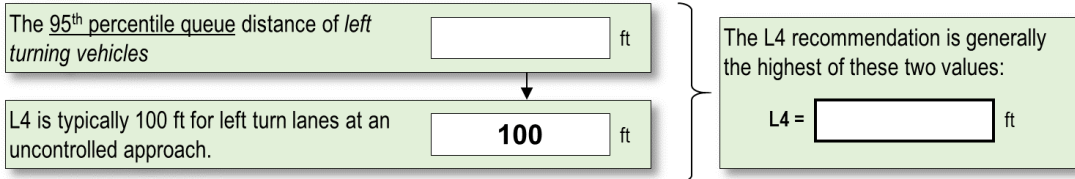

The study should indicate if left turn lanes are to be designed with a positive offset and if right turn lanes are to be designed with an offset (these items relate to providing proper sight distance).

Controlled Approach

For a turn lane on an approach that is controlled by a stop sign, yield sign or traffic signal, the traffic operations study will indicate the recommended “full-width length” of the turn lane¹. The recommended length of the turn lanes should take into account impacts to nearby intersections and the overall area context. The traffic study should describe methods used such as capacity analysis, traffic modeling, etc.

Most turn lanes are 100 feet full-width length at stop or yield controlled approaches. If the capacity analysis is LOS F, the 95th percentile length may be much longer and is not a practical recommendation. If it is likely that a traffic signal would be warranted within 20 years, the recommended full-width length may be determined using the signalized approach method.

Traffic Signal

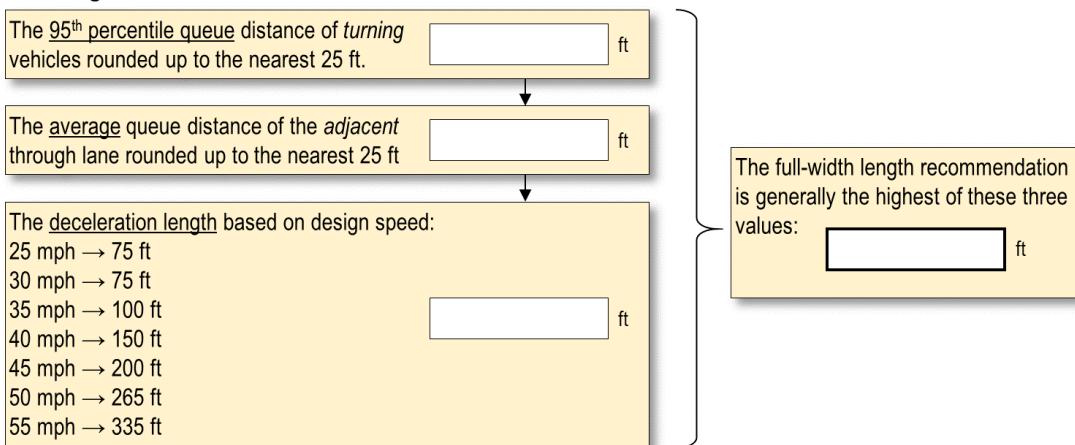

Stop Sign / Yield Sign

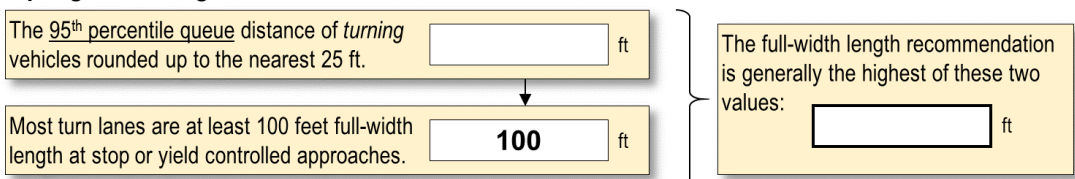

References:

1. NDDOT, “[Design Manual](#),” May 5, 2015. (Section III-03.05.01)

ACCELERATION LANES

An acceleration lane is an auxiliary or speed-change lane that allows vehicles to accelerate to highway speeds before entering the through-traffic lanes of a highway¹.

NDDOT will consider installation of a median acceleration lane (MAL) at intersections on divided highways where all of the following criteria² are met:

1. There is a significant history of rear-end or sideswipe crashes
2. Intersection sight distance is inadequate for left-turning traffic entering the divided highway
3. There is a high volume of left-turning trucks (75 or more per day) entering the divided highway.

Acceleration lanes are generally not installed in urban areas on non-interstate roadways. The NDDOT has found through past history that they are ineffective because motorists generally choose not to use them³.

References:

1. TRB, "[NCHRP Report 500 Volume 5: A Guide for Addressing Unsignalized Intersection Collisions](#)", 2003. (page V-23)
2. TRB, "[NCHRP Report 650: Median Intersection Design for Rural High-Speed Divided Highways](#)", 2010. (page 107)
3. NDDOT, "[Memorandum: 6th Ave SW Approach](#)", January 4, 2005.

TRAFFIC SIGNAL WARRANTS

A signal warrant analysis should be completed for existing signalized intersections when a traffic operations report is needed for a project or when more than preventive maintenance work is being completed on the signal. Traffic signal warrants should be run using existing traffic counts or build-year traffic and not 20-year projected traffic.

Any recommendation for installation of a traffic signal should have documentation on what MUTCD warrants are met. The NDDOT form SFN 7924 should be used to document a signal warrant analysis. This form may be supplemented with printouts from any software or spreadsheet programs used to analyze the warrants. Meeting signal warrants does not in itself require the installation of a traffic signal. Traffic signals in rural areas are discouraged for several reasons including violation of driver expectations and difficulty in servicing and maintaining signals in remote locations¹. If an intersection does not meet signal warrants based on current traffic but is close, it is helpful to decision makers if the author identifies the approximate year a signal may be needed.

When performing a traffic signal warrant analysis, engineering judgment should be used to determine what portion of minor-street right-turning traffic to include. Volume modifications should be documented and explained in the warrant analysis. If the minor-street approach has an existing exclusive right turn lane and right-turning traffic is able to turn onto the major-street with minimal conflict, then the right turn volume is excluded from the warrant analysis. Some points to consider when determining if traffic is able to turn with minimal conflict include, but are not limited to:

- Unsignalized capacity analysis results
- Intersection sight distance
- Crash history
- Truck volumes
- Pedestrian conflicts

If the minor-street approach does not have an exclusive right turn lane, then the right turn volume is typically included in the warrant analysis. However, if it is feasible to install an exclusive right turn lane and right-turning traffic is able to turn onto the major-street with minimal conflict, then the right-turn volume is excluded from the warrant analysis.

References:

1. TRB, "[NCHRP Report 650: Median Intersection Design for Rural High-Speed Divided Highways](#)", 2010 (page 1)

TRAFFIC SIGNAL ANALYSIS

Traffic studies that examine existing signalized intersections or where a traffic signal is recommended typically supply the following information:

- Existing signal timing (cycle length, split times, yellow timing, all-red timing, pedestrian crossing timing and coordination settings such as offset, etc.).
- If known, include the age or installation date of existing signal equipment (an expected lifespan is 20 to 30 years for cables, signal heads, signal poles, mast arms; 10-15 years for video detection systems, controllers and electronic components within the controller cabinet)
- Need for new controller or detection equipment
- Analysis of optimized timings for current traffic and future traffic on the proposed roadway geometry.
- Recommended left turn head type for each approach
- [Left turn phasing type](#)
- Right turn overlaps should be used wherever there is an exclusive right turn lane and the overlapping left turn movement has a 4-section FYA head, 5-section “doghouse” head, or 3-section protected-only left turn head
- The report should indicate whether or not the traffic signal is coordinated with adjacent traffic signals:
 - NOT COORDINATED -- For traffic signals that operate FREE (with vehicle detection) and are NOT coordinated, timing recommendations are not needed. For traffic signals that operate pre-timed (no vehicle detection) and are NOT coordinated, pre-timed splits should be recommended. Typically these splits are only long enough to accommodate pedestrian crossing movements.
 - COORDINATED – see following page.

NDDOT phase number convention

Where the major road runs east-west:

φ1 ↶	φ2 →	φ3 ↷	φ4 ↑
φ5 ↷	φ6 ←	φ7 ↶	φ8 ↓

Where the major road runs north-south:

φ1 ↶	φ2 ↓	φ3 ↷	φ4 →
φ5 ↷	φ6 ↑	φ7 ↶	φ8 ←

Note: On major north-south roads in the City of Minot, use phase 1 for SBL, phase 2 for NB, phase 5 for NBL, phase 6 for SB.

COORDINATED TRAFFIC SIGNALS

Where the study area is a corridor of coordinated signalized intersections, time-of-day (TOD) plans should be provided in the traffic operations study. Time-of-Day (TOD) Plans are typically shown in tables that list when the different coordination patterns start throughout the day. Some examples are shown below.

Day 1 Time of Day Plan		
Pattern	Nickname	Start Time
0	FREE	0:00
111	Low Volume	6:00
211	Noon	9:00
111	Low Volume	19:00
0	FREE	22:00

Day 1 = Weekends (Saturday and Sunday)

Day 2 Time of Day Plan		
Patt.	Nickname	Start Time
0	FREE	0:00
111	Low Volume	6:00
311	AM Peak	7:00
111	Low Volume	8:30
211	Noon	11:00
321	School	15:00
411	PM	16:15
211	Noon	17:45
111	Low Volume	19:00
0	FREE	22:00

Day 2 = Weekdays (Monday - Friday)

Weekdays and weekends typically have different TOD plans. TOD plans are typically developed by matching existing plans (if only studying a fraction of signals within a larger corridor) or by looking at traffic volumes at the busiest intersection(s) within a corridor. Different time-of-day periods should be used when total traffic volumes change significantly or when left turn phasing operations change (such as from permissive-only to protected-permissive). To avoid excessive amounts of transition time between patterns, time-of-day periods should last at least 30 minutes. An example of how to develop a TOD plan is shown below.

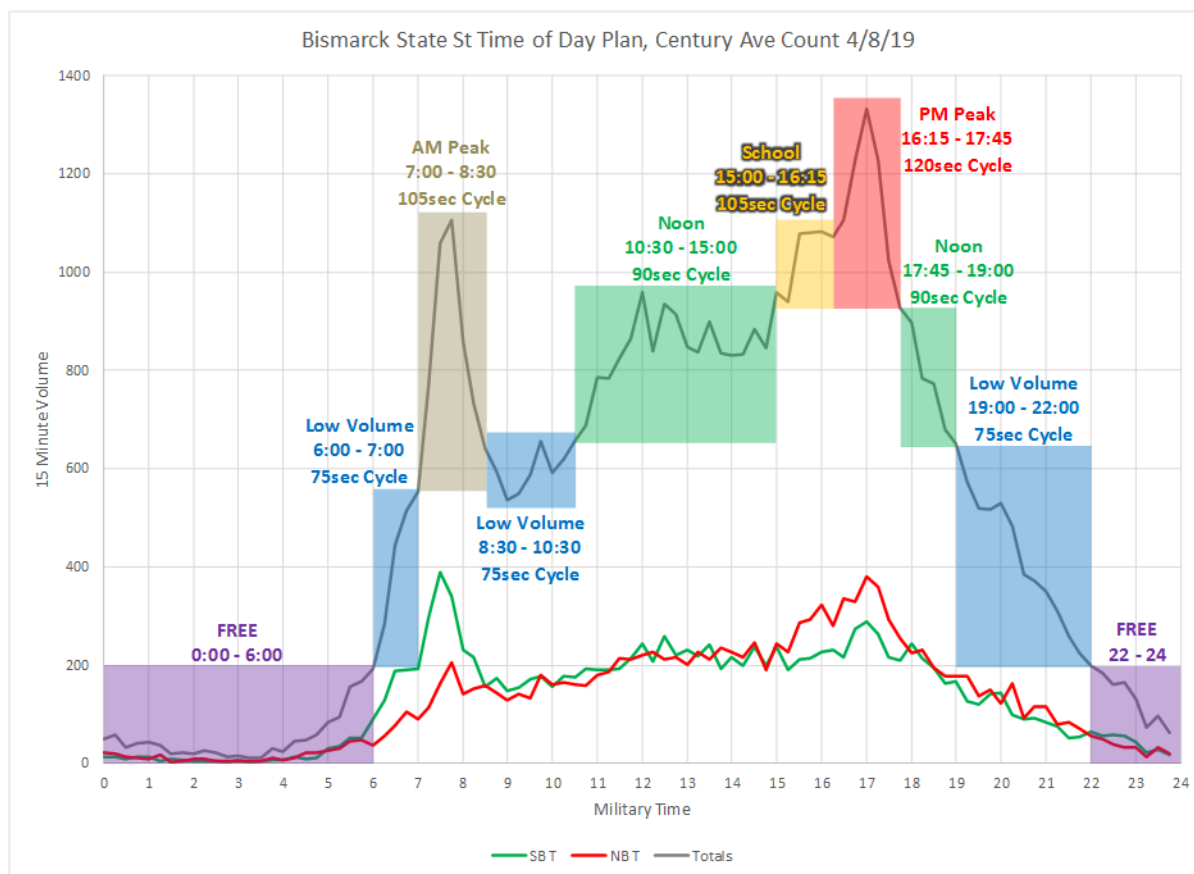

COORDINATED TRAFFIC SIGNALS (CONTINUED)

When determining splits for coordination timings and time-space diagrams, the splits consist of the green, yellow, and all-red time. Splits are programmed into the controller as whole numbers only, no decimals.

Intersection Name = State St & 43rd Ave N												
Coord Plan Pattern	Cycle Length	Coord Offset	Phase Splits (sec)								Lagging L.T. for which Phases	Notes
			1 ←	2 ↓	3 ↙	4 →	5 ↘	6 ↑	7 ↗	8 ←		
111	75	5	25	25	---	25	15	35	---	25	NB L	
211	90	85	30	30	---	30	15	45	---	30	SB L	
311	105	10	25	50	---	30	15	60	---	30	SB L	
321	105	95	30	40	---	35	15	55	---	35	---	
411	120	90	35	40	---	45	20	55	---	45	SB L	
Coordinated Phases:				X				X			Alt Seq #1 = NB L lagging left. Alt Seq #2 = SB L lagging left	

The traffic operations study should show both existing and recommended TOD plans and include any other graphics in the report appendix (such as time-space diagrams, see example below).

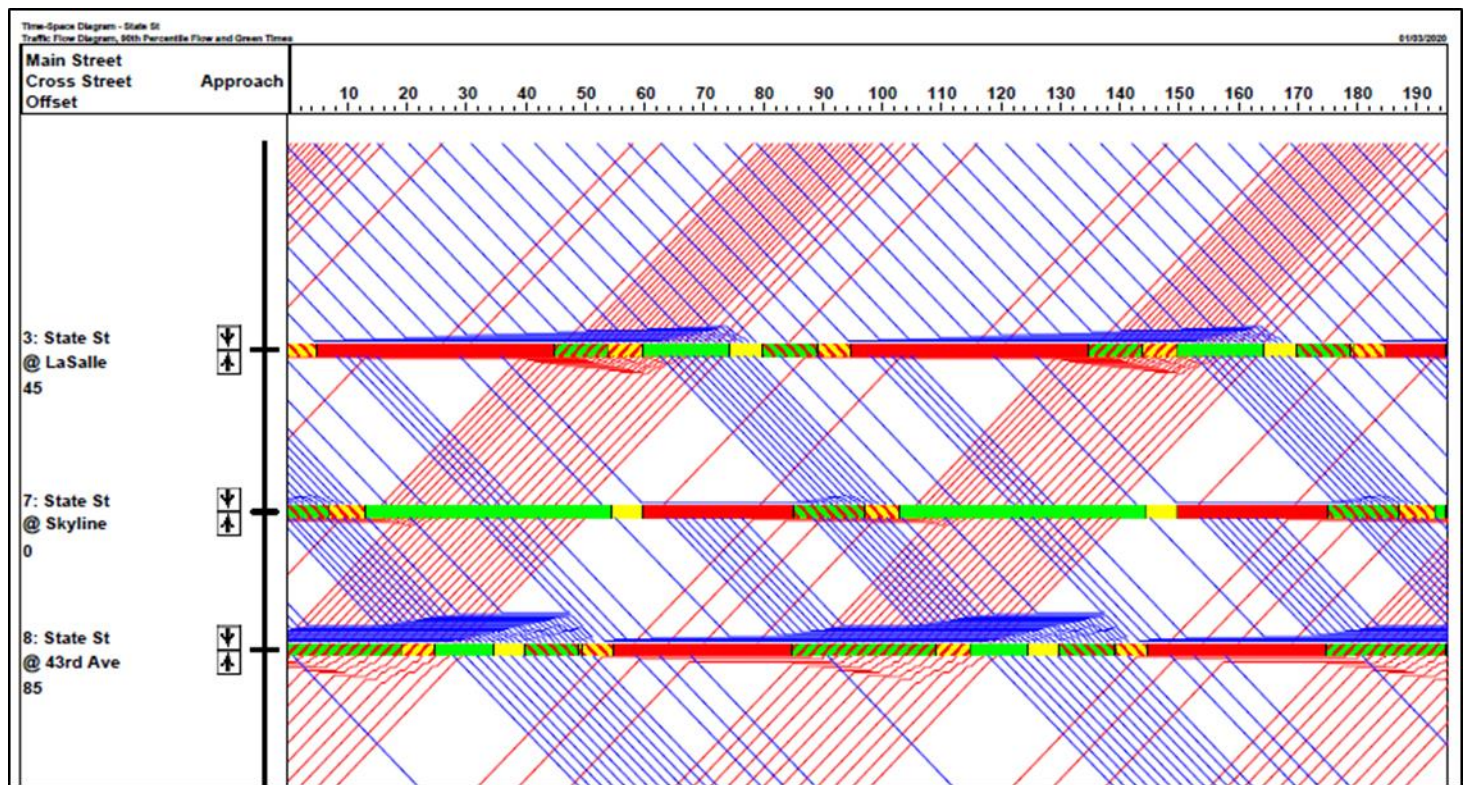

TRAFFIC SIGNALS – COMMON TIMING SETTINGS**General Settings**

Cycle Lengths:	Common cycle lengths are 60sec, 75sec, 90sec, 105sec, and 120sec. The lowest cycle length that can adequately accommodate volumes should be used, because this reduces wait times and queue lengths for side street vehicles and for mainline protected-only left turn phases. 60sec cycles are typically only used when there are no left turn phases.
Yellow Change:	Use NCHRP Report 731 Appendix A (use a speed limit of 30 mph for off-ramps).
Red Clearance:	Use NCHRP Report 731 Appendix A (use a speed limit of 30 mph for off-ramps). The maximum all-red value for ND is 3.0 seconds.
Pedestrian Clearance:	$=(\text{Longest Ped Crossing Distance} \div 3.5\text{ft/sec}) - \text{Buffer Interval}$ <p>Ensure that $(\text{WALK} + \text{Ped Clearance} + \text{Buffer}) \geq [(\text{Longest Crossing Dist} + 6\text{ft}) \div 3.0\text{ft/sec}]$. <i>Note - the term "pedestrian clearance" has different meanings in controller timings versus MUTCD. The controller timing term is the same as MUTCD's term "Pedestrian Change Interval".</i></p>

Coordination Settings

Coordination Splits:	<p>Coordination splits consist of the green, yellow, and all-red time for a movement. They are programmed into the controller as a whole number, no decimals. When developing coordination timings the process can be greatly simplified if the splits and offsets are in increments of 5, similar to speed limits. This also makes field adjustments easier to perform.</p> <p>Rules of thumb for minimum split times (different than Minimum Green times), are: Minimum split for any phase, including a left turn phase = 15sec* Minimum split for an interstate off-ramp = 20sec** Minimum split for a left turn phase accessing an interstate on-ramp = 20sec**</p> <p>*Note, protected left turn phases can be omitted during low volume periods if permissive indications are present. **Note, splits at interchange ramps should be higher due to higher numbers of slow trucks.</p>
Coordination Offsets:	<p>In modern TS2 or ATC controllers, the coordination offset is the point in the cycle when the first coordinated phase turns green. In older TS1 controllers, the offset is the point in the cycle when both coordinated phases are green. This difference is most apparent at interchange intersections where one mainline approach has a left turn arrow and the other mainline approach does not.</p> <p>Within a corridor, program the busiest intersection (or an intersection in the most congested area) to have an offset of zero for all patterns. This will minimize the transition time in the congested area when switching from one coordination pattern to another.</p>
Alternating Lagging Left Turns:	If lagging left turns are available for use, it often works well to alternate which direction has the lagging left turn arrow. For example if an intersection has a lagging left turn for NB, try using a lagging left turn for SB at the next intersection, etc. This trick may not work for closely spaced intersections or for intersections that are far apart.

TRAFFIC SIGNALS – COMMON TIMING SETTINGS (CONTINUED)

Mainline Through Movements (phases 2 and 6)

Minimum Green / Initial:	10 sec (15 sec if mainline speed limit is ≥ 45mph)
Vehicle Extension / Passage Time:	5 sec
Maximum Green:	45 sec
Time Before Reduction:	25 sec
Time to Reduce to Minimum Gap:	5 sec
Minimum Gap:	3 sec
Detector Memory:	Non-Locking if stop bar detectors are present, otherwise use Locking. Note this setting only applies during red indication. During the green indication, all actuations are non-locking.
Phase Recall:	Soft
Dual Entry Enabled:	Yes
Simultaneous Gap Out Enabled:	Yes

Sidestreet Through Movements (phases 4 and 8)

Minimum Green / Initial:	5 sec (10 sec if sidestreet speed limit is ≥ 45mph)
Vehicle Extension / Passage Time:	3 sec
Maximum Green:	30 sec
Detector Memory:	Non-Locking if stop bar detectors are present, otherwise use Locking. Note this setting only applies during red indication. During the green indication, all actuations are non-locking.
Phase Recall:	None
Dual Entry Enabled:	Yes
Simultaneous Gap Out Enabled:	Yes

Protected-Only Left Turn Movements (phases 1,3,5,7)

Minimum Green / Initial:	5 sec
Vehicle Extension / Passage Time:	3 sec
Maximum Green:	25 sec
Detector Memory:	Non-Locking
Phase Recall:	None

Protected/Permissive Left Turn Movements (phases 1,3,5,7)

Minimum Green / Initial:	5 sec
Vehicle Extension / Passage Time:	2 sec
Maximum Green:	20 sec
Detector Memory:	Non-Locking
Phase Recall:	None

LEFT TURN PHASING

This flowchart was adapted from the Signal Timing Manual¹ along with engineering judgment.

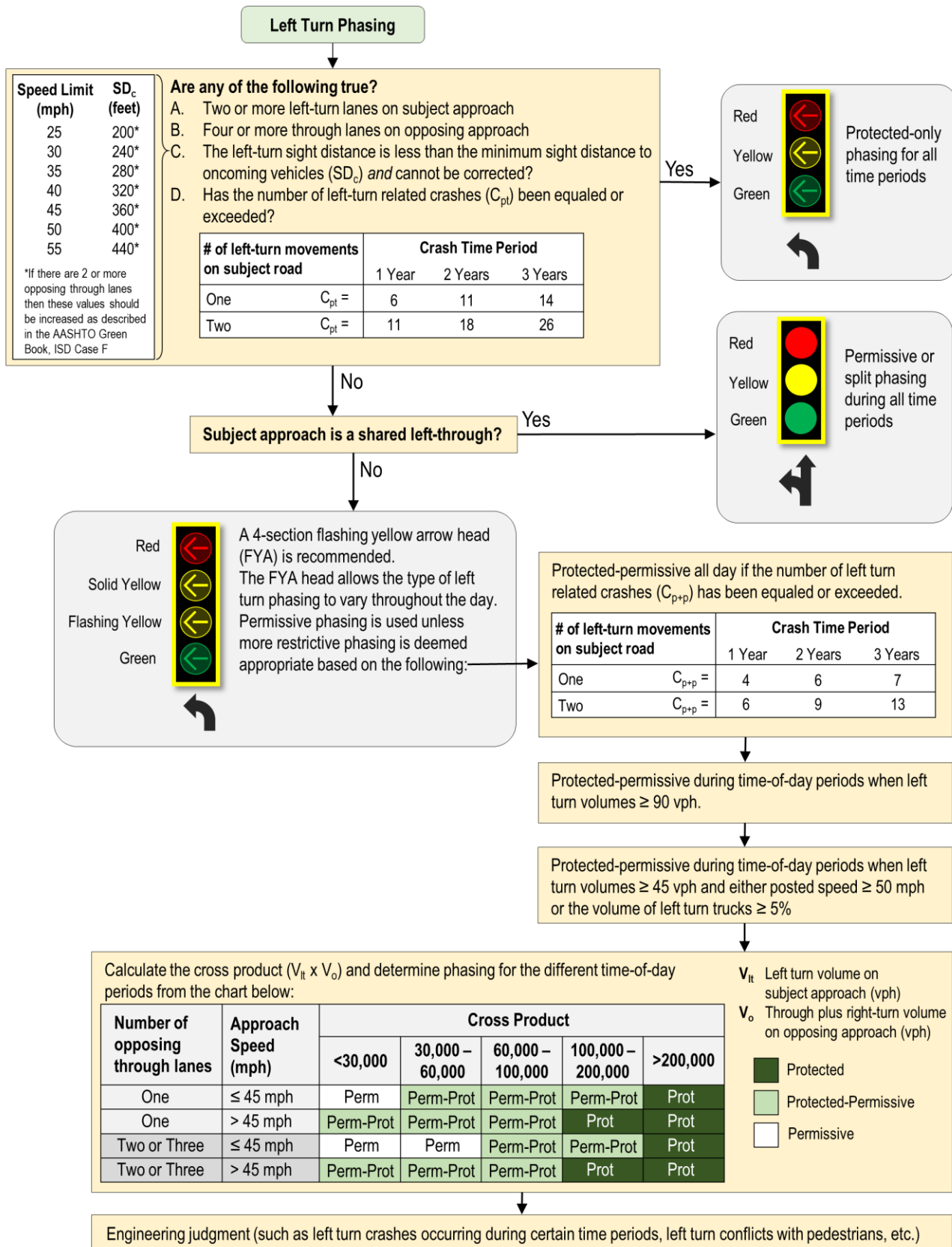

TYPICAL TRAFFIC SIGNAL DETECTION ZONE LAYOUT

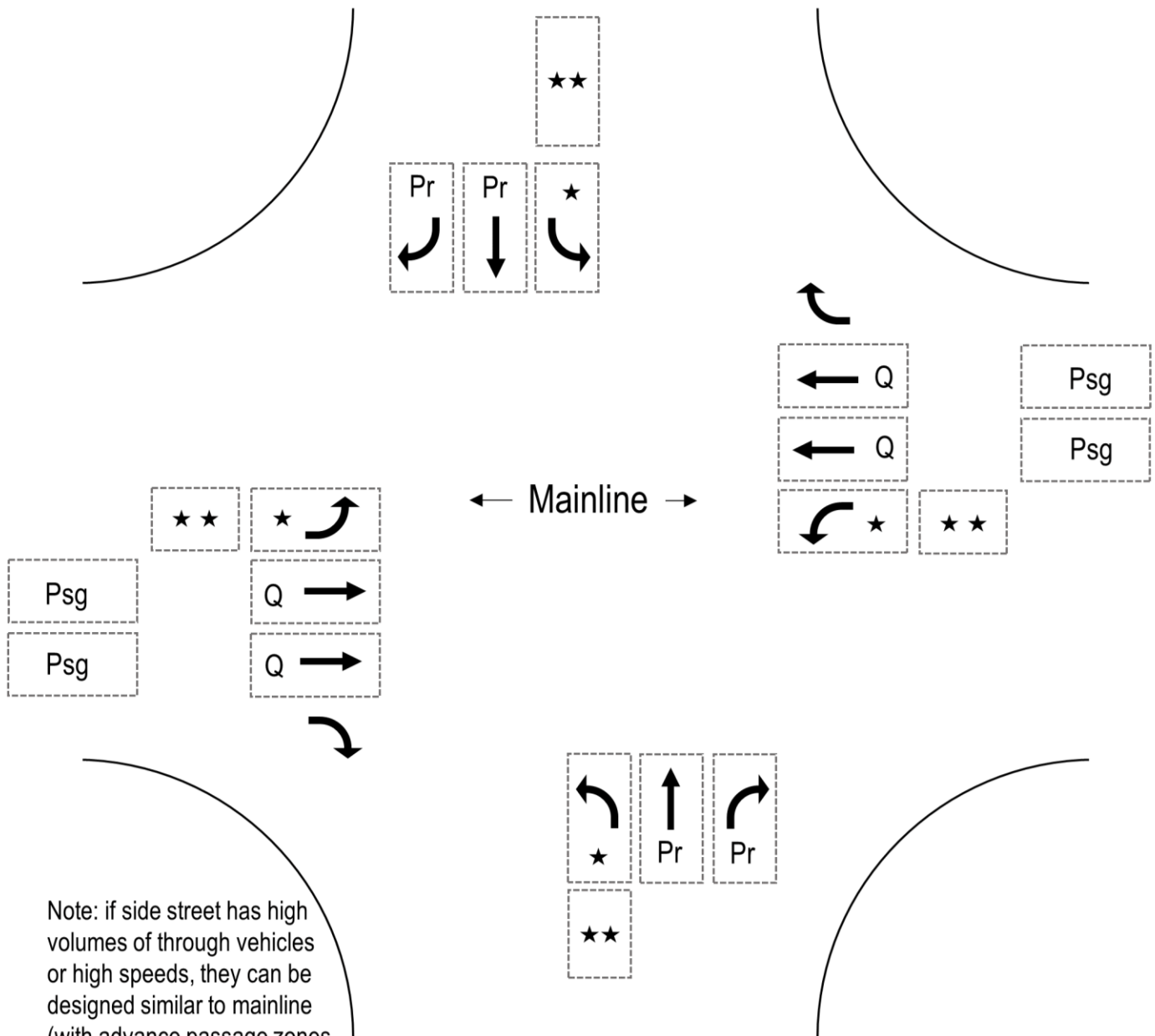

Note: if side street has high volumes of through vehicles or high speeds, they can be designed similar to mainline (with advance passage zones and queue detectors at stop bar).

- ★ Presence zone calls FYA.
- ★★ Presence zone calls protected left turn phase (the green arrow).
- Pr = Presence zone. Side street right turn lanes typically have 8 seconds delay. Mainline right turn lanes typically don't need a detection zone.
- Psg = Passage zone in advance of intersection
- Q = Queue detector. Extends green until there is a gap in traffic and then turns off until the next cycle (approach still runs using the advance passage detectors).

TRAFFIC SIGNAL ADVANCE WARNING BEACONS

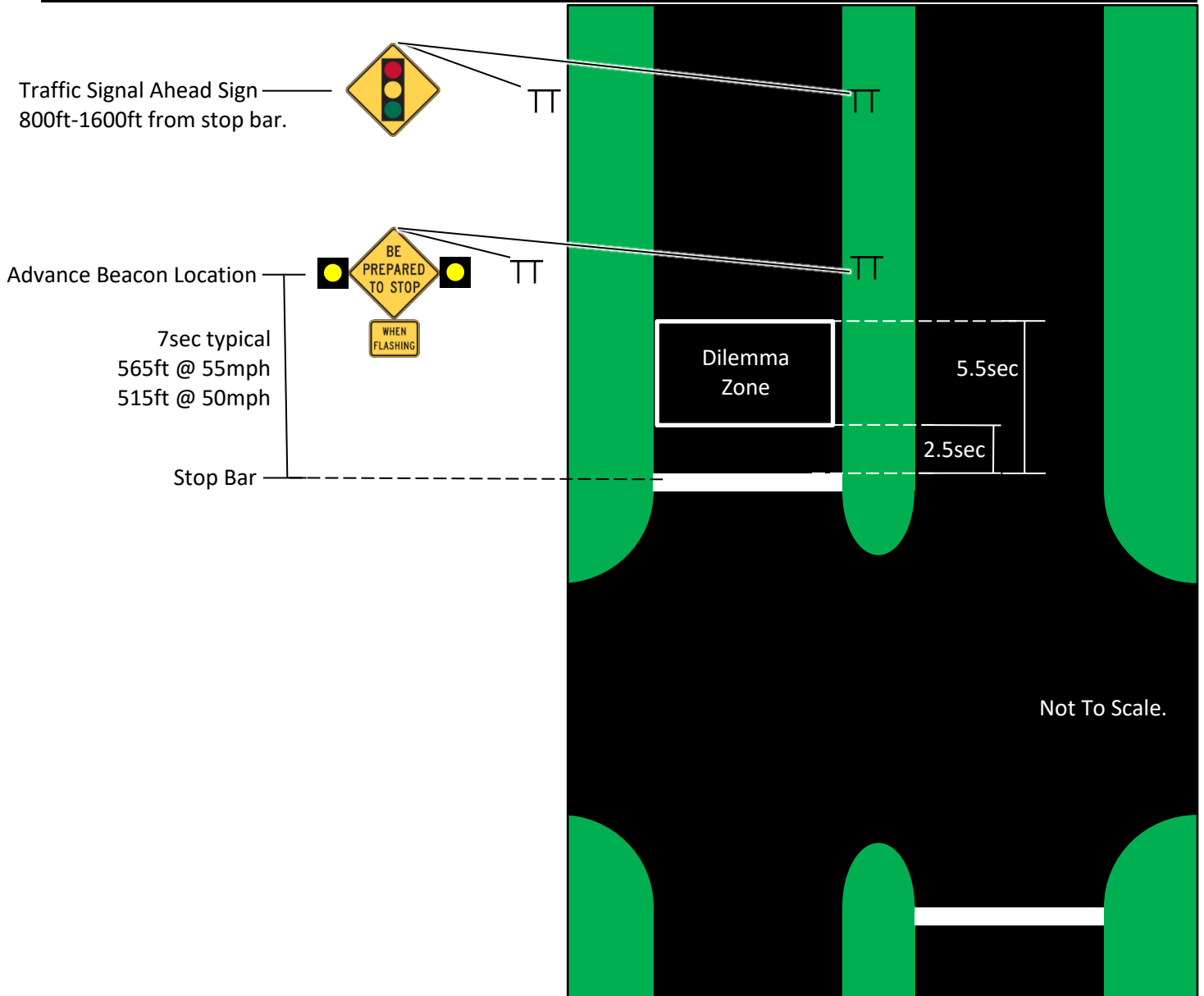

- The beacon flash time shall be the same as the travel time between the advance beacons and the stop bar. For example, 7sec travel time means 7sec of beacon flash time prior to the traffic signal changing from green to yellow.
- If a driveway is in conflict with the advance beacon location, the beacons may be moved farther from the stop bar. However, then the beacon flash time needs to be adjusted (different flash times for different directions of travel, or move the beacons for both directions of travel back to the same distance from the stop bars). If advance beacons are moved farther from the stop bars, then delay will increase for side street traffic.
- The advance beacons shall be located upstream of the dilemma zone. The upstream edge of the dilemma zone is considered to be 5.5 sec from the stop bar¹.
- 55mph = 80.67 ft/sec. 50mph = 73.33 ft/sec.

References:

1. TRB, [“NCHRP Report 812: Signal Timing Manual, 2nd Edition”](#), 2015 (page 4-6)

REMOVAL OF TRAFFIC SIGNAL

A signal warrant analysis should be completed for existing signalized intersections when a traffic operations report is needed for a project or when more than preventive maintenance work is being completed on the signal. The preferred traffic signal removal process should follow the process shown below.

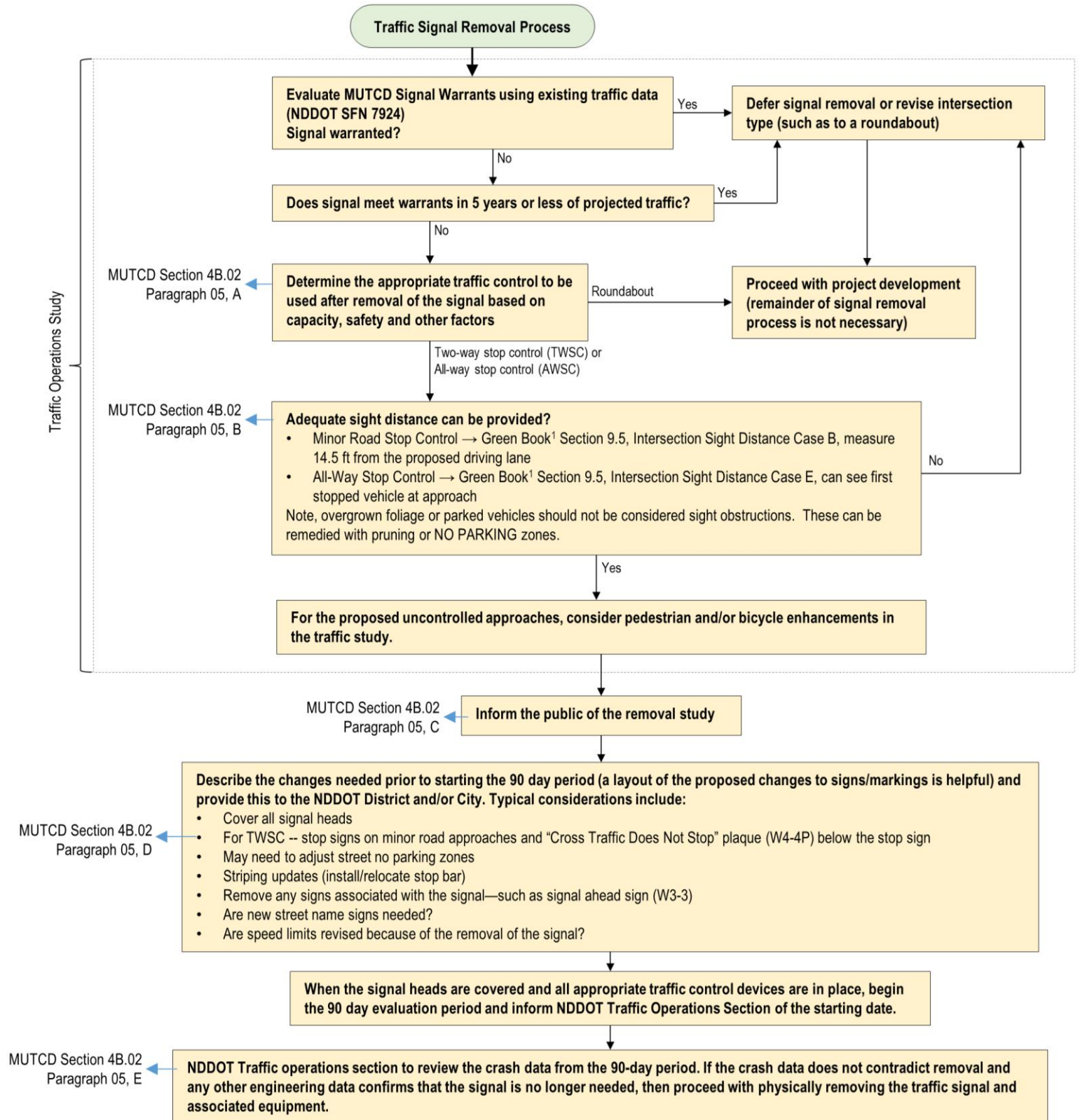

References:

1. AASHTO, "A policy on Geometric Design of Highways and Streets," 7th Edition. 2018.

ACCESS MANAGEMENT

Access management is the coordinated planning, regulation, and design of access between roadways and land development. It deals especially with the location, spacing, design, and operations of interchanges, street connections, median openings, and driveways.¹

Why Is Access Management Needed²

Access management is needed to provide people access to land development in a manner that preserves the safety and efficiency of the transportation system. The following problems are caused when there are too many driveways, intersections, or closely-spaced traffic signals on major roads:

- Crashes increase as vehicles cross and turn along the road in an uncoordinated manner.
- Stop and go conditions frustrate commuters and local residents.
- Adjacent businesses suffer when customers have trouble turning into their sites.
- Freight and delivery trucks lose time and money stuck in traffic.
- Pedestrians can't find a safe spot to cross the road.
- Overall community livability suffers.

FHWA promotes corridor access management as a proven safety countermeasure.³ Also, ND's Vision Zero Plan (a.k.a. Strategic Highway Safety Plan) lists access management as a Priority Safety Strategy.⁴

What Are The Benefits Of Access Management²

- Crashes and congestion are reduced.
- Roadway capacity is preserved, delaying the need for roadway widening.
- Travel times and delivery of goods and services are improved.

When/Where Should Access Management Be Applied

- New roads and new developments
- Roadway reconstruction projects or land redevelopment projects as feasible*
- Other road construction projects on a smaller scale as opportunities arise*

*Retrofit projects in built-up areas may not be able to improve access management to the ideal conditions presented below. However, small improvements that are well thought out and appropriately tailored to an area can still make things better than they are today.

Why Act Now⁵

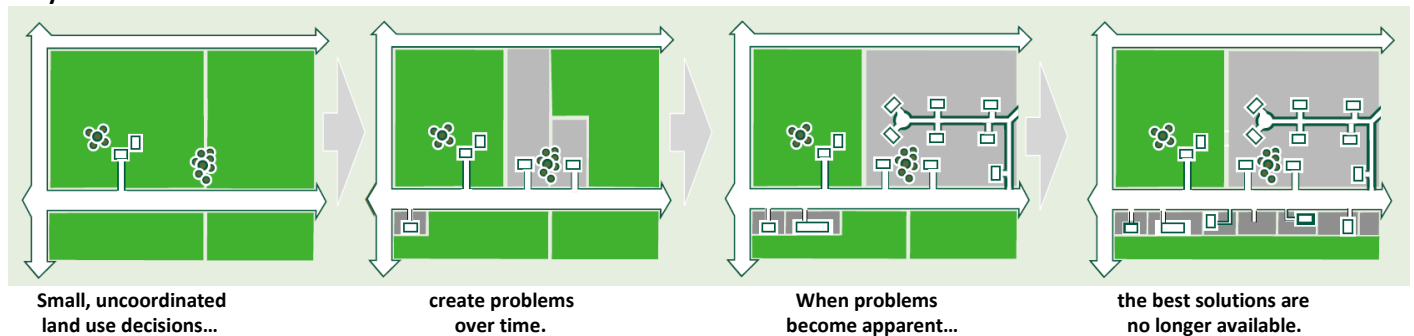

References:

1. TRB, "Access Management Manual Second Edition", Page 3, 2014
2. WisDOT webpage and MnDOT brochure.
3. FHWA, "Proven Safety Countermeasures", 2020
4. NDDOT, "North Dakota Vision Zero Plan", page 5-4, 2018.
5. MnDOT Brochure

ACCESS MANAGEMENT NEAR INTERCHANGES

Optimal Interchange Spacing (Crossroad to Crossroad)

- Urban = 2mi desired to minimize weaving¹, 1mi minimum²
- Rural = 5mi desired³, 2mi minimum⁴

Access Spacing Near Interchanges⁵

- The figure below shows allowable access spacing near interchanges.
- Prohibit full access unsignalized intersections between off-ramps and the closest signalized intersection (or future signalized intersection). Unsignalized accesses in this area shall be either a directional median opening (3/4 access) or a right-in right-out access.

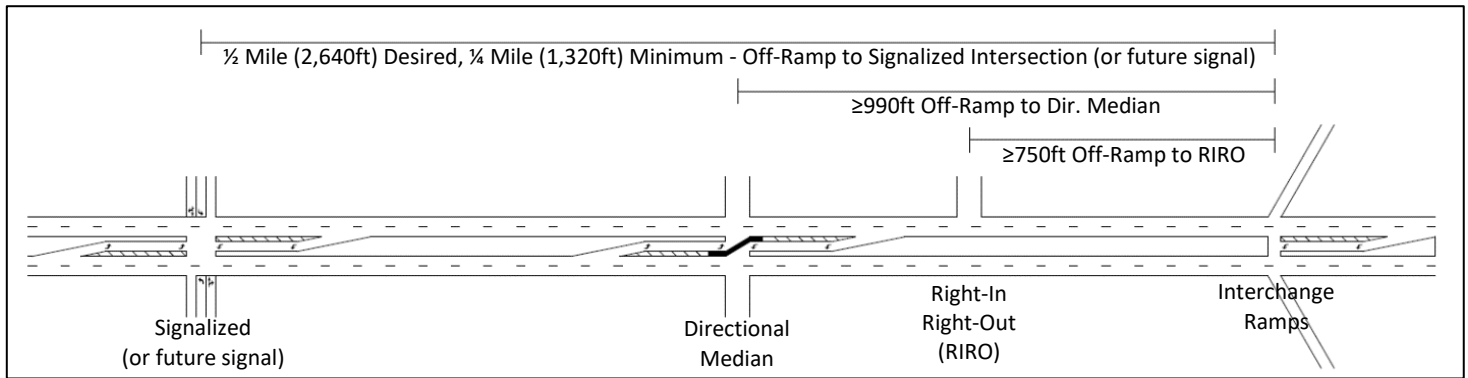

Allowable Access Spacing Near Interchanges

To preserve the functional area of an interchange, roads that are parallel to an interstate may need to curve away from or curve perpendicular to the interstate near an interchange.



Parallel Roads Turn Perpendicular From Interstate



Parallel Roads Curve Farther From Interstate

References:

- Interstate Access Guidance and Analysis training class by Chung Tran (FHWA) at Comfort Inn Hotel in Bismarck, ND on 5/19/2015.
- Green Book page 10-82, section 10.9.5.3
- Freeway and Interchange Geometric Design Guide page 243, published by the Institute of Transportation Engineers (ITE) in 2005.
- Green Book section 10.9.5.3.
- TRB, "Access Management Manual Second Edition", 2014, page 436, Exhibit 18-6

ROADWAY HIERARCHY, NETWORKS, AND TRAFFIC SIGNAL SPACING

Roadway Hierarchy

A viable community requires a variety of roadways organized as an integrated system. Arterials are needed for longer, higher speed trips. Local streets and collectors are needed for access to homes and businesses.

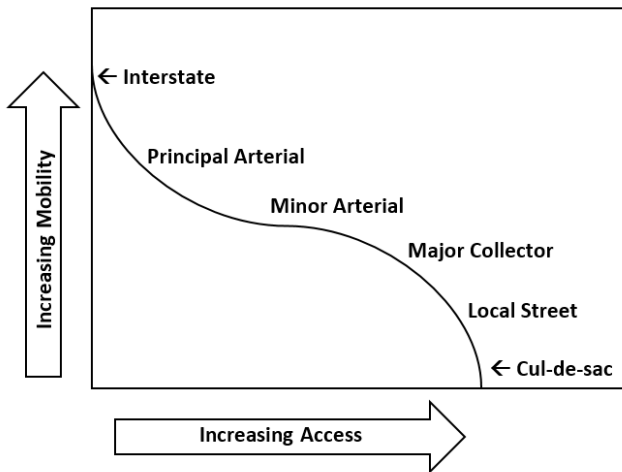

Typical Roadway Classifications (A.M.M.¹,p 67)

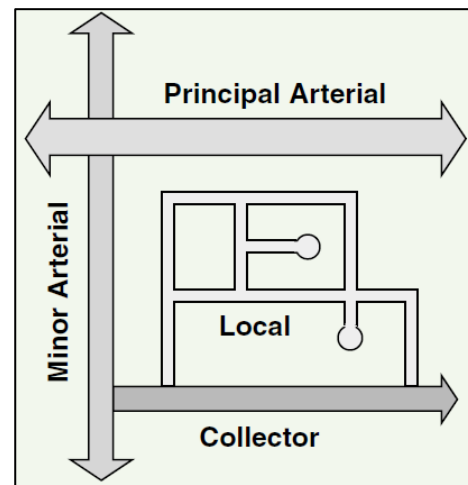

Integrated Network of Roads²

Roads should intersect similarly classified roads or roads with a functional class only one step above or below themselves (A.M.M.¹,p 69). For example, driveways should not directly access principal arterials. One exception is that driveways can intersect minor arterials or major collectors, skipping the connection to a local street.

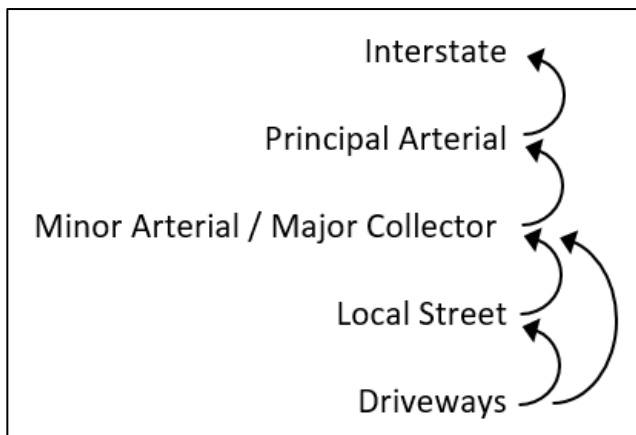

Access Relationship b/w Functional Classes (A.M.M.¹,p 69)

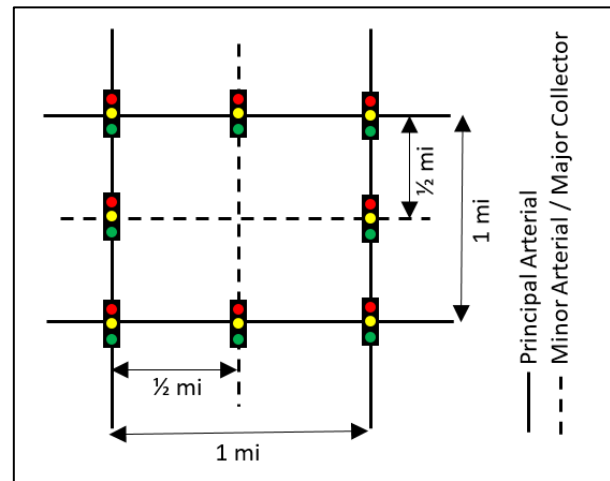

Urban Arterial Spacing Guidelines (A.M.M.¹,p 77)

Roadway Networks

- Provide a principal arterial every 1 mile, with minor arterials or major collectors approximately halfway between principal arterials (A.M.M.¹,p 77).
- It is desired to have roadway networks rather than 1 main road through town. Networks allow for alternate routes and spreading out of traffic, rather than funneling of traffic. With networks less mainline thru lanes are needed, which reduces costs and shortens pedestrian crossing distances.
- Avoid strip developments (many lots with direct access to an arterial). Commercial development can be located adjacent to and visible from main roads but should be accessed via a system of parallel local roads and side streets (A.M.M.¹,p 408). See figures on the next page.

References:

1. TRB, "Access Management Manual Second Edition", 2014
2. MnDOT brochure.



Strip Development (many lots with direct access to the arterial), ***DON'T DO THIS***



Development with Reverse Frontage and Limited Access onto the Principal Arterial, ***DO THIS***

Optimal Traffic Signal Spacing (A.M.M.¹, p 356, 357).

- On principal arterials ½mi signal spacing is desired, ¼mi spacing minimum. ½mi spacing accommodates good two-way traffic progression for a variety of signal timings.
- A four-lane divided arterial with ½mi signal spacing and a high level of access control has the same ability to carry traffic as six lanes with ¼mi signal spacing and a low level of access control.
- In central business districts with a 25mph posted speed, a signal spacing of 3 blocks is able to accommodate good two-way traffic progression.

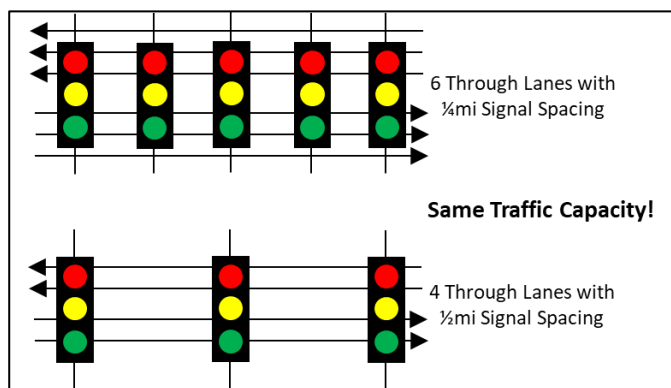

Traffic Capacity is Better with Longer Signal Spacing

References:

1. TRB, "Access Management Manual Second Edition", 2014

TWLTL AND RAISED CENTER MEDIANS

Two-Way Left Turn Lanes (TWLTL) (A.M.M.¹, p 410, 480).

- Can be used where future mainline AADT < 24,000 and the adjacent property has limited frontage and low trip generation.
- Can be retrofitted onto an existing 2-lane or 4-lane road by performing a “road diet”.
- Are safer and have increased capacity compared to an undivided roadway. Two ways that roads are safer with a TWLTL: 1) when waiting to make a left turn, drivers are able to stop outside of the through lane and not block through traffic, 2) when opposing left turners stop at the same time they don’t block each other’s vision of through traffic.
- Do not provide a refuge for pedestrians and can increase their crossing distances/exposure time.
- Can promote strip development and too many driveways accessing a roadway.
- Are less safe than a divided roadway with a raised center median.



Two-Way Left Turn Lane (TWLTL)



Raised Center Median

When To Use A Raised Center Median (A.M.M.¹, p 411)

- Three or more mainline through lanes in one direction.
- Mainline AADT ≥ 24,000.
- New urban multilane arterials.
- Bypasses of urban areas.
- Between closely spaced roundabouts.

Additional Considerations When Using A Raised Center Median

- Ensure the median is wide enough to provide zero offset or positive offset left turn lanes, rather than negative offset left turn lanes. Zero offset or positive offset left turn lanes will provide adequate intersection sight distance, Case F.²
- Use of full access unsignalized intersections is discouraged where there are 3+ mainline through lanes in one direction or when the mainline AADT ≥ 24,000. In these situations there are few gaps for side street vehicles. Rather than full access, directional median openings (3/4 access) or right-in right-out accesses should be used. Accommodating U-Turns at nearby signalized intersections or nearby roundabouts may be appropriate (A.M.M.¹, p 418).

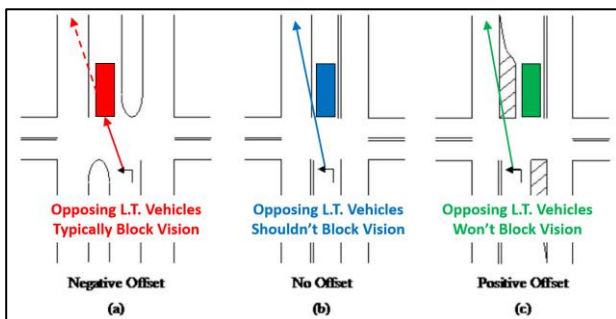

Left Turn Driver’s Vision for Various Offsets

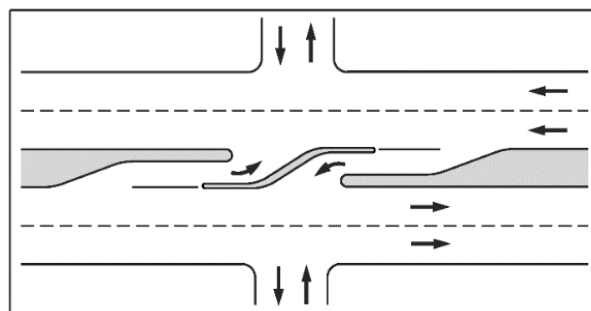

Directional Median Opening

References:

1. TRB, “Access Management Manual Second Edition”, 2014
2. Green Book page 9-56, section 9.5.3.6

FUNCTIONAL AREA, FRONTAGE ROADS, AND DRIVEWAYS

Intersection Functional Area (A.M.M.¹,p 332, 341, 379).

- The functional area of an intersection is larger than the physical area of an intersection.
- The functional area upstream of an intersection consists of three distances added together:
 - *Distance traveled during a driver’s perception-reaction time,
 - *Distance traveled when decelerating to a stop, and
 - *Vehicle queue storage distance.
- The functional area downstream of an intersection consists of enough distance for drivers to accelerate back up to speed if they were previously stopped and should be at least as long as the stopping sight distance for the roadway.
- Accesses should not be allowed within the functional area of an intersection. However, many intersections already have existing accesses within the functional area. If it is not feasible to remove existing accesses, consideration should be given to relocating them as far as practical away from the intersection or restricting them to right-in right-out.

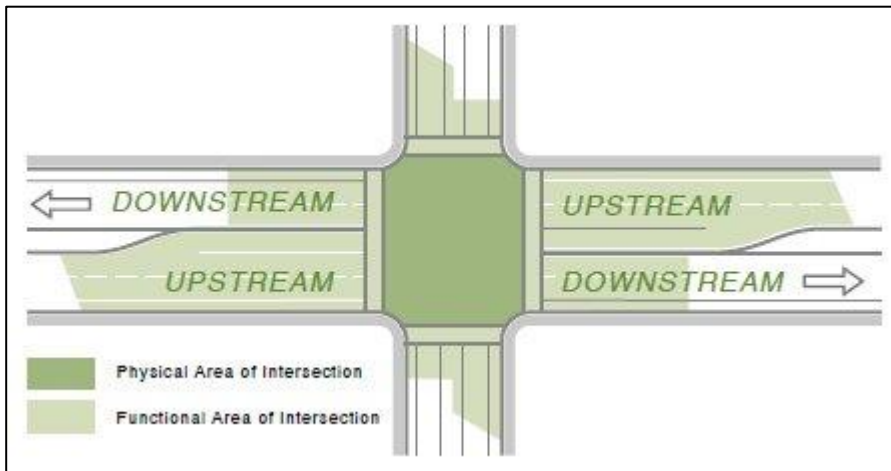

Functional Area of an Intersection²

Frontage Roads (A.M.M.¹,p 190, 502).

- Frontage roads consolidate the number of access points and tend to work well where traffic volumes are fairly low, such as: rural areas, urban light office developments, and urban single-family residential developments.
- Figure 17 shows the desired separation between the major road and a frontage road.

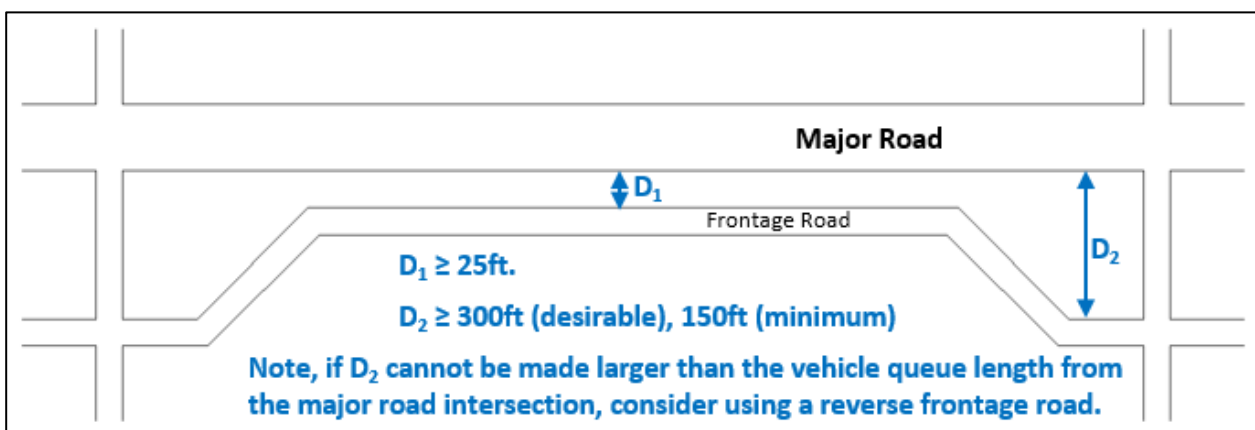

Figure 17 – Minimum Separations for Frontage Roads (A.M.M.¹,p 190, 502)

References:

1. TRB, “Access Management Manual Second Edition”, 2014
2. FHWA, “Access Management in the Vicinity of Intersections, FHWA-SA-10-022”, p2, figure 1, 2010

Reverse Frontage Roads

- Reverse frontage roads have buildings between the major road and the reverse frontage road
- Reverse frontage roads should be used where:
 - *the queue length from the main intersection would backup through a regular frontage road,
 - *there are higher traffic volumes,
 - *the volume of trucks is significant, or
 - *there is a large commercial development or clusters of commercial properties
- The separation between the main intersection and the reverse frontage road should fit the left turn lanes and taper shown below.

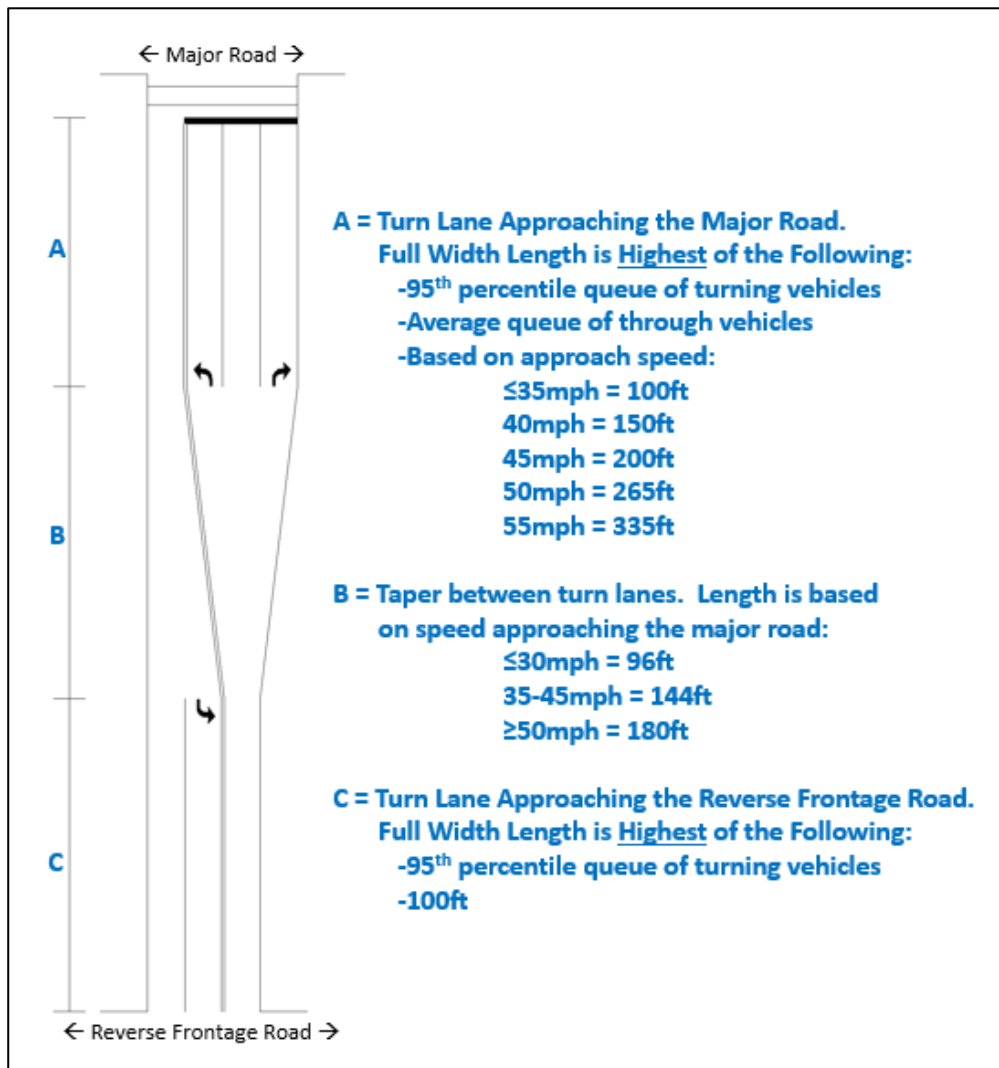

Turn Lane Lengths Between Major Road and Reverse Frontage Road¹

References:

1. NDDOT, ["Design Manual"](#). August 2013. (Section III-03.05.01)

Driveways

- Driveways should be located outside of intersection functional areas and should be located so that left turn path conflicts are avoided (A.M.M.¹, p 332).
- As stated previously in the Road Hierarchy section, driveways should not directly intersect principal arterials. However, where existing driveways already intersect arterials it may not be feasible to eliminate all the driveways. Consolidating driveways, such as providing one shared driveway between neighboring properties, is one technique that can still be applied to reduce the number of driveways (Figure 20). Some benefits of reducing the number of driveways are that the number of conflict points with the main road are also reduced, left turn path conflicts can be eliminated, and the number of parking spots available in parking lots can be increased (A.M.M.¹, p 341).
- For corner properties, access should be provided on the lower volume street rather than the higher volume street.²
- Unified access and circulation systems should be provided for large commercial developments and for clusters of commercial properties (A.M.M.¹, p 18).
- Table 1 lists the desired spacing between unsignalized accesses on the same side of a road (A.M.M.¹, p 365).

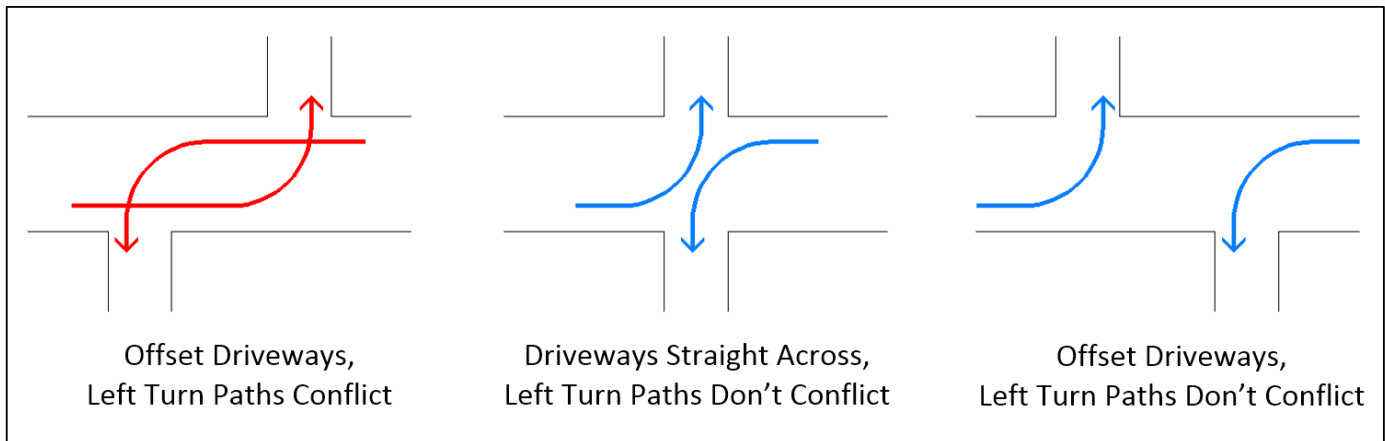

Driveway Layouts and Left Turn Paths (A.M.M.¹, p 343-346)

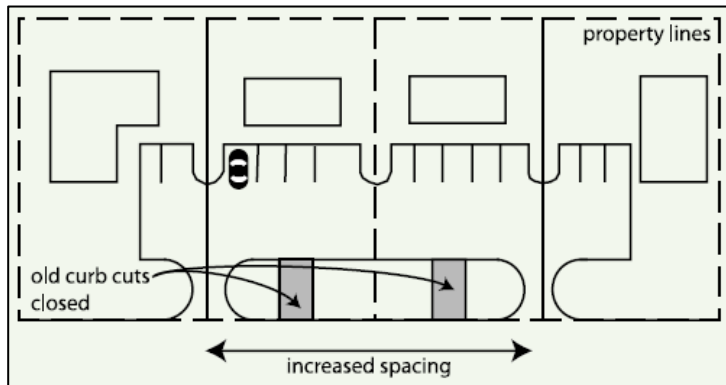

Figure 20 – Example of Driveway Consolidation³

Table 1 - Spacing of Unsignalized Accesses on the Same Side of a Road	
Major Road Posted Speed (mph)	Desired Spacing of Unsignalized Accesses (ft)
25	325
30	455
35	625
40	820
45	1,045
50	1,325
55	1,655
60	2,060
65	2,625
70	3,315

References:

1. TRB, "Access Management Manual Second Edition", p 332, 2014
2. FHWA, "Access Management in the Vicinity of Intersections, FHWA-SA-10-022", page 2, section 1.1, page 4, section 1.3, 2010
3. MnDOT Brochure.