

## Chapter III – Roadway Design

### Table of Contents

[Section 1: Plan Preparation](#)

[Section 2: Design Checklist](#)

[Section 3: Alignment and Roadway Geometry](#)

[Section 4: Earthwork](#)

[Section 5: Bases, Edge Drains, and Prime](#)

[Section 6: Surfacing](#)

[Section 7: Pedestrian and Bicycle Facilities](#)

[Section 8: Utility Relocation, Adjustments, and Accommodation Policies](#)

[Section 9: Permanent Signing](#)

[Section 9: Appendix A: Permanent Signing Details](#)

[Section 9: Appendix B: NDDOT Interchange Numbering on I-94](#)

[Section 9: Appendix C: NDDOT Interchange Numbering on I-29](#)

[Section 9: Appendix D: Sign Support Design](#)

[Section 10: Marking](#)

[Section 10: Appendix A: Pavement Marking Material Selection](#)

[Section 10: Appendix B: Left Turn, Stop Bar, Crosswalks, and Bicycle Lanes](#)

[Section 10: Appendix C: Bicycle Lanes Details](#)

[Section 11: Lighting](#)

[Section 12: Traffic Control Signals](#)

[Section 13: Guardrail](#)

[Section 13: Appendix A: Various Guardrail Layouts and Details](#)

[Section 13: Appendix B: Guardrail Length of Need Details](#)

[Section 14: Safety Reviews](#)

[Section 14: Appendix A: Figures](#)

[Section 14: Appendix B: Clear Zones, Horizontal Curve Adj.](#)

[Section 15: Fills \(Over 7'\), Foreslope Flattening, and Flattening at Culverts](#)

[Section 16: Driveways and Access Management](#)

[Section 17: Airport Clearances](#)

[Section 18: Work Zone Traffic Control](#)

[Section 18: Appendix A: Maintaining Traffic \(Temp Bypass, Detour, & One Lane Closure\)](#)

[Section 19: Landscaping/Billboards](#)

### III-01.01 Reports and Resources

The designer should consult the following reports and resources as appropriate:

- **Traffic Data.** From the Planning/Asset Management Division. Information requested from this section includes average daily traffic and ESALs (Equivalent Single Axle Loads).
- **Pavement Condition.** The pavement distress and profile report, and maintenance management system project data are available from the Planning/Asset Management Division.
- **Old Plans for the Project Area.** Located in the records center are copies of completed projects which show what was constructed. These are used to become familiar with what is in place and what improvements will be necessary to bring the new project up to present standards.

Also, the Surveys and Photogrammetry Section in the Design Division has a Survey folder for all proposed regrading projects on the R: drive. This folder contains the following information:

- Existing grading plans
- Railroad plats
- Public land records
- Triangulation Station data
- Bench Mark data
- City Plats
- Utility Plats

- **Linear Soils Survey Report and Pavement Design Recommendations.** These reports are furnished by the Materials and Research Division which provide soils recommendations, pavement recommendations (thickness of base and surfacing, class of aggregate, percent asphalt, etc.) and pavement design life. The pavement design life should be included in the design data information on the plan title sheet.
- **Wetland Delineation Report.** The wetland delineation report indicates impacts to any wetlands on the project, and what mitigation must be provided, if necessary. This is provided by the Engineering and Environmental Section in the Design Division. The consultant may provide this data on the projects they are designing.
- **Cultural Resources Report.** The Cultural Resources Report is provided by the Cultural Resource Section of the Design Division. The consultant may provide this report on projects they are designing.
- **Traffic Operations Report.** This report is provided by the Traffic Operations Section of the Programming Division and provides recommendations with respect to lighting, traffic signals, turning lanes, etc.
- **Survey Data.** After a survey is completed, the project survey data is transmitted to the Records Center by the Surveys & Photogrammetry Section of the Design Division.

- **Safety Review.** Completed by the Traffic Section in the Design Division. For proposed safety improvements, see Section III-14.
- **Right of Way Plats.** Located in the Surveys & Photogrammetry Section in Design Division. For in house projects, the existing ROW plats can also be found in the GIS folder of the NDDOT intranet homepage at <http://mydot.nd.gov/>.
- **Existing Pavement Structure.** Located on Main Frame or printed in the District Highway Information Booklets.
- **Existing Interstate Grading or Paving Plans.** Located in the Records Center in the basement of the Central Office. \*\*
- **Existing Non-Interstate Paving Plans.** \*\*  
Plans are located in the Records Center in the basement of the Central Office.
- **Existing Non-Interstate Grading Plans.** \*\*  
Plans are located in the Records Center in the basement of the Central Office.
- **Existing Bridge Information.** Located in the Structure Inventory Abbreviated Master Listing (Bridge Book) or the Structure Inventory & Appraisal (SIA) Sheets in the Bridge Division.
- **Existing Bridge Plans.** Plans are located in Bridge Division's plan files and in the Records Center in the basement of the Central Office.
- **Existing Aerial Photos.** Located in the Aerial Photography Inventory – Photo Lab in the Survey and Photogrammetry Section of Design Division.

\*\* If unable to find at these locations, check with the respective District.

### III-01.02 Coordination During Plan Preparation Process

Generally, the following items need to be coordinated by the designer during the preparation of the plans.

#### III-01.02.01 Environmental

The designer needs to coordinate with the Engineering and Environmental Section (EES) to obtain the clearances if there is a 4(f) or 6(f) property on the project. See Sections II-05.05.02, II-05.05.03, and II-05.05.04.

If any wetlands are filled or otherwise altered, the designer needs to coordinate with the EES to obtain a 404 permit. See Section II-05.05.06.

If fill is placed in a floodplain, the designer needs to coordinate obtaining a Floodplain Permit. See Section II-05.05.07. If Floodway Authorization is needed, it will be stated in the Solicitation of Views letter from the North Dakota State Water Commission.

If a project lies partially or wholly below the ordinary high water mark of a navigable stream or waterway, the designer needs to coordinate with the EES to obtain a Sovereign Lands Permit. See Section II-05.05.08.

If any work is performed on any bridge, dam, dike, or causeway over or in any port, roadstead, haven, harbor, canal, navigable river, or other navigable water of the United States, the designer needs to coordinate with the EES to obtain a Coast Guard Permit. See Section II-05.05.09.

### **III-01.02.02 Bridge**

The designer needs to coordinate with the Bridge Division if there are bridges and/or box culverts on the project, and what, if any, improvements will be made to them.

### **III-01.02.03 Right of Way**

Generally in the design of a highway project there is a need for right of way of some type. This could also be true for a project designed in the district. The designer or the Environmental Document author should notify the Right of Way Section in the Design Division, by the milestone date or as soon as it is available, of the right of way (R/W) needs for the respective project. Typically this would include but would not be limited to the following:

- Permanent R/W
- Temporary construction easement
- Borrow quantity needed
- Drainage easement
- Relocation assistance if the taking involves an occupied dwelling, business, farm operator or non-profit organization.
- Waste site to dispose of excess material
- Maintenance storage site
- Stockpile site
- Building site
- Request estimate of R/W cost.
- Check if R/W representative needs to go on the field review.

#### **III-01.02.03.01 Right of Way Width For Urban Projects**

New construction or major reconstruction on urban or urban extension systems or in cities with less than 50,000 population will normally require that adequate R/W is provided for street hardware, sidewalk and possibly a narrow boulevard. To provide this space will generally require 8 feet from the face of the proposed curb to the R/W. This should be done according to the following procedure:

- The Environmental Document should address the R/W needs from the curb to the R/W line. It should also address any general exceptions to the border width when the dimension is less than 8 feet from face of curb to the R/W line.
- Existing widths less than 8 feet which are not disturbed generally will be allowed to remain if there are no identifiable problems.



- In cases where the border width is reduced to less than 8 feet, the Design Engineer, Programming Engineer, District Engineers and the representative of the local agency should review the situation and recommend acquiring additional R/W or requesting an exception to the 8 foot width.
- The 8 foot width may be reduced at certain locations such as right turn lanes. The area must still safely provide space for sidewalk and street hardware (lighting, signing, etc.).
- Approval of the Environmental Document by the Deputy Director for Engineering and FHWA, where appropriate, will constitute approval for all location exceptions identified in the report. Any deviations to the 8 foot width during design or construction should be coordinated with the Design Engineer.

#### **III-01.02.04 Traffic Control and Guardrail**

Generally, the project will involve traffic control items such as signing, pavement marking, traffic signals, and lighting. Guardrail may also be required. These items should be coordinated with the Traffic Section in the Design Division.

#### **III-01.02.05 Utilities**

Generally, there are utilities (gas, electric, water, sewer, telephone, etc.) on every project. In many cases they may be in the way of the proposed improvement. The designer needs to coordinate this with the Utilities Engineer in the Technical Support Section of the Design Division to determine the course of action to take. If the utilities have to be relocated or adjusted, the Utilities Engineer will coordinate this with the respective utility. For consulting engineers, see section III-08.04.

#### **III-01.02.06 Airport Clearance**

Whenever the project is near an airport, the designer needs to coordinate this with the Utilities Engineer in the Technical Support Section of the Design Division, who in turn will work with the Federal Aviation Administration to obtain an Airport Clearance. See Section III-17.

#### **III-01.02.07 Special Provisions**

There are times when the Standard Specifications don't cover the items to be incorporated into the project. When this occurs and a plan note will not suitably describe the requirements, the designer needs to coordinate with the Engineering Services Section of the Maintenance and Engineering Services Division to have a Special Provision written. See Section III-20.

**III-01.02.08 Agreements (Preliminary Engineering, Cost Participation and Maintenance)**

When a project involves an urban area, generally the local municipality must participate in the cost of preliminary and construction engineering and do maintenance. The Local Government Division will develop this agreement for cities with a population greater than 5,000. The designer for internally developed projects or the Technical Support Contact for consultant projects needs to coordinate with the Local Government Division and provide needed information.

For a city with a population under 5,000 the Programming Division will develop the agreement. The designer for internally developed projects or the Technical Support Contact for consultant projects needs to coordinate with the Programming Division and provide needed information.

**III-01.02.09 Railroad Agreements**

When the improvements on a project will take place on railroad right of way, the designer needs to coordinate with the Right of Way Section of the Design Division to obtain the necessary document permitting the Contractor to operate on Railroad right of way.

If the proposed work involves a railroad bridge, the designer needs to coordinate with the Bridge Division.

**III-01.03 Mobilization**

All plans should include a bid item for mobilization.

**III-01.04 Plan Review Checklists**

Plan review checklists are located in Appendix III-01 A through III-01C and can be found at <http://www.dot.nd.gov/designmanual.html> under Reference and Forms or under the pull down menu for Chapter 3 Section 1.

## Detailed Plan Design and Development Checklists

The following checklists are provided:

- Plan Design and Development Checklist - General
- Plan Design and Development Checklist - Traffic Control Design (Signing, Pavement Marking, Guardrail, Lighting, Traffic Signals)

**PLAN DESIGN AND DEVELOPMENT CHECKLIST - GENERAL**

1. Review Reports and Resources
  - A. Review environmental document, summation and transcript of public hearing documents, and/or environmental documents (plan sheets should incorporate all necessary mitigation measures identified)
  - B. Review traffic operations report
  - C. Review surface thickness and material recommendations
  - D. Review linear soil survey recommendations
  - E. Review drainage report
  - F. Review 90-1 survey and safety review
  - G. Gather and review old plans for the proposed project area
  - H. Obtain and review survey data
  - I. Review milestone for critical activity dates
  - J. Schedule preliminary review, PS&E review, and plan completions dates
2. Coordination
  - A. Advise other sections, divisions, districts, city, and/or FHWA of changes made in alignment, drive locations, grades, etc.
  - B. Review environmental considerations with ETS Division – Environmental Services
    1. Army Corp of Engineers Section 404 Permit
      - a. Wetland mitigation
      - b. Large stream crossings
    2. Review need for erosion control and develop erosion control plan
    3. Satisfy flood plain requirements
  - C. Review coordination of signing, marking, signals, lighting, and guardrail with Design Division – Traffic Section
  - D. Review coordination of private utility relocations and adjustments with Design Division – Technical Support Section, Utility Engineer
    1. Submit preliminary plan and profile sheets and cross section sheets

- E. Review coordination of airport clearance with Design Division – Technical Support Section, Utility Engineer
- F. Review coordination of right of way, easements, encroachments, etc., with ETS Division – Right of Way Services.
- G. Review coordination of bridges and box culverts with Bridge Division
- H. Review coordination of special provisions (SP) with ETS Division – Technical Services.
  - 1. Review need of common special provisions:  
<http://www.ugpti.org/dotsc/prepguide/index.php>
  - 2. Submit required special provisions to ETS Division – Technical Services a minimum of 4 weeks prior to the PS&E
  - 3. Submit required TERO special provisions to ETS Division – Technical Services a minimum of 8 weeks prior to the PS&E
  - 4. SPs to be listed on Basis of Estimate of plans (include SPs from other sections and divisions)
- I. Review coordination of bench sections and stabilized earth retaining walls with Materials and Research Division
- J. Review coordination of Preliminary Engineering and Cost Maintenance Agreements with the Programming Division or Local Government Division
- K. Review coordination of railroad crossings with Planning/Asset Management Division – Railroad Section
  - 1. Submit preliminary plan and profile sheets and cross section sheets
  - 2. Determine if any crossings are to be abandoned or if the number of tracks be reduced
  - 3. Determine type of crossing: rubber, wood, or asphalt cement (check with city or district)
  - 4. Determine type of traffic control: signalized, not signalized
  - 5. Determine clearances
  - 6. Determine need for pipe crossings, jacked or bored (need standard drawing and railroad request forms for permit)
  - 7. Include standard drawings for railroad approach and pavement markings

8. Include appropriate standard note(s) 107-111 to 107-115 (depending on Railroad Company) and pay item to require liability insurance
9. Check for correct railroad names
- L. City utilities or city projects (participating funds or city funds only)
  1. NDDOT to complete design
  2. City to complete design
  3. Include in NDDOT plan sheets, separate plan sheets, tied or not-tied contracts
  4. Review need for city specifications
  5. Review bid items, existing, new, and coordination of similar items
  6. Obtain utility certification or disposition of relocations and adjustments
- M. Maintain project files (document meetings, telephone calls, decisions, etc)
3. General Plan Development
  - A. Develop Geometric Design
    1. Horizontal alignments (tangents, curves, spirals, superelevation)
      - a. Check design vehicle
      - b. Check truck turning radii
    2. Vertical alignments (grades, crest and sag curves, sight distances, passing zones)
      - a. Develop profile grades and PIs (vertical curve lengths calculated from design speed)
      - b. Check grade line and topography for hidden intersections or decision sight distance locations
      - c. Check grades to fit approaches, driveways, side streets, etc.
      - d. Check vertical clearance at bridges
      - e. Check grades to fit right of way constraints
  3. Roadway cross section
    - a. Review recommended base and pavement structure
    - b. Determine profile grade point and cross slopes

- c. Determine lane and shoulder widths
- d. Determine foreslopes
- e. Determine ditch sections and profiles
- f. Determine cut and fill slopes and bench sections (bench sections should be reviewed with Materials and Research)
- g. Determine backslopes

**B. Develop Intersection Design**

- 1. Develop intersection layout and/or type (Standard Drawing D 203 6, Type A and B, Radial “T”, etc.)
  - a. Determine design vehicle and check turning radii
  - b. Determine channelization/median requirements
  - c. Check lane alignments and skew across intersection
  - d. Check sight distances
  - e. Check need for traffic islands
  - f. Check need for left turn lanes
  - g. Check need for right turn lanes
  - h. Check requirements for tapers and storage lengths
  - i. Review location for crosswalks and curb ramps
  - j. Review signal locations
  - k. Review need for parking restrictions

**C. Develop Earthwork Design**

- 1. Determine clearing and grubbing
- 2. Determine removal of structures
- 3. Determine classification of excavation
- 4. Determine subcuts
- 5. Review borrow

- a. Determine borrow or waste requirements
  - b. Determine mandatory borrow or mandatory waste requirements
    - (i) Obtain public interest determination from FHWA for mandatory borrow and excavation sites
  - c. Submit requirements to ETS Division – Right of Way Services
6. Determine need for slope flattening
  7. Determine shrink and swell factors
  8. Balance earthwork and/or determine borrow needs
  9. Compute haul
  10. Develop mass diagrams
  11. Review need of erosion control and protection
- D. Develop Drainage Design
1. Determine drainage areas, size pipe, and compute quantities for:
    - a. Culverts (centerline and approaches)
    - b. Storm drains (pipe, inlets, manholes, castings, etc)
    - c. Lift stations
- E. Develop Right of Way Design
1. Existing permanent right of way
  2. New permanent right of way
  3. Temporary construction easements
  4. Temporary and permanent drainage easements
  5. Access control requirements
  6. Intersection sight distance requirements



- F. Prepare preliminary and final cost estimates
  - 1. Traffic Section quantities included
  - 2. Right of Way Services Section costs included
  - 3. Bridge Division quantities included
  - 4. Materials and Research Division quantities included
- 4. Plan Sheet Development
  - A. **Section 001 - Title Sheet**
    - Project numbers (main funding number and secondary funding numbers)
    - PCN number
    - Design data (current and forecast traffic, HS bridge live load, pavement design life, etc.)
    - Project description (county, project number, location, type of work)
    - Governing specifications paragraph
    - Length of project (gross and net miles)
    - North arrow
    - Legal Description (section, township, range)
    - Project data/map (begin and end limits, reference points, stations, equations, bridges, exceptions, county lines, interchanges, and highways)
    - Plan completion date and signature block
    - Mile splits
    - Clearzone distance
    - Barrier striping diagram and legend
    - Borrow sites and stockpile sites (may show as separate detail sheet)
  - B. **Section 002 - Table of Contents Sheet**
    - Section Number, Sheet numbers, and Description
    - Sheet numbers included for each contract on multiple contract projects
    - List of Standard Drawings (do not number sheets)
  - C. **Section 004 - Scope of Work Sheet**
    - Detail showing layout and type of work
    - PE Signature Block
  - D. **Section 006 - Notes Sheets**
    - Review list of standard notes and write any additional plan notes
    - Check that all incidental items are included in the notes
    - Check that all pay items listed in notes are included on the quantity sheets
    - PE Signature Block

**E. Section 008 - Quantities Sheets**

- Check that the Item Description is exactly as it is written in the Mainframe or Annual Average Bid Price.
- Check that totals match plan sheet totals
- Check that subtotal match totals
- Show funding splits (participating, non participating, city funds only, alternatives, total)
- Check to include all quantities from other sections and divisions
- Check to include all quantities listed in plan notes and special provisions
- Contract bond, mobilization, railroad insurance, field lab (for tied projects show on the major project only)

**F. Section 010 - Basis of Estimate Sheets**

- Pavement Removal pay items
- Grading pay items:
  - Summary of quantity breakdown (excavation, embankment, etc.)
  - Water quantity for embankment, excavation, aggregate, and dust palliative
  - Topsoil removal (list depth and areas)
  - Additional Sheets
  - Base pay items
- Surfacing pay items
- Pavement marking pay items
- Erosion control pay items:
  - Sodding (list areas)
  - Seeding and temporary cover crop (list areas)
  - Mulching (list areas)
  - Erosion control devices
- List core locations and surfacing thickness data (blended base projects)
- List special provisions (number and description)
- PE Signature Block

**G. Section 011 - Data Tables, Concrete Pavement Repair Locations, Coring Data, Salvaged Base Summary, Earthwork Summary, Mass Diagram, Borrow Areas, Alternative Pipe Materials Pipe List Table**

- Crown rates and superelevation tables
  - Concrete Pavement Repair Locations
  - Coring data and locations
  - Salvage base summary
- Earthwork
  - Label locations and quantities of borrow entered into mass diagram
  - Label locations and quantities of hauled materials from side roads etc. entered into mass diagram
  - Label average haul
  - Label locations and quantities of special excavation and subcut
  - Label locations and quantities of clearing and grubbing and topsoil removal
  - Label locations and quantities of topsoil borrow

- Label locations and quantities for approaches, drives, etc.
- Borrow areas
- PE Signature Block

#### H. Section 020 - General Details Sheets

- Review need of common details
  - Grading
  - Slope flattening
  - Subgrade repair areas
  - Pipe extensions
  - Underdrain areas and associated drawings
  - Flared intersection layouts and approach
  - Bridge end and railroad crossing
  - Erosion control details
  - Milling
  - PCC pavement (dowels, tie bars, joints, reinforcement over pipe, etc.)
  - Ramp layouts
  - Edgedrains and headwalls
  - Edgedrain connection to manhole or inlet
  - Median and turning lane details
  - Cross over and ramp connections
  - Energy dissipater details
  - Lift station details
  - Floating manhole casting
  - Utility, Trench, Pipe backfill details
  - Stabilized Construction Access
  - Wetland easements
- Dimension clarity
- Cross referencing of details by sheet heading
- PE Signature Block

#### I. Section 030 - Typical Sections Sheets (Existing and Proposed)

- Dimensions
- Location by stations and Reference Points (RP)
- Profile and survey location
- Crown rates and superelevation
- Material classifications
- HBP: show aggregate and pavement width, thickness, and areas
- PCC: show aggregate and pavement width, thickness, areas, joints, dowel bars, reinforcing, and tiebars.
- Curb and gutter
- Edgedrains
- Pipe installations
- Foreslope, ditch width, and backslope if applicable
- Geotextile Fabric
- Excavation limits and/or areas (common, class, subcut, muck)
- Waste areas (within cross section)

- Sodding/Hydromulching limits
- Existing typical section should show patching with a variable depth (for blended base projects)
- PE Signature Block

**J. Section 040 - Removals**

- Layout of removal limits
- PE Signature Block

**K. Section 050 - Inlet and Manhole Summary**

- Drainage details
  - Culvert summary sheets (location, type, size, length)
- Hydraulic data for pipe greater than 30 inches (100 yr and design frequency yr)
- Storm drain summary sheets (location number, location, description, top elev., invert elev., base elev., riser length, casting type, position of incoming lines and inverts). This information may be shown on plan and profile for smaller projects.
- PE Signature Block

**L. Section 055 - Drainage Layouts**

- Show direction of drainage flows (ditches, culverts, storm drain)
- PE Signature Block

**M. Section 060 - Plan & Profile Sheets**

- Dimensional clarity
- North arrow
- Label businesses
- Show and label horizontal alignment control points and ties, curve data and superelevation rates, etc. (move survey and alignment information to layout sheets if sheets are too cluttered)
- Show and label vertical alignment grades, curve data, sight distance data, locations and stations of barrier stripes, etc.
- Show and dimension existing right of way, proposed right of way, construction easements, drainage easements, section lines, etc.
- Show and label driveway widths, lengths, and locations
- Show and label curb ramps
- Earthwork
  - Label mile split quantities
  - Label locations and quantities of borrow entered into mass diagram
  - Label locations and quantities of hauled materials from side roads etc. entered into mass diagram
  - Label average haul
  - Label locations and quantities of special excavation and subcut
  - Label locations and quantities of clearing and grubbing and topsoil removal
  - Label locations and quantities of topsoil borrow
  - Label locations and quantities for approaches, drives, etc.

- Show and label bypass locations, horizontal and vertical alignments, and quantities
- Show and Label all ditch grades and ditch blocks
- Show and label Riprap foundation fill, erosion control locations, retaining walls, etc.
- Label and show erosion control (may include in basis of estimate or as detail sheet)
- Culverts
  - Label removal and/or plug locations
- Storm drains (inlets and manholes)
  - Check number of inlets or manholes to match summary and quantity sheets
  - Check type of inlet and casting
  - Check manhole size to accommodate storm drain line sizes
  - Check elevations
  - Check riser lengths to elevations shown
  - Check offset locations (offset distance to center of riser)
  - Check length of storm drain lines
  - Check if city or district want insulation on inlets
  - Check if city or district want a minimum depth for inlets
- Water and sanitary lines
  - Check with city on location and installation (may be shown on separate plan and profile sheets)
  - Show and label direction of drainage flow (ditches, culverts, storm drain)
  - Check existing underground utilities for details (elevation and location)
  - Cross reference detail sheets that apply
  - List pay item quantities
  - Make sure all changes are corrected on related sheets and quantities
  - PE Signature Block

#### N. Section070 - Contours Sheets

- PE Signature Block

#### O. Section 080 - Layouts Sheets (Survey Data, Fencing, etc.)

- Survey control point data sheet included in plans
- If the plan and profile become cluttered, it may be necessary to provide separate sheets for the alignment data, removal data, etc.
- Dimension clarity
- PE Signature Block

**P. Section 090 - Paving Layout Sheets (information may be on plan and profile)**

- Dimension clarity
- Show survey and office location designation
- Show and label joint spacing, locations, type, tie bars, seal, etc.
- Show and label lane and shoulder widths
- Show and label pavement reinforcement over pipe
- Show and label driveways, sidewalks, curb ramps, median paving etc.
- List pay item quantities by page
- PE Signature Block

**Q. Section 100 - Work Zone Traffic Control Sheets**

- Develop work zone traffic control note (identify construction phasing, restrictions, maintenance of access, applicable standard drawings, etc.)
- Develop work zone traffic control details and layouts (construction phasing and/or special considerations, show and label signing, devices, markings, etc.)
- Develop "Traffic Control Devices List"
- Review need for special signs
- Review need for traffic control supervisor
- Review work zone speed limits guidelines
- Review edge drop off guidelines and notes
- Review warrants for portable changeable message signs
- Check if detours are required
- Check if temporary bypasses are required
- Give Traffic Section a copy of plans to review the traffic control
- PE Signature Block

**R. Sections 110 & 120 - Signing and Markings Sheets**

- Advise Design Division Traffic Section of changes and/or revisions
- Coordinate data for typical section, horizontal and vertical alignment
- Obtain estimated quantities, spec and code
- See Also: Plan Design and Development Checklist Traffic Control Design in this Appendix
- PE Signature Block

**S. Section 130 - Guardrail Sheets**

- Advise Design Division Traffic Section of changes and/or revisions
- Coordinate data for typical section, horizontal and vertical alignment
- Obtain estimated quantities, spec and code
- See Also: Plan Design and Development Checklist Traffic Control Design in this Appendix
- PE Signature Block

**T. Sections 140 & 150 - Lighting and Signals Sheets**

- Advise Design Division Traffic Section of changes and/or revisions
- Coordinate data for typical section, horizontal and vertical alignment
- Obtain estimated quantities, spec and code
- See Also: Plan Design and Development Checklist Traffic Control Design in this Appendix
- PE Signature Block

**U. Section 160 - ITS Sheets**

- PE Signature Box

**V. Section 170 - Bridge and Box Culverts Sheets**

- Advise Bridge Division of changes and/or revisions
- Coordinate data for typical section, horizontal and vertical alignment
- Obtain estimated quantities, spec and code
- PE Signature Block

**W. Sections 175 & 180 - Soils Boring Logs & Pit Plats Sheets**

- Insert soil profile and/or cross section sheets form Materials and Research
- Insert pit plat sheets form Materials and Research
- Included in plans

**X. Section 190 - Haul Road Restrictions Sheets**

- Insert haul road restrictions sheets
- Included in plans

**Y. Section Right of Way Plot Sheets**

- PE Signature Block

**Z. Cross Sections Sheets**

- Included in plans

**AA. Section 200 - Cross Sections Sheets**

- If earthwork sheets are not included, add cut and fill quantities to sections
- Run cross sections with marked points for future reports generated by district
- Show and label inlets and manholes
- Cross reference to plan and profile
- Check slopes and grade line to match existing terrain and within right of way limits

**BB. Standard Drawings Sheets**

- \_\_\_ Review list of standard drawings and add appropriate drawings
- \_\_\_ Standard Drawings to be listed on Table of Contents of plans (include standards from other Sections and Divisions)
- \_\_\_ Include required Standard Drawings in the back of the original plans only. Print the required Standard Drawings from the web at <http://www.dot.nd.gov/manuals/design/designmanual/designmanual.htm> under Standard Drawings.



**PLAN DESIGN AND DEVELOPMENT CHECKLIST - TRAFFIC CONTROL DESIGN  
(SIGNING, PAVEMENT MARKING, GUARDRAIL, LIGHTING, TRAFFIC SIGNALS)**

**A. Signing**

1. Check safety review for recommendations for signs with A-frames and other substandard signs.

Comment. \_\_\_\_\_

2. Compare Sign Locations and Layout information with Sign Summary Sheet.

Comment. \_\_\_\_\_

3. Check Junction signing for placement and distance from intersections.

Comment. \_\_\_\_\_

- a. Stop Conditions, Route Turn Markers across the intersections.

Comment. \_\_\_\_\_

- b. Check lighting plans to see if signs can be placed on light standards.

Comment. \_\_\_\_\_

- c. Distance and Destination sign legends to be checked with District Maps from Operations Section in Planning/Asset Management Division.

Comment. \_\_\_\_\_

4. Sign Supports.

- a. Check lengths on summary sheets.

Comment. \_\_\_\_\_

- b. Check breakaway types - round pipe

1. Type A Single Post Signs

Comment. \_\_\_\_\_

2. Type B Two Post Signs with post spacing less than 8 feet.

Comment. \_\_\_\_\_

3. Type C Two Post or More Signs with post spacing 8 feet or more.

Comment. \_\_\_\_\_

4. Check fuse joint requirements.

Comment. \_\_\_\_\_

- c. Multi-Direction Breakaway Bases - Round pipe to be used at ramp terminals where post can be struck in any direction.

Comment. \_\_\_\_\_

- d. Sign Areas

1. Primary and Secondary Signs.

- a. Type 2 - Reflective Sheeting. All sign backgrounds except as listed in b.

Comment. \_\_\_\_\_

- b. Type 3a - Reflective Sheeting. Stop Signs, Yield Signs, Do Not Enter Signs, Wrong Way Signs, All Yellow Warning Signs, Legends of Green, Blue, and Brown Background Signs.

Comment. \_\_\_\_\_

2. Interstate Highway Signs.

- a. Check to see if signs have notes on layouts requiring type 3a retroreflective sheeting for signs.

Comment. \_\_\_\_\_

5. Check if standards drawings that are required have been provided.

Comment. \_\_\_\_\_

6. Check if special notes for this project are provided.

Comment. \_\_\_\_\_

7. Check if Standard Notes are provided. Section 754 Standard Notes can be found on the web at <http://www.ugpti.org/dotsc/prepguide/index.php> under Standard Notes.

Comment. \_\_\_\_\_

8. Check if cost estimate items and cost are correct.

Comment. \_\_\_\_\_

9. Check sign design layout sheets for station color and area.

Comment. \_\_\_\_\_

10. Check special assembly layouts for sign sizes and correct station.

Comment. \_\_\_\_\_

**B. Pavement Markings**

1. Check Pavement Marking Material Selection Chart. The materials shall meet these requirements.

Comment. \_\_\_\_\_

2. The center line for two-lane, two-way roadways shall be yellow.

Comment. \_\_\_\_\_

3. The left edge line for divided highways shall be yellow.

Comment. \_\_\_\_\_

4. Layouts shall have width and color of line shown.

Comment. \_\_\_\_\_

5. The pay items shall be listed on plan layouts showing the material, color, type of line and quantity. Each width of line shall be totaled. Check totals. Compare line widths and color with what is shown on layouts.

Comment. \_\_\_\_\_

6. Check if Standard Drawings have been provided.

Comment. \_\_\_\_\_

7. Check if special notes for this project are provided.

Comment. \_\_\_\_\_

8. Check if items and costs are provided.

Comment. \_\_\_\_\_

9. Check if Standard Notes are provided. Section 762 Standard Notes can be found on the web at <http://www.ugpti.org/dotsc/prepguide/index.php> under Standard Notes.

Comment. \_\_\_\_\_

10. Check if special notes are provided.

Comment. \_\_\_\_\_

**C. Guardrails**

1. Check safety reviews to see if guardrail is proposed.

Comment. \_\_\_\_\_

2. Review concept report for guardrail requirements.

Comment. \_\_\_\_\_

3. Determine if guardrail embankment is to be placed with grading or a separate item.

Comment. \_\_\_\_\_

4. Check to determine if special notes are required.

Comment. \_\_\_\_\_

5. Check if Standard Drawings have been provided.

Comment. \_\_\_\_\_

6. Check if items and costs are provided.

Comment. \_\_\_\_\_

7. Check if standard notes are provided. Section 764 Standard notes can be found on the web at <http://www.ugpti.org/dotsc/prepguide/index.php> under Standard Notes.

Comment. \_\_\_\_\_

**D. Lighting**

1. Interim Lighting.

- a. Check Layout to determine if permanent lighting will interfere with interim lighting.

Comment. \_\_\_\_\_

- b. Check to determine if pedestrians can negotiate around interim lighting and construction area.

Comment. \_\_\_\_\_

- c. Check to see that underground and overhead utilities do not interfere with placement of poles, anchors, and wires.

Comment. \_\_\_\_\_

- d. Check that permanent signal will fit while interims are operating.

Comment. \_\_\_\_\_

- e. Check summary of quantities conduit and cable runs and notes.

- 1. Items to be bid as each.

Comment. \_\_\_\_\_

2. Permanent Lighting.

- a. Check Layout to determine if permanent lighting will fit interim lighting.

Comment. \_\_\_\_\_

- b. Check to determine if pedestrians will be able to negotiate around light poles.

Comment. \_\_\_\_\_

- c. Check to see if break-away bases are required.

Comment. \_\_\_\_\_

- d. Check location if in the way of construction.

Comment. \_\_\_\_\_

- e. Check to see that underground and overhead utilities do not interfere with placement of poles and mast arms.

Comment. \_\_\_\_\_

- f. Check if festoon circuit is required.

Comment. \_\_\_\_\_

- g. Check that pull box locations are shown on the plan layout.

Comment. \_\_\_\_\_

- h. Check if stations of layout items agree with quantity calculations and quantity sheet.

Comment. \_\_\_\_\_

- i. Check feed point location.

Comment. \_\_\_\_\_

- j. Check summary of quantities conduit and cable runs.

Comment. \_\_\_\_\_

- k. Check if special feed point requirements are needed and a layout.

Comment. \_\_\_\_\_

- l. Check if note is provided when removed equipment is not to become property of the state.

Comment. \_\_\_\_\_

- m. Check if all side street lighting has power provided.

Comment. \_\_\_\_\_

- n. Check if Lighting Standards have been provided.

Comment. \_\_\_\_\_

- o. Check if items and costs are provided.

Comment. \_\_\_\_\_

- 3. Check to determine if special notes are required.

Comment. \_\_\_\_\_

- 4. Check if standard notes are provided. Section 770 Standard notes can be found on the web at <http://www.ugpti.org/dotsc/prepguide/index.php> under Standard Notes.

Comment. \_\_\_\_\_

- 5. Check if Utility Company Feed Point Letter is Prepared.

Comment. \_\_\_\_\_

**E. Traffic Signals**

1. Interim Traffic Signal

- a. Check Layout to determine if permanent signals are behind interim signals.

Comment. \_\_\_\_\_

- b. Check to determine if pedestrian signals are needed. If replacing in-place signals that are in the way of construction, and pedestrian signals are in place, pedestrian signals are needed in the interim.

Comment. \_\_\_\_\_

- c. Check to see that underground and overhead utilities do not interfere with placement of poles, anchors and placement of span wires.

Comment. \_\_\_\_\_

- d. Check that poles and anchors do not interfere with pedestrians.

Comment. \_\_\_\_\_

- e. Check so that permanent signals will fit while interims are operating.

Comment. \_\_\_\_\_

- f. Check note on coiling enough cable for relocation of signal heads during different phases.

Comment. \_\_\_\_\_

- g. Check if interim item is placed on the plan layout.

Comment. \_\_\_\_\_

- h. Check if interim signal heads have 2 signal heads in each direction and have a dimension of at least 8 feet between.

Comment. \_\_\_\_\_

- i. Check cable runs with signal head numbers.

Comment. \_\_\_\_\_

- j. Check to see if signal head and traffic volume layouts are shown.

Comment. \_\_\_\_\_

- k. Check timing, phasing, cam breakout, notes and flashing requirements.

Comment. \_\_\_\_\_

- l. Check summary of quantities conduit and cable runs and notes.

- 1. Items to be bid as each.
- 2. State furnished items.
- 3. These items to be wood pole mounted.

Comment. \_\_\_\_\_

- m. Check if interim signals need to be coordinated.

Comment. \_\_\_\_\_

2. Permanent Traffic Signals.

- a. Check Layout to determine if permanent signals are behind interim signals.

Comment. \_\_\_\_\_

- b. Check if near side signals are required.

Comment. \_\_\_\_\_

- c. Check if the signal standards are within the clear zone.

Comment. \_\_\_\_\_

- d. Check to determine if pedestrian signals are needed.

Comment. \_\_\_\_\_

- e. Check location so that signal is not in the way of construction and that pedestrian signals are in place near crosswalk.

Comment. \_\_\_\_\_



- f. Check that lane width and all other street dimensions are shown.

Comment. \_\_\_\_\_

- g. Check to see that underground and overhead utilities do not interfere with placement of poles and mast arms.

Comment. \_\_\_\_\_

- h. Check the need for pedestrian actuation push buttons other than on signal poles.

Comment. \_\_\_\_\_

- i. Check if signals have 2 signal heads for through movement in each direction and have a dimension of at least 8 feet between.

Comment. \_\_\_\_\_

- j. Check that signal and pedestrian heads are positioned so they match standard drawings.

Comment. \_\_\_\_\_

- k. Check if pedestrian push button sign location number and direction it's facing are shown on plan layout.

Comment. \_\_\_\_\_

- l. Check that pull box locations are shown on the plan layout.

Comment. \_\_\_\_\_

- m. Check if emergency vehicle preemption location and number are shown on plans.

Comment. \_\_\_\_\_

- n. Check cable runs with signal head numbers and color coding.

Comment. \_\_\_\_\_

- o. Check that combination signal and light standards have lighting conductors only entering the pole base.

Comment. \_\_\_\_\_

- p. Check to see if signal head and traffic volume layouts are shown.

Comment. \_\_\_\_\_

- q. Check if stations of layout items agree with quantity calculations and quantity sheet.

Comment. \_\_\_\_\_

- r. Check timing, phasing, cam breakout, notes and flashing requirements.

Comment. \_\_\_\_\_

- s. Check if emergency vehicle preemption is used and that phasing is shown.

Comment. \_\_\_\_\_

- t. If existing signals are being removed, show layout and list removed items and quantity.

Comment. \_\_\_\_\_

- u. Check if note is provided when removed equipment is not to become property of the state.

Comment. \_\_\_\_\_

- v. Check traffic signal cross section to be sure the signal location and stationing agree with other layouts. Check if street name signs are the same as shown on signing plans.

Comment. \_\_\_\_\_

- w. Check controller location and direction of door opening.

Comment. \_\_\_\_\_

x. Check summary of quantities conduit and cable runs and notes.

1. Internal wiring note.
2. Emergency vehicle indicator light conductor.
3. Emergency vehicle detector cable.
4. Indicate internal wire quantities.

Comment. \_\_\_\_\_

y. Check if signal heads on signal poles at cross section are located correctly.

Comment. \_\_\_\_\_

z. Check if signs for signal head requirements are same as signing plan layouts.

Comment. \_\_\_\_\_

aa. Check if signal progression is required in plans and check progression layout for content, etc.

Comment. \_\_\_\_\_

bb. Check if emergency vehicle preemption needs advance detection.

Comment. \_\_\_\_\_

cc. Check to see if interconnect conductor to be placed between intersections. Interconnect shall be in separate conduit. Pull boxes shall be placed every 500 feet maximum.

Comment. \_\_\_\_\_

dd. Check to see if railroad signal interconnect is provided or necessary.

Comment. \_\_\_\_\_

ee. Detector loops shall be numbered, showing the number of amplifiers, number of turns, sizes, type of loop, number of preformed loops, and number of micro-loops both double and single prop sets.

Comment. \_\_\_\_\_

ff. Check if speed monitoring is required.

Comment. \_\_\_\_\_

3. Check if special feed point requirements and layout are needed.

Comment. \_\_\_\_\_

4. Check if Standard Drawings have been provided.

Comment. \_\_\_\_\_

5. Check if items and costs are provided.

Comment. \_\_\_\_\_

6. Check to determine if special notes are required.

Comment. \_\_\_\_\_

7. Check if standard notes are provided. Section 772 Standard notes can be found on the web at <http://www.ugpti.org/dotsc/prepguide/index.php> under Standard Notes

Comment. \_\_\_\_\_

8. Check if the utility company feed point letter is prepared.

Comment. \_\_\_\_\_

## **Plan Review**

The following information is provided:

- Information to be brought Plan Review Meetings
- Plan Design and Development Checklist – Abbreviated

### Information to be brought to Plan Review Meetings

The following checklist is meant to help the designer make sure the appropriate information is taken to the following meetings: the Preliminary Plan Review (PPR), Plans, Specifications, & Estimates (PS&E), and the Final Office Plan Review (FOPR). Place a checkmark in the blank as appropriate, or N/A if not applicable.

<u>PPR</u>	<u>PS&amp;E</u>	<u>FOPR</u>	<u>Information to be brought to the meeting</u>
<input type="checkbox"/>	<input type="checkbox"/>		Environmental Document or Environmental documentation (CATEX, FONSI, or ROD)
<input type="checkbox"/>	<input type="checkbox"/>		Traffic Operations Report
<input type="checkbox"/>	<input type="checkbox"/>		Surface thickness recommendations
<input type="checkbox"/>	<input type="checkbox"/>		Linear soil survey recommendations
<input type="checkbox"/>	<input type="checkbox"/>	<input type="checkbox"/>	Design Exceptions
<input type="checkbox"/>	<input type="checkbox"/>		Drainage Report
<input type="checkbox"/>	<input type="checkbox"/>		Right of Way Plats
<input type="checkbox"/>	<input type="checkbox"/>	<input type="checkbox"/>	Are there any P-notes that should become standard notes or standard notes that should be incorporated into the Spec Book?
<input type="checkbox"/>	<input type="checkbox"/>		Standard Specifications and Supplemental Specifications
<input type="checkbox"/>	<input type="checkbox"/>	<input type="checkbox"/>	Plan Sheets (PPR: 25-40%, PS&E: 90-100% and FOPR: stamped and signed or 100%)
<input type="checkbox"/>	<input type="checkbox"/>		Bid opening and plan completion dates
<input type="checkbox"/>	<input type="checkbox"/>	<input type="checkbox"/>	Milestone Activities
<input type="checkbox"/>	<input type="checkbox"/>	<input type="checkbox"/>	Engineer's Estimate, Environmental Document Estimate, and STIP programmed cost
	<input type="checkbox"/>	<input type="checkbox"/>	Special Provisions (PS&E: draft, FOPR: final) and list of SPs
	<input type="checkbox"/>	<input type="checkbox"/>	Previous plan review summaries (PS&E: Preliminary review, FOPR: PS&E review)

### Plan Design and Development Checklist – Abbreviated

The appropriate column should be complete prior to each review which includes: the Preliminary Plan Review (PPR); Plans, Specifications, & Estimates (PS&E); and the Final Office Plan Review (FOPR). Place N/A in the blank if not applicable. This checklist should be a living document throughout the life of this project. Place a checkmark in the appropriate blank as items are completed or received. The lead designer on the project is responsible for tracking the items below and keeping them on task. Prior to the completion of the final plans, the Designer should consider meeting with each section leader of the appropriate section and review their items. There is a blank at the bottom of this checklist for the designer to sign and print their name below the blank. Please note not all the blanks will be filled for each review. If your project does not require a certain item please write N/A in the blank.

<u>PPR</u>	<u>PS&amp;E</u>	<u>FOPR</u>	<u>Bridge - Hydraulics</u>
<input type="checkbox"/>	<input type="checkbox"/>	<input type="checkbox"/>	Drainage Report
<input type="checkbox"/>	<input type="checkbox"/>	<input type="checkbox"/>	Review underground (includes but not limited to storm (centerline and approach) and sanitary sewer, water main, inlet and outlet elevations, length, size, type, inlet and manhole size and depth, etc.)
<input type="checkbox"/>	<input type="checkbox"/>	<input type="checkbox"/>	Adequate drainage in median (if applicable)
<u>PPR</u>	<u>PS&amp;E</u>	<u>FOPR</u>	<u>Bridge - Structures</u>
<input type="checkbox"/>	<input type="checkbox"/>	<input type="checkbox"/>	Preliminary Engineering Meeting, 5% plan complete, complete and submit to Bridge Engineer
<input type="checkbox"/>	<input type="checkbox"/>	<input type="checkbox"/>	Calculations (consultants submit to Bridge Division) 50% plans complete
<input type="checkbox"/>	<input type="checkbox"/>	<input type="checkbox"/>	Design sketches for bridges, 50% plans complete
<input type="checkbox"/>	<input type="checkbox"/>	<input type="checkbox"/>	90% plan submittal one month prior to PS&E Checklist for Bridge Plans (SF 17180)
<input type="checkbox"/>	<input type="checkbox"/>	<input type="checkbox"/>	
<input type="checkbox"/>	<input type="checkbox"/>	<input type="checkbox"/>	Structural sheets
<u>PPR</u>	<u>PS&amp;E</u>	<u>FOPR</u>	<u>Design</u>
<input type="checkbox"/>	<input type="checkbox"/>	<input type="checkbox"/>	Title Sheet
<input type="checkbox"/>	<input type="checkbox"/>	<input type="checkbox"/>	Note Sheets
<input type="checkbox"/>	<input type="checkbox"/>	<input type="checkbox"/>	Quantity Sheets

- |                          |                          |                          |  |
|--------------------------|--------------------------|--------------------------|--|
| <input type="checkbox"/> | <input type="checkbox"/> | <input type="checkbox"/> | Field Laboratory (type and need)   |
| <input type="checkbox"/> | <input type="checkbox"/> | <input type="checkbox"/> | Basis of Estimate  |
| <input type="checkbox"/> | <input type="checkbox"/> | <input type="checkbox"/> | Special Provisions   |
| <input type="checkbox"/> | <input type="checkbox"/> | <input type="checkbox"/> | Detail Sheets  |
| <input type="checkbox"/> | <input type="checkbox"/> | <input type="checkbox"/> | Typical Section Sheets   |
| <input type="checkbox"/> | <input type="checkbox"/> | <input type="checkbox"/> | Removal requirements   |
| <input type="checkbox"/> | <input type="checkbox"/> | <input type="checkbox"/> | Plan and Profile Sheets  |
| <input type="checkbox"/> | <input type="checkbox"/> | <input type="checkbox"/> | Horizontal and vertical alignments   |
| <input type="checkbox"/> | <input type="checkbox"/> | <input type="checkbox"/> | Label surface of profile   |
| <input type="checkbox"/> | <input type="checkbox"/> | <input type="checkbox"/> | Utilities  |
| <input type="checkbox"/> | <input type="checkbox"/> | <input type="checkbox"/> | Cross Section Sheets   |
| <input type="checkbox"/> | <input type="checkbox"/> | <input type="checkbox"/> | Earthwork calculations (ex. shrinkage, borrow, earthwork computation summary, checking output quantities)  |
| <input type="checkbox"/> | <input type="checkbox"/> | <input type="checkbox"/> | Get information to those that need it (i.e. environmental, materials and research, etc.)                   |
| <input type="checkbox"/> | <input type="checkbox"/> | <input type="checkbox"/> | Borrow Requirements  |
| <input type="checkbox"/> | <input type="checkbox"/> | <input type="checkbox"/> | Access Requirements  |
| <input type="checkbox"/> | <input type="checkbox"/> | <input type="checkbox"/> | Stay within project concepts   |
| <input type="checkbox"/> | <input type="checkbox"/> | <input type="checkbox"/> | FHWA approval for changes to Environmental Document or scope of work                                       |
| <input type="checkbox"/> | <input type="checkbox"/> | <input type="checkbox"/> | Have other appropriate people look through plans   |
| <input type="checkbox"/> | <input type="checkbox"/> | <input type="checkbox"/> | Detours  |
| <input type="checkbox"/> | <input type="checkbox"/> | <input type="checkbox"/> | Temporary surfacing for winter suspension of work satisfactory.  |
| <input type="checkbox"/> | <input type="checkbox"/> | <input type="checkbox"/> | All work activities covered by specification, supplemental specification, special provision, or plan note. |



<input type="checkbox"/>	<input type="checkbox"/>	<input type="checkbox"/>	All work activities that are not covered by a standard pay item are included in price bid for another item.
<input type="checkbox"/>	<input type="checkbox"/>	<input type="checkbox"/>	Bid opening and completion dates
<input type="checkbox"/>	<input type="checkbox"/>	<input type="checkbox"/>	Update milestone activities
<input type="checkbox"/>	<input type="checkbox"/>	<input type="checkbox"/>	Prepare engineer's cost estimate and compare to STIP
<input type="checkbox"/>	<input type="checkbox"/>	<input type="checkbox"/>	City cost share and Funding Splits
<input type="checkbox"/>	<input type="checkbox"/>	<input type="checkbox"/>	Disposition and certification of city utilities and adjustments
<input type="checkbox"/>	<input type="checkbox"/>	<input type="checkbox"/>	Review any unresolved issues
<input type="checkbox"/>	<input type="checkbox"/>	<input type="checkbox"/>	Review any unique situations for this project

PPRPS&EFOPRDesign - Survey & Photogrammetry

<input type="checkbox"/>	<input type="checkbox"/>	<input type="checkbox"/>	Aerial Photos
<input type="checkbox"/>	<input type="checkbox"/>	<input type="checkbox"/>	Right of Way Plats
<input type="checkbox"/>	<input type="checkbox"/>	<input type="checkbox"/>	Additional Survey Required
<input type="checkbox"/>	<input type="checkbox"/>	<input type="checkbox"/>	Survey Transmittal (i.e. survey alignment, tin file, etc.)

PPRPS&EFOPRDesign - Traffic

<input type="checkbox"/>	<input type="checkbox"/>	<input type="checkbox"/>	Traffic control and construction phasing requirements, access for residents and businesses during construction
<input type="checkbox"/>	<input type="checkbox"/>	<input type="checkbox"/>	Work Zone Traffic Control Sheets
<input type="checkbox"/>	<input type="checkbox"/>	<input type="checkbox"/>	Signing, Pavement Marking, Guardrail, Lighting, and Signal Sheets

<u>PPR</u>	<u>PS&amp;E</u>	<u>FOPR</u>	<u>ETS - Environmental</u>
<input type="checkbox"/>	<input type="checkbox"/>	<input type="checkbox"/>	404 - Permit
<input type="checkbox"/>	<input type="checkbox"/>	<input type="checkbox"/>	Floodplain Permit
<input type="checkbox"/>	<input type="checkbox"/>	<input type="checkbox"/>	List Other Permits
<hr/>			
<input type="checkbox"/>	<input type="checkbox"/>	<input type="checkbox"/>	Acres of disturbance to Environmental Section for NPDES
<input type="checkbox"/>	<input type="checkbox"/>	<input type="checkbox"/>	Wetland limits drawn on plan view and cross sections
<input type="checkbox"/>	<input type="checkbox"/>	<input type="checkbox"/>	Environmental commitments sheet
<input type="checkbox"/>	<input type="checkbox"/>	<input type="checkbox"/>	Erosion control methods included in plans
<input type="checkbox"/>	<input type="checkbox"/>	<input type="checkbox"/>	Final environmental approval (CATEX, FONSI, or ROD)
<input type="checkbox"/>	<input type="checkbox"/>	<input type="checkbox"/>	Final Wetland Impact Table to Environmental Section
<u>PPR</u>	<u>PS&amp;E</u>	<u>FOPR</u>	<u>ETS – Right of Way</u>
<input type="checkbox"/>	<input type="checkbox"/>	<input type="checkbox"/>	Right of Way limits delivered
<input type="checkbox"/>	<input type="checkbox"/>	<input type="checkbox"/>	Obtaining easements
<input type="checkbox"/>	<input type="checkbox"/>	<input type="checkbox"/>	Clear encroachments
<input type="checkbox"/>	<input type="checkbox"/>	<input type="checkbox"/>	Permanent right of way acquisition
<input type="checkbox"/>	<input type="checkbox"/>	<input type="checkbox"/>	Material Source Approval (Spec 107.04)
<input type="checkbox"/>	<input type="checkbox"/>	<input type="checkbox"/>	Material Source Worksheet has been completed and submitted (SFN 58466). This form is good for six (6) months.
Environmental and Cultural Resource Clearance:			
<input type="checkbox"/> Yes <input type="checkbox"/> No			

<u>PPR</u>	<u>PS&amp;E</u>	<u>FOPR</u>	<u>ETS – Technical Services Section</u>
<input type="checkbox"/>	<input type="checkbox"/>	<input type="checkbox"/>	Supplemental Specifications
<input type="checkbox"/>	<input type="checkbox"/>	<input type="checkbox"/>	Special Provisions
<u>PPR</u>	<u>PS&amp;E</u>	<u>FOPR</u>	<u>Materials and Research Division</u>
<input type="checkbox"/>	<input type="checkbox"/>	<input type="checkbox"/>	Surface thickness recommendation
<input type="checkbox"/>	<input type="checkbox"/>	<input type="checkbox"/>	Linear soil recommendation
<input type="checkbox"/>	<input type="checkbox"/>	<input type="checkbox"/>	Material Source Approval (Spec 107.04)
<input type="checkbox"/>	<input type="checkbox"/>	<input type="checkbox"/>	Material Source Worksheet has been completed and submitted (SFN 58466). This form is good for six (6) months.
Environmental and Cultural Resource Clearance:			
<input type="checkbox"/> Yes <input type="checkbox"/> No			
<u>PPR</u>	<u>PS&amp;E</u>	<u>FOPR</u>	<u>Programming Division</u>
<input type="checkbox"/>	<input type="checkbox"/>	<input type="checkbox"/>	Traffic operations report
<input type="checkbox"/>	<input type="checkbox"/>	<input type="checkbox"/>	Cost Participation & Maintenance Agreements
<input type="checkbox"/>	<input type="checkbox"/>	<input type="checkbox"/>	Railroad Agreements
<input type="checkbox"/>	<input type="checkbox"/>	<input type="checkbox"/>	Railroad Survey (to be completed at Field Review)

As the designer I have done or had direct supervision over the items described above and to the best of my knowledge the information is correct.

Designer: \_\_\_\_\_

Reviewer: \_\_\_\_\_

Comments: \_\_\_\_\_

\_\_\_\_\_  
\_\_\_\_\_  
\_\_\_\_\_  
\_\_\_\_\_  
\_\_\_\_\_  
\_\_\_\_\_  
\_\_\_\_\_  
\_\_\_\_\_  
\_\_\_\_\_  
\_\_\_\_\_

## Final Office Plan Review Checklist

PCN: \_\_\_\_\_

The following items will be covered in the Final Office Plan Review.

\_\_\_\_\_ Checklist for Plan Design and Development – Abbreviated (Appendix III-01B)

\_\_\_\_\_ Are there any unresolved issues?

Comments: \_\_\_\_\_

\_\_\_\_\_ Additions/Changes to the Documented CatEx (DCE) or scope of work:

\_\_\_\_\_ DCE Re-evaluation

\_\_\_\_\_ DCE Addendum

\_\_\_\_\_ Are there any design exceptions?

\_\_\_\_\_ Are there any FHWA certification exceptions?

\_\_\_\_\_ Are there any unique items (unusual construction methods, measurements, or basis of payment; such as earthwork paid by the TON?)

\_\_\_\_\_ Are there any Sole Source or Proprietary Items?

\_\_\_\_\_ Public Interest Finding letter

\_\_\_\_\_ Are there any specified Completion Dates for any portion of the work?

\_\_\_\_\_ Is any portion of the project within National Grassland Boundaries?

\_\_\_\_\_ Railroad

\_\_\_\_\_ Crossings

\_\_\_\_\_ Signals

\_\_\_\_\_ Agreements

\_\_\_\_\_ Utilities

\_\_\_\_\_ Utility Certifications

\_\_\_\_\_ City Utility Disposition

\_\_\_\_\_ Airport Clearance Requirements/Permit

\_\_\_\_\_ NDDOT Owned Facilities – Contact NDDOT Utilities Engineer

*(Only applies to new installation or modification of Lighting, Signals, Beacons, Digital Message Signs, ATR, WIMS, RWIS, etc. NDDOT Utilities Engineer to update ND One Call database .)*

\_\_\_\_\_ Earthwork

\_\_\_\_\_ Shrinkage

\_\_\_\_\_ State Optioned Borrow – Completed SFN 9683 Borrow Area List?

\_\_\_\_\_ Contractor Furnished Borrow

\_\_\_\_\_ Earthwork computation summary *(What was done to check earthwork?)*

- \_\_\_\_\_ Environmental
- \_\_\_\_\_ 404 – Permit
- \_\_\_\_\_ Floodplain Permit
- \_\_\_\_\_ List Other Permits: \_\_\_\_\_
- \_\_\_\_\_ Erosion control methods included in plans
- \_\_\_\_\_ Environmental commitments sheet
- \_\_\_\_\_ Wetland limits drawn on plan and cross sections
- \_\_\_\_\_ Borrow Pits COA: \_\_\_\_\_ Yes \_\_\_\_\_ No
- \_\_\_\_\_ Materials Pits COA: \_\_\_\_\_ Yes \_\_\_\_\_ No
- \_\_\_\_\_ Final Wetland Impact Table to Environmental Section  
(*Wetland impacts in Final Plans matches Environmental Section's ledger*)
- \_\_\_\_\_ Right of Way
- \_\_\_\_\_ Right of Way Certification
- \_\_\_\_\_ Relocations
- \_\_\_\_\_ Summary of Estimated Costs:
- \_\_\_\_\_ *STIP Estimate:* \_\_\_\_\_
- \_\_\_\_\_ *DCE Estimate:* \_\_\_\_\_
- \_\_\_\_\_ *Engineer's Estimate:* \_\_\_\_\_
- \_\_\_\_\_ Are any required Cost Participation & Maintenance Agreements complete?
- \_\_\_\_\_ Special Provisions (SP):
- \_\_\_\_\_ TERO (*within 1 mile of reservation boundary*)
- \_\_\_\_\_ ITS
- \_\_\_\_\_ Erionite
- \_\_\_\_\_ Other: \_\_\_\_\_
- \_\_\_\_\_ SP's listed in the Table of Contents - Section 2 of the plans
- \_\_\_\_\_ *FHWA Risk-Based Stewardship and Oversight (RBSO)* indicated on the title sheet if applicable
- \_\_\_\_\_ Are all Structure Numbers shown on the title page?  
(*Structure Numbers are given to all Box Culverts, Separations, Interchanges, and metal culverts greater than 8 feet in diameter. See Bridge Listing book*)
- \_\_\_\_\_ RIMS Vertical Clearance entered in mainframe system for all structures?
- \_\_\_\_\_ If this project includes the sandblasting and painting of a structure or portions of a structure, has the Civil Rights Division been notified? This includes items associated with a structure such as a hand railing.
- \_\_\_\_\_ Review suggested improvements to design features.
- \_\_\_\_\_ Are there any plan notes that should be added to the Supplemental Specifications?
- \_\_\_\_\_ AARadme file completed for Design?



### III-03.01 Stationing

Stationing for projects should be according to the Surveys and Photogrammetry Manual.

### III-03.02 Horizontal Alignments, Vertical Alignments, Roadway Width, Foreslopes, Backslopes, Drive Slopes, Ditch Block Slope, Clear Zones, Sight Distance, and Superelevation

Generally, design two lane highways to eliminate the need for no-passing zone pavement markings wherever practicable. The requirements for no-passing zone pavement markings are discussed in Part 3B of the Manual on Uniform Traffic Control Devices (MUTCD). The minimum passing sight distances required to eliminate no-passing zone pavement markings are shown in Table 3B-1 of the MUTCD. See the appropriate *DESIGN GUIDELINES* in Section I-06.03 of this manual for other elements of design.

### III-03.03 Spiral Curve

Generally, spirals are used on rural highways for all curve radii equal to or less than Table 3-20 of *A POLICY*, “Maximum Radius for Use of a Spiral Curve Transition”. Curve radii greater than Table 3-20 shall use tangent curve transitions, as the effect of spiral curve transitions on lateral acceleration is likely to be negligible for radii larger than Table 3-20. When spiral curve transitions are used, they shall be designed in accordance to *A POLICY*.

### III-03.04 Interchanges

Interchanges should be designed according to *A POLICY*.

### III-03.05 Intersections

Flared intersections are shown on Standard Drawing D-203-6, and should generally be provided only on Minor Rehabilitation Grade Widening, Major Rehabilitation, and New/Reconstruction projects at locations of State to State highway intersections, and State to CMC (County Major Collector) intersections. Providing flared intersections at other locations, or on other project types, will require additional justification for NDDOT approval.

Rural approaches are shown on Standard Drawing D-203-8, and should generally be provided only on Minor Rehabilitation Grade Widening, Major Rehabilitation, and New/Reconstruction projects. Providing rural approaches larger than D-203-8, or on other project types, will require additional justification for NDDOT approval.

Recovery approaches are shown on Standard Drawing D-203-7. For more information, see Section III-03.05.04.

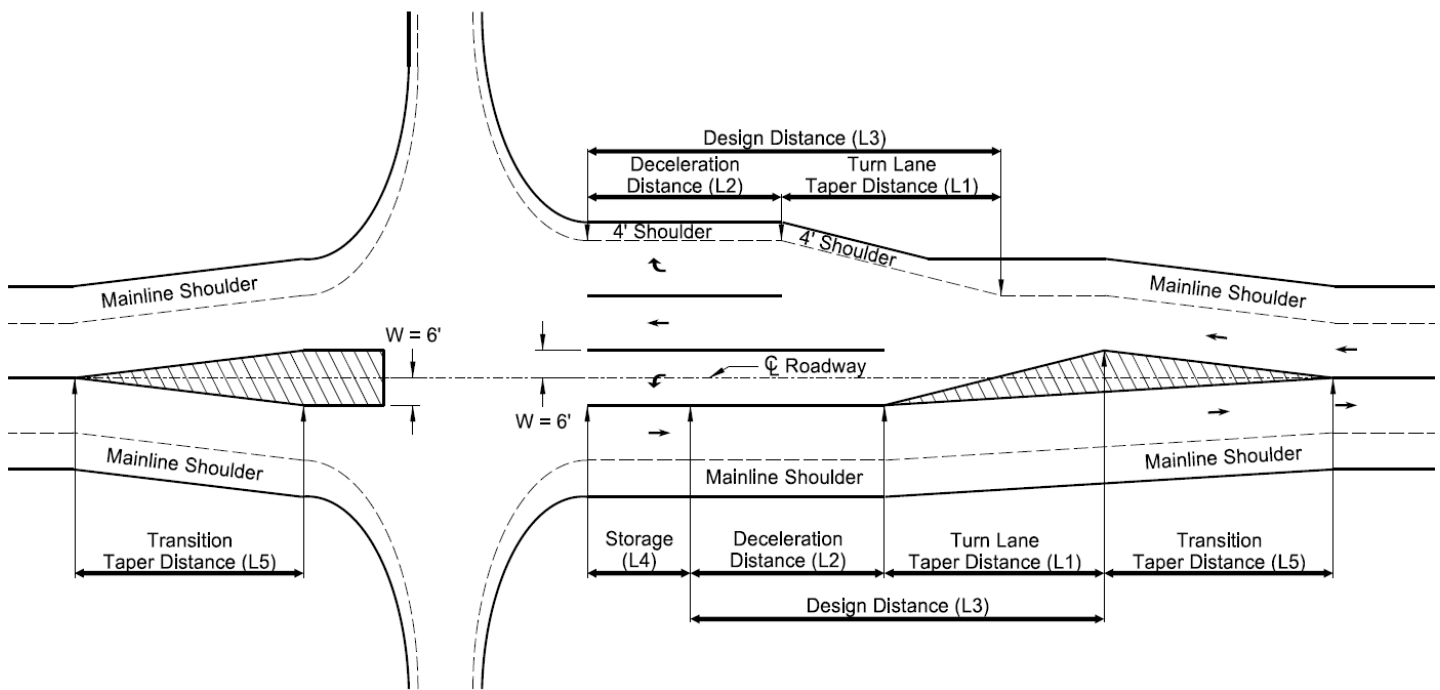


### III-03.05.01 Turning Lanes

This section addresses design elements for turn lanes. Generally, the need for turn lanes is addressed in a traffic operations study.

#### Uncontrolled Turn Lanes

An uncontrolled turn lane is defined as any turn lane in which no traffic signals or signs are used to control traffic movement within the turn lane. The diagram below shows the design elements of an uncontrolled turn lane.



(Drawing not to Scale)

#### **Taper (L1)**

L1 is the straight-line taper to be used to introduce the turn lane bay. Values range from 8:1 to 15:1 and are based on 2011 6<sup>th</sup> Edition of the AASHTO Green Book page 9-128.

#### **Deceleration (L2)**

L2 is the turn lane bay used for vehicle deceleration. Values based on 2011 6<sup>th</sup> Edition of the AASHTO Green Book page 9-126.

#### **Transition Taper (L5)**

L5 is the taper that through traffic is transitioned from centerline in order to introduce or drop additional lanes. Values based on Figure 3B-5 of the 2009 MUTCD on page 355.

DESIGN SPEED	TURN LANE TAPER	TURN LANE TAPER LENGTH (L1)	DECELERATION LENGTH (L2)	TOTAL DISTANCE (L3)	STORAGE (L4)		TRANSITION TAPER LENGTH (L5)
					LEFT TURNS	RIGHT TURNS	
30	8:1	96	75	171	L4 ≥ 100'  Traffic Ops Report or Table below. (whichever greater)	L4 = 0	L5=WS <sup>2</sup> /60
35	12:1	144	100	244			
40	12:1	144	150	294			
45	12:1	144	200	344			L5=WS
50	15:1	180	265	445			
55	15:1	180	335	515			
60	15:1	180	430	610			
65	15:1	180	530	710			
70	15:1	180	640	820			

### Storage (L4)

The minimum storage length for left turns is 100 feet. The following table or a traffic operations report will be used to determine the recommended storage length (L4) for left turn lanes. If a traffic operations report recommends a storage length that is in conflict with the table below, the larger value of the two storage lengths will be used.

The existing “average annual daily traffic” (AADT) and the existing “truck annual average daily traffic” (TAADT) represent 2-way traffic. For right turn lanes, in most cases no storage distance is necessary since vehicles do not yield to any other traffic movements (L4=0).

### Left Turn Lane Storage Distance (L4)

Distance in feet for 2-Lane Highway (4-Lane Highway in parenthesis)

EXISTING MINOR ROAD TRUCK VOLUME (TAADT)	EXISTING MAJOR ROAD VOLUME (AADT)			
	<5,000	5,000 - 10,000	10,000 - 20,000	> 20,000
<100	100(100)	100(100)	100(100)	150(125)
100-200	100(100)	100(100)	125(100)	200(175)
200-300	100(100)	125(100)	150(125)	250(225)
300-400	125(100)	150(125)	175(150)	350(325)
400-500	150(125)	175(150)	200(175)	450(300)
500-1000	175(150)	200(175)	400(300)	700(500)
1000-2000	275(250)	450(400)	700(600)	*
2000-3000	425(400)	650(600)	*	*
>3000	500(450)	700(650)	*	*

\*A traffic operations study should be done to determine storage length.

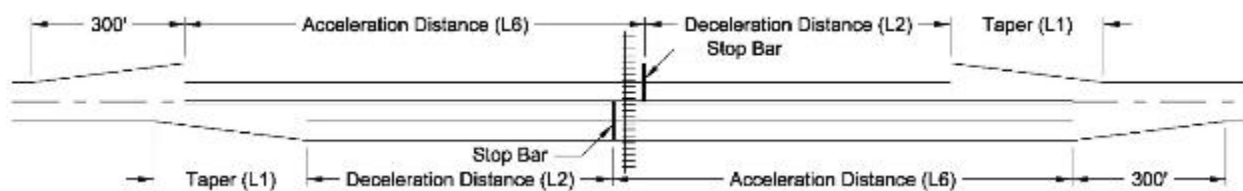
**Controlled Turn Lanes**

For a turn lane on an approach that is controlled by a stop sign, yield sign or traffic signal, the traffic operations study will indicate the recommended “full-width length” of the turn lane.

Note: the author of the traffic operations study takes into account the deceleration and storage distance as part of the recommended full-width length. However, the design of the taper distances (L1 and L5), should be applied to controlled turn lanes the same as uncontrolled turn lanes.

**III-03.05.02 Truck Acceleration and Deceleration Lanes at Railroad Crossings**

At railroad crossings, it can be necessary to provide hazardous trucks with acceleration and deceleration lanes where they can pull out of the main lane(s) of traffic, stop at the railroad crossing, accelerate, and merge back into traffic. For deceleration lengths, the values are the same as the above guidance for turn lanes. For acceleration lengths, the table below should be used to determine the length. The diagram below shows the basic concept of acceleration and deceleration lanes at railroad crossings.



(Drawing not to Scale)

**Acceleration and Deceleration Length for Railroad Crossings**

DESIGN SPEED, MPH (V)	DECELERATION LANE TAPER RATE	DECELERATION LANE TAPER LENGTH, FT (L1)	DECELERATION LANE LENGTH, FT (L2)	ACCELERATION LANE LENGTH <sup>1</sup> , FT (L6)
30	8:1	96	75	180
35	12:1	144	100	280
40	12:1	144	150	360
45	12:1	144	200	560
50	15:1	180	265	720
55	15:1	180	335	960
60	15:1	180	430	1200
65	15:1	180	530	1410
70	15:1	180	640	1620

<sup>1</sup> Table 10-3 AASHTO, A Policy on Geometric Designs of Highways and Streets, 2011 6th Edition

**III-03.05.03 Radial “T” Intersection Guide**

Generally, this type of intersection is used to eliminate tangent approaches at an intersection located within a horizontal curve.

- Whether or not to use this intersection should be discussed in the environmental document or decision document.
- Use for section line or county roads that intersect a state highway.
- Where two (2) state highways intersect, the traffic volumes will be reviewed to determine if the existing curve should be removed and replaced with a regular T or a radial T intersection.
- Where the Radial T is constructed the following criteria should be used:
  - The desirable superelevation on the curve should not exceed .04 ft/ft with a maximum of .06 ft/ft.
  - The horizontal curve should not exceed a curvature of 2 degrees 30 minutes.
  - The maximum grade on the curve should not exceed 2%.
  - The maximum breakover between the adjoining road and the curve portion of the pavement should not exceed 5%.
  - To improve the visibility of the intersection for vehicles traveling on the low side of the curve, delineators should be placed along both sides of the adjoining road including the radii.
  - The adjoining road should have a 50 foot level space just prior to reaching the state highway.
  - The shoulder on the high side of the curve should also be flattened to improve visibility.

**III-03.05.04 Recovery Approaches**

North Dakota Century Code:

**24-01-49. Approach or escape road to be built at all dead end roads or intersection of county and state highways.** *Whenever any highway on the state or county highway system has an intersection or dead end, there must be constructed, whenever feasible, an approach or escape road, and when not feasible other protective devices such as warning signs, rumble strips, or barricades. This section applies to new road construction and reconstruction after July 1, 1975.*

Intersection conditions where the construction of a recovery approach is not feasible must be discussed in the environmental document or decision document. The determination not to construct a recovery approach should be a decision item for approval by the Deputy Director for Engineering. Unfeasible conditions usually involve other roadway hazards such as: recovery approach that would lead into a lake, wetlands, rip-rap, steep back slope, deep ravine, or when extreme amounts of fill and right of way are needed. Note that some small wetlands can safely be traversed by the recovery approach.

Signing and/or rumble strips will be included in the intersection design when the Traffic Operations Section in the Programming Division has identified a crash problem.

There are 4 design scenarios for T-intersections:

1. A recovery approach will be constructed at all T-intersections of county and state highways, unless it is not feasible.
2. If a recovery approach is not feasible and a crash problem has not been identified, the intersection will be signed with intersection warning signs, Two-Direction Large Arrow sign (W1-7) and the T-Symbol sign (W2-4).
3. If a recovery approach is not feasible and a crash problem has been identified, the intersection will be signed with intersection warning signs, Two-Direction Large Arrow sign (W1-7) and the T-symbol sign (W2-4), and rumble strips may be installed as shown on standard drawing D-760-5.
4. If a recovery approach is feasible and a crash problem has been identified, a recovery approach will be constructed. The intersection will be signed with intersection warning signs, W1-7 and W2-4, and rumble strips may be installed as shown on standard drawing D-760-5.

If a recovery approach is constructed, a 90-1 survey should be conducted to determine what other safety work should be done to the portion of the approaching county or state highway which lies within the right of way of the highway being improved (Example: flattening of inslopes, relocation of pipes out of the clear zone).

Refer to standard drawing D-203-7 for guidance on the width, grade, radius, and location of recovery approaches in relation to the approaching highway. In addition, see Chapter III for signing requirements for a T-intersection.

The Traffic Operations Section of the Programming Division will provide the crash analysis and traffic control recommendations.

### III-04.01 Common Excavation

It is the intent to get all the common excavation from within the right of way without impacting environmentally sensitive areas such as wetlands, easement wetlands, and cultural resource areas. When all the useable material has been utilized, provisions for additional borrow are required.

### III-04.02 Borrow

Borrow is needed when there is insufficient dirt on the project from common excavation to build the roadway template. When borrow is required, it will be Department Optioned Borrow or Contractor Furnished Borrow.

There may be times when NDDOT will want to make the borrow area a mandatory borrow area. In that event, a public interest finding will be submitted to FHWA if federal funds are involved.

Try to obtain borrow close to where it is needed to keep the hauls as short as possible (desirably no more than 1 mile).

Generally, the following guide may be used for borrow:

- < 5,000 C.Y. – Contractor Furnished Borrow
- 5,000-10,000 C.Y. – If needed at multiple locations, such as a guardrail project, the contractor will furnish. If only needed at one location, consider Department Optioned Borrow.
- > 10,000 C.Y. – Department Optioned Borrow

A Borrow Site Report is provided on the Design Manual Reference and Forms web page at:

<http://www.dot.nd.gov/manuals/design/designmanual/reference-forms.htm>

This spreadsheet is used to track how the requirements for borrow are being met. The order of preference is state option, contractor furnished with clue, and contractor furnished. Once the Borrow Site Report is complete, it is distributed to the Right of Way Program Manager, Designer, and Materials & Research as shown on the flow chart for the borrow process.

#### III-04.02.01 Department Optioned Borrow

For Department Optioned Borrow, the plans shall include bid items for topsoil, seeding, and erosion control for the borrow areas. The following procedures should be followed for Department Optioned Borrow on internal developed projects:

1. The designer determines the estimated quantity of borrow required, forwards the quantity to Right of Way Services Program Manager in ETS, and enters the milestone date for (BOR).
2. Right of Way Services will locate/negotiate borrow sites and complete SFN 10132 Borrow Option.
3. Right of Way Services will submit SFN 58466 Material Source Clearance Request Form. The Material Source Clearance Request Form can be found on the web at: <http://www.dot.nd.gov/business/contractorinfo.htm>.

4. ETS Division will send the Certificate of Approval (COA) link to the designer and the Right of Way Agent.
5. The designer shall complete SFN 9683 Borrow Area List, and attach the COA to SFN 9683. The COA needs to be converted from color to black & white.
6. The designer shall submit the electronic file (Borrow Area List and COA) to the O:\81 Special Projects\DIP PLANS in the appropriate bid opening folder.

The following procedures should be followed for Department Optioned Borrow on consultant projects:

1. The consultant determines the estimated quantity of borrow required, forwards the quantity to the Technical Support Person, and the Technical Support Person enters the milestone date for (BOR).
2. The consultant will locate/negotiate borrow sites and complete SFN 10132 Borrow Option. The consultant shall submit completed SFN 10132 to the Technical Support Person. The Technical Support Person shall submit to Right of Way Services (ETS) for review and approval.
3. The consultant will submit SFN 58466 Material Source Clearance Request Form. The Material Source Clearance Request Form can be found on the web at: <http://www.dot.nd.gov/business/contractorinfo.htm>.
4. ETS Division will send the Certificate of Approval (COA) link to the consultant and copy the Technical Support Person.
5. The consultant shall complete SFN 9683 Borrow Area List, and attach the COA to SFN 9683. The COA needs to be converted from color to black & white.
6. The consultant shall send the electronic file (Borrow Area List and COA) to the Technical Support Person. The Technical Support Person shall submit the electronic file to the O:\81 Special Projects\DIP PLANS in the appropriate bid opening folder.

#### **III-04.02.02 Contractor Furnished Borrow**

For Contractor Furnished Borrow, the contractor will be responsible for all royalty and restoration negotiations and agreements with the landowner. No department negotiated agreements will be provided. The contractor will also be responsible for all environmental/cultural surveys and clearances, permits, and erosion control for the borrow area. If Contractor Furnished Borrow is used, the only bid item required within the plans will be “Borrow-Excavation” and a plan note shall indicate that the Contractor must furnish the borrow material. The topsoil, seeding, and erosion control for the borrow areas shall be included in the price bid for borrow.

There may be circumstances where borrow area clues may be additionally provided to the contractor for Contractor Furnished Borrow. Borrow area clues are intended to aid the contractor in finding borrow area locations for Contractor Furnished Borrow. Examples of potential borrow area clues are information of any previously contacted or logical adjacent property owners for borrow areas, and any completed or partially completed cultural surveys, environmental surveys, or permits. A plan note shall be included to inform the contractor of any available clue information.

**III-04.03 Waste**

Most grading projects are designed with the intent to minimize the excess excavation, and in some cases can achieve an earthwork quantity balance for the material and eliminate any excess excavation. However, some projects may have excess material. There may be projects with a small quantity of unsuitable grading material designated for waste, or excess excavation within the projects limits. Some projects may have a large quantity of excess excavation due to unavoidable circumstances such as terrain or nature of the project such as slide repair projects.

**III-04.03.01 Contractor Furnished Waste Area**

For a Contractor Furnished Waste Area, similar to Contractor Furnished Borrow, the contractor will be responsible for all royalty and restoration negotiations and agreements with the landowner of the waste area. No department negotiated agreements will be provided. The contractor will also be responsible for all environmental/cultural surveys and clearances, permits, and erosion control for the waste area.

There may be circumstances where waste area clues may be additionally provided to the contractor for Contractor Furnished Waste Areas. Waste area clues are intended to aid the contractor in finding waste area locations for Contractor Furnished Waste Areas. Examples of potential waste area clues are information of any previously contacted or logical adjacent property owners for waste areas, and any completed or partially completed cultural surveys, environmental surveys, or permits. A plan note shall be included to inform the contractor of any available clue information.

**III-04.03.02 Department Optioned Waste Area**

It is recommended to locate a State Optioned waste area for projects with large quantities of excess excavation. For Department Optioned Waste Areas, the plans shall include bid items for topsoil, seeding, and erosion control for the borrow areas. The following procedures should be followed for Department Optioned Waste Areas on internal developed projects:

1. The designer determines the estimated quantity of borrow required, forwards the quantity to Right of Way Services Program Manager in ETS, and enters the milestone date for (BOR) and notes the quantity of waste designated within the comments area.
2. Right of Way Services will locate/negotiate waste area sites and complete agreement documents.
3. Right of Way Services will submit SFN 58466 Material Source Clearance Request Form. The Material Source Clearance Request Form can be found on the web at: <http://www.dot.nd.gov/business/contractorinfo.htm>.
4. ETS Division will send the Certificate of Approval (COA) link to the designer and the Right of Way Agent.
5. The designer shall complete the waste area list document, and attach the COA to waste area document. The COA needs to be converted from color to black & white.
6. The designer shall submit the electronic file (waste area list and COA) to the O:\81 Special Projects\DIP PLANS in the appropriate bid opening folder.



The following procedures should be followed for Department Optioned Waste Area on consultant projects:

1. The consultant determines the estimated quantity of waste required, forwards the quantity to the Technical Support Person whom enters the milestone date for (BOR) and notes the quantity of waste designated within the comments area. The Technical Support Person will also forward the waste area agreement documents from ETS Division to the consultant.
2. The consultant will locate/negotiate waste sites and complete waste area agreement documents. The consultant shall submit completed waste area agreement documents to the Technical Support Person. The Technical Support Person shall submit to Right of Way Services (ETS) for review and approval.
3. The consultant will submit SFN 58466 Material Source Clearance Request Form. The Material Source Clearance Request Form can be found on the web at: <http://www.dot.nd.gov/business/contractorinfo.htm>.
4. ETS Division will send the Certificate of Approval (COA) link to the consultant and copy the Technical Support Person.
5. The consultant shall complete waste area list document (forwarded by the Technical Support Person), and attach the COA to the waste area document. The COA needs to be converted from color to black & white.
6. The consultant shall send the electronic file (waste area list document and COA) to the Technical Support Person. The Technical Support Person shall submit the electronic file to the O:\81 Special Projects\DIP PLANS in the appropriate bid opening folder.

If a mandatory waste site is proposed, a public interest finding must be prepared.

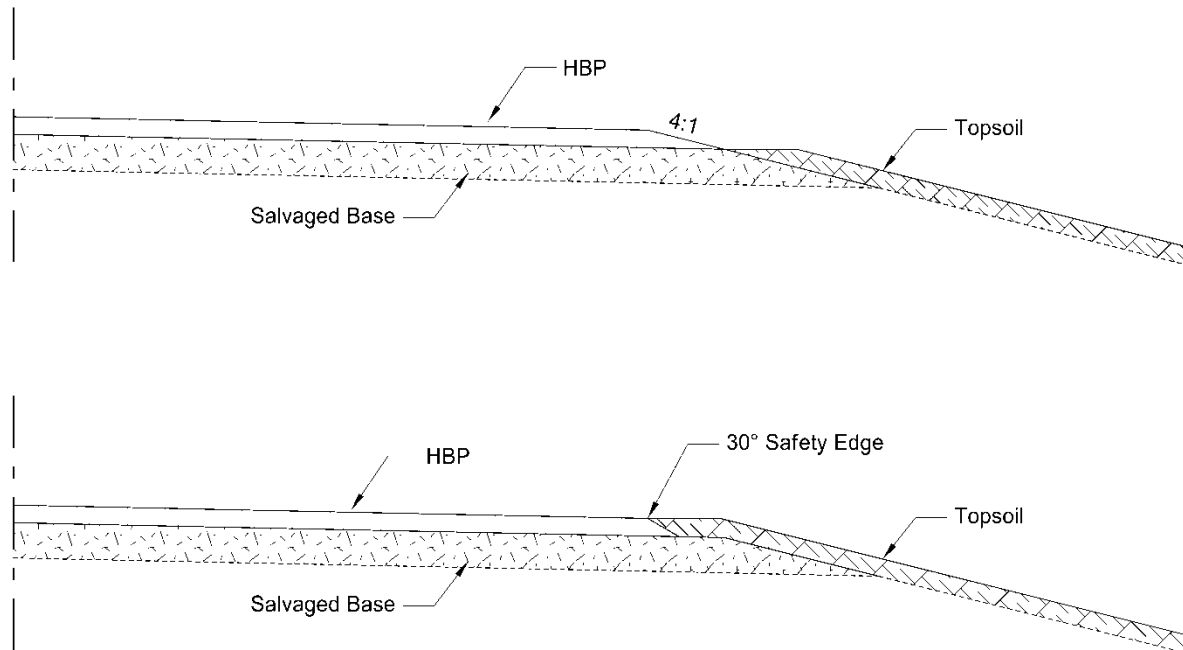
#### **III-04.04 Haul (rural grading)**

Try to keep the haul distances as short as practicable. Calculate the average haul for the total project. For calculation guidance, see the information on the web at: <http://www.dot.nd.gov/manuals/design/caddmanual/caddmanual-welcome.htm> under “Procedures for Calculating Final Earthwork Quantities”

A mass diagram shall be developed and shown within the plans for grading projects. Earthwork end area tables shall also be shown in the plans for grading projects.

#### **III-04.05 Topsoil**

For most projects, the existing topsoil is to be removed, stockpiled, and then spread over the disturbed area, except the roadbed. Some projects may have circumstances or restraints where the existing topsoil cannot be used or only partially used, and may need to use imported topsoil. The plans should have separate bid items for topsoil and imported topsoil (if needed). The plans shall have the thickness of topsoil shown within the Basis of Estimate of the plans. For most projects, 6” of topsoil is the standard depth typically shown within the plans. The District should be consulted during project development to determine the appropriate topsoil depth to use within the plans for topsoil thickness.



At a minimum, a slope staking report showing the break points and tie points to the top of the topsoil shall be developed and provided to the field engineer. When ditch profile elevations are shown in the plans, the elevations shall be to the top of the topsoil.

Cross sections should show the existing topsoil so that the areas of excavation, embankment, topsoil, etc. can be verified.

### III-04.06 Clearing and Grubbing

Generally, this includes the removal and disposal of trees, shrubs, stumps, roots, brush and other surface objects from the excavation and embankment areas. Include bid items within the plans whenever this type of work is needed.

### III-04.07 Compaction

See Standard Specifications for details concerning embankment compaction items. The recommendations for the mainline are provided by the Materials and Research Division.

Generally, AASHTO T-180 is used for compaction; however, AASHTO T-99 is used in the Red River Valley where the engineering properties of the soil indicate that the soil would benefit from a lower maximum dry density and a higher moisture content range.

A volume adjustment percentage should be included for shrinkage in earth embankment within the plans. This is typically shown within the Earthwork Summary plan sheet and also stated within a plan note, which is available on the PPG website. The designer should consult with the District to determine an appropriate volume adjustment percentage for the project area.

### **III-04.08 Seeding and Erosion Control**

Erosion control shall be performed for all projects as needed to enhance soil stabilization and minimize siltation and sedimentation. Typically, this is done through the use of fiber rolls, erosion control mats, silt fences, ditch checks, mulching, seeding, hydro-seeding, sod, and riprap.

Wetlands and mitigation are shown in Section 75 of the plans, temporary erosion control layouts are shown in Section 76 of the plans, and permanent erosions control layouts are in Section 77 of the plans. See the CADD manual for detailed requirements for these sections of the plans.

The designer should consult with the Hydraulic Section in the Bridge Division, ETS Division, and the Erosion and Sediment Control Handbook to develop sedimentation control for all projects. The most recent version of the Erosion and Sediment Control Handbook is on the web at: <http://www.dot.nd.gov/manuals/manuals-publications.htm>

### **III-04.09 Engineering Fabrics**

The use of engineering fabrics such as Geosynthetic Type R1 and Geogrid should be addressed in the Materials and Research Linear Soil Survey Report or any other pertinent recommendation.

### **III-04.10 Widening**

When the roadway is not wide enough to place the proposed improvement that meets the respective minimum roadway width from the *DESIGN GUIDELINES*, it may have to be widened. Generally this means widening on both sides, but there may be circumstances where it would be best to shift the centerline and widen on only one side.

A project is designated as widening when the overall roadway corridor within the scope of the project is to be widened with grading. Widening is typically done with either Major Rehabilitation or New/Reconstruction type projects.

Structural Improvement type projects that address isolated grading areas such as adding turn lanes, flattening approaches, or to correct geometric curvatures are not considered widening projects, as the overall corridor is not widened.

**III-04.10.01 Minor Rehabilitation (Grade Widening)**

Grade Widening is defined as minor grading required to correct foreslope, or re-establish the original traveled-way-plus-shoulders width. Where re-establishing the original traveled-way-plus-shoulders width is triggered to accommodate an overlay, Minor Rehabilitation may include: up to 2' of widening on each side of the roadway or widening to provide 12' driving lanes with 2' shoulders on each side of narrow roadways, even if the total resulting width exceeds the original roadway width. Grade Widening is required to provide 4:1 foreslopes or flatter within the clear zone, and the installation of rumble strips.

Examples of Grade Widening are shown in the Department Shoulder/Slough Guidelines within the *DESIGN GUIDELINES*.

- Foreslopes
  - Minor Rehabilitation Grade Widening projects require 4:1 proposed foreslopes or flatter within 20 feet of the driving lane. This only applies when grade widening foreslopes. All other items for the project will utilize the Minor Rehabilitation clear zone within the *DESIGN GUIDELINES*.
- Signing
  - When existing signs are affected within the limits of grading:
    - The sign will be reset depending on age (less than 7 years old) and condition, otherwise it will be replaced (7 years or older).
    - The post will be reset depending on length, otherwise it will be replaced.
  - Signs outside the limits of grading would be treated per the *DESIGN GUIDELINES* for Minor Rehabilitation strategy.

### III-04.11 Hydraulic Requirements for Approach and Centerline Culverts

A “stream crossing structure” is defined as a pipe, culvert, box culvert, and structural plate pipe. All new stream crossing structures must be sized to meet the requirements of Article 89-14 “Public Highway Stream Crossings” (Stream Crossings Standards) as defined in North Dakota State Administrative Code. Existing stream crossing structures that are replaced or relocated must also be sized to ensure compliance with the Stream Crossing Standards.

Therefore, according to Article 89-14, hydraulic analysis must be completed for stream crossings on projects, regardless of investment strategy, that:

*“...regrade, add a lane adjacent to the existing alignment, or do full depth road surface replacement on an existing highway location.”*

These work activities are further defined by the NDDOT as follows:

- *“regrade”*
  - Means to remove the existing pavement and base section and alter the subgrade profile.
- *“add a lane adjacent to the existing alignment”*
  - Means to add a continuous adjacent through lane to the entire facility. This does not mean adding incremental auxiliary lanes to the facility such as turn lanes, climbing lanes, and passing lanes.
- *“full depth road surface replacement”*
  - Means to completely remove the existing pavement and base down to the subgrade. This does not mean reclaiming the surfacing and base in place.

Therefore, all stream crossing structures will be hydraulically analyzed to ensure they conform to the requirements of the Stream Crossing Standards for all New/Reconstruction investment strategy type projects. However, stream crossings will also need to be hydraulically analyzed on other investment strategy type projects if the activity occurring at the stream crossing includes any of the work activities defined above.

-Examples of when hydraulic analysis would need to be completed are as follows:

- When constructing a new roadway
- Reconstructing a roadway
- Removing pavement and base section above an existing pipe (whether extending or not)
- Subcutting or regrading above an existing pipe (whether extending or not)
- Removing and relaying pipe at the same location. This does not apply when removing and relaying segments of pipe that are beyond the limits of the pavement and base section.
- Relocating pipe

It is recognized that at times, under investment strategies other than New/Reconstruction, it may be prudent to address a failed stream crossing structure. A failed stream crossing structure is defined as a stream crossing structure that:

- has lost capacity due to deformation

- is experiencing significant section loss due to severe corrosion
- is separated (concrete pipe) to the point that a significant amount of embankment material has been scoured out resulting in voids that are causing either holes to form in the paved surface or significant settlement of the area over the pipe.

Under this scenario, the request to perform stream crossing work must be initiated at the time of Scoping, but not later than at the project Field Review. If extenuating circumstances exist, this time period may be extended. Other than lengthening of stream crossing structures (extensions) due to widening or flattening inslopes, the Director of Project Development must approve any stream crossing work on a project that is not within the New/Reconstruction investment strategy and does not fall into one of the work activities as defined above.

If approval is granted to address a stream crossing on a project, all rehabilitation options must be identified and evaluated to determine the most cost effective strategy. All rehabilitation options must be exhausted before a replacement strategy can be considered. If it is determined that lining a stream crossing structure is the appropriate rehabilitation strategy, a hydraulic analysis is only required if:

1. The stream crossing structure's diameter is 48 inches or less and the thickness of the lining is greater than one half inch.
2. The stream crossing structure's diameter is greater than 48 inches and the thickness of the lining is greater than one inch.

If rehabilitation is not a feasible strategy and replacement of the failed stream crossing is required, a hydraulic analysis will be performed to determine the opening size and to assure that the Stream Crossing Standards are being met.

### III-04.11.01 New/Reconstruction Culvert Replacement

All existing culverts need to be hydraulically analyzed for compliance with stream crossing standards.

- Approach pipes
  - All approach pipes should be replaced.
- Centerline Pipes
  - Existing centerline pipes should be considered for replacement if they have been in place for 50 years or longer.
  - All existing centerline pipes and end sections should have a condition survey done.
  - Existing centerline pipes or end sections in poor condition should be replaced or rehabilitated by other means such as pipe lining.
  - If the pipes and/or end sections are in good condition and have sufficient strength for the proposed fills, the centerline pipes and end sections should be re-laid and/or extended.
  - Traversable end sections may be used if applicable.
  - Any existing centerline pipes removed within the project that are in good condition can be used for new culvert installations if they have sufficient strength for the proposed fills. If not, they may be able to be used for extensions under the foreslope where the fill height is less and within the strength limitation of the old sections.
- Structural Plate Pipe
  - The Bridge Preliminary Concept will recommend proposed improvements for existing structural plate pipes that have an associated Bridge Listing #. Structural plate pipes that do not have a Bridge Listing # will be treated as centerline pipes above.
- Box Culverts
  - The Bridge Preliminary Concept will recommend proposed improvements.
- Cattle Pass
  - The designer shall determine whether the existing cattle pass structure is being used for drainage, see centerline pipes above.
  - See Section 2.23 of the Right of Way Manual for information regarding cattle pass policies.

### III-04.11.02 Major Rehabilitation Culvert Replacement

Culverts shall be extended or made traversable as recommended within the Major Rehabilitation Safety Review. Use the applicable Clear Zone for *DESIGN GUIDELINES* Major Rehabilitation.

Existing culverts will not be hydraulically analyzed on these projects unless work activities, as defined under III-04.11, are being performed at the pipe location or a failed stream crossing has been identified for rehabilitation or replacement (*Only approved culvert replacements and particular pipe liners as outlined in Section III-04.11 will be hydraulically analyzed*)

- Approach pipes
  - Approach pipes affected by the grading should be extended if not failed. Need approval for any other stream crossing work as outlined in Section III-04.11.
  - Relay end sections or provide new end sections as applicable.
- Centerline pipes
  - Centerline pipes affected by the grading of the project should be extended if not failed. Need approval for any other stream crossing work as outlined in Section III-04.11.
  - Relay end sections or provide new end sections as applicable.
- Structural Plate Pipe
  - The Bridge Preliminary Concept will recommend proposed improvements for existing structural plate pipes that have an associated Bridge Listing #. Structural plate pipes that do not have a Bridge Listing # will be treated as centerline pipes above.
- Box Culverts
  - The Bridge Preliminary Concept will recommend proposed improvements. Engineering justification and the Bridge Division Engineer approval is required to extend any box culvert beyond the *DESIGN GUIDELINES* Major Rehabilitation Clear Zone.
- Cattle Pass
  - The designer shall determine whether the existing cattle pass structure is being used for drainage, see centerline pipes above.
  - See Section 2.23 of the Right of Way Manual for information regarding cattle pass policies.



### III-04.11.03 Structural Improvement Culvert Replacement

Culverts shall be extended or made traversable as recommended within the Structural Improvement Safety Review. Use the applicable Clear Zone for *DESIGN GUIDELINES* Structural Improvement.

Existing culverts will not be hydraulically analyzed on these projects unless work activities, as defined under III-04.11, are being performed at the pipe location or a failed stream crossing has been identified for rehabilitation or replacement. (*Only approved culvert replacements and particular pipe liners as outlined in Section III-04.11 will be hydraulically analyzed*)

- Approach pipes
  - Approach pipes affected by the grading should be extended if not failed. Need approval for any other stream crossing work as outlined in Section III-04.11.
  - Relay end sections or provide new end sections as applicable.
- Centerline pipes
  - Centerline pipes affected by the grading of the project should be extended if not failed. Need approval for any other stream crossing work as outlined in Section III-04.11.
  - Relay end sections or provide new end sections as applicable.
- Structural Plate Pipe
  - The Bridge Preliminary Concept will recommend proposed improvements for existing structural plate pipes that have an associated Bridge Listing #. Structural plate pipes that do not have a Bridge Listing # will be treated as centerline pipes above.
- Box Culverts
  - The Bridge Preliminary Concept will recommend proposed improvements. Engineering justification and the Bridge Division Engineer approval is required to extend any box culvert beyond the *DESIGN GUIDELINES* Structural Improvement Clear Zone.
- Cattle Pass
  - The designer shall determine whether the existing cattle pass structure is being used for drainage, see centerline pipes above.
  - See Section 2.23 of the Right of Way Manual for information regarding cattle pass policies.

**III-04.11.04 Minor Rehabilitation (Grade Widening) Culvert Replacement**

Culverts should be extended to the limits of the proposed grade widening.

Existing culverts will not be hydraulically analyzed on these projects unless work activities, as defined under III-04.11, are being performed at the pipe location or a failed stream crossing has been identified for rehabilitation or replacement. *(Only approved culvert replacements and particular pipe liners as outlined in Section III-04.11 will be hydraulically analyzed)*

- Approach pipes *(Generally, grade widening projects will not affect the existing approach pipes and will not be addressed within the scope of the project)*
  - Approach pipes affected by the grading should be extended if not failed. Need approval for any other stream crossing work as outlined in Section III-04.11.
  - Relay end sections or provide new end sections as applicable.
- Centerline pipes
  - Centerline pipes affected by the grading of the project should be extended if not failed. Need approval for any other stream crossing work as outlined in Section III-04.11.
  - Pipe extensions will be limited to that required for the extent of grade widening only, or to accommodate a standard pipe increment length, whichever is greater.
  - Relay the existing end sections. If the existing end section needs to be replaced, the end section may then be replaced with a traversable or flared end section.
- Structural Plate Pipe
  - Structural plate pipe should only be extended enough to accommodate grade widening only.
- Box Culverts
  - Box culvert extensions are only needed if the proposed foreslope results in a slope that is steeper than 4:1 through the limits of the box culvert.
  - The Bridge Preliminary Concept will recommend proposed improvements. Engineering justification and the Bridge Division Engineer approval is required to extend any box culvert beyond the limits of the proposed grade widening.
- Cattle Pass
  - Cattle passes should only be extended enough to accommodate grade widening only.
  - The designer shall determine whether the existing cattle pass structure is being used for drainage.
  - See Section 2.23 of the Right of Way Manual for information regarding cattle pass policies.

### III-04.12 Grade Raises (Closed Basin)

Grade raise projects through closed basins are generally constructed for roadways with imminent risk of inundation, or roadways that are currently inundated by the adjacent water body or basin.

The grade raise is typically measured from the existing water elevation, unless otherwise specified in the Detailed Damage Inspection Report (DDIR) or in modification agreed to later. The grade raise is measured to the roadway centerline of the proposed subgrade on a tangent section. The grade raise should be: existing water elevation + hydraulic analysis + freeboard\* = centerline of proposed subgrade (see figure III-04.12).

*\*Freeboard will vary with the proposed typical section to accommodate riprap to be placed 2' above the forecasted water elevation and outside the clearzone with no flatter than 10:1 foreslopes. Some basins may require riprap to placed 5' above the forecasted water elevation to accommodate larger wave attenuation such as for Devils Lake.*

Typically, 3 build alternates are proposed within the DCE for a given grade raise project:

1. Grade Raise above the natural outlet elevation
2. 5' Grade Raise above the existing water elevation
3. Grade Raise above the 3-year net storage forecasted water elevation (optional)

A hydraulic study/analysis (see Section V-04.10) should be done for the affected area to determine the natural outlet elevation of the basin, the 3-year net storage forecasted water elevation, and determine the adequate centerline drainage for equalization and stream crossing criteria. The riprap shall be placed 2' above the forecasted water elevation unless the hydraulic report recommends riprap at a higher elevation. The hydraulic study should estimate the time forecasted when the storage of the basin will reach the natural outlet and/or exceed the 5' Grade Raise elevation. Designers can use the forecasted water elevation to determine the grade at the centerline of the proposed subgrade on tangent section.

Generally, the existing centerline culverts should be extended if possible with the use of temporary earthen berms and without the use of engineered cofferdams (historically  $\leq 8$  feet depth of water). If the existing culverts are not extended, new centerline culverts shall be installed to a higher invert.

If circumstances potentially warrant the use of engineered cofferdams for any proposed centerline culverts, a decision item should be included within the Documented Categorical Exclusion (DCE) or other decision document to address this proposed work with the project.

Grade raise projects shall follow design criteria for New/Reconstruction within the *DESIGN GUIDELINES*. Generally, the proposed typical section for rural roadway grade raise projects should incorporate:

- The existing roadway paved surface can remain in place if depth of proposed fill is  $\geq 1'$ .
- 2 volume adjustment percentages should be used for earth embankment:
  - A higher volume adjustment percentage should be included for shrinkage and material loss for earth embankment placed within the water.
  - A lower volume adjustment percentage should also be included for shrinkage for earth embankment not placed in water.
- A minimum foreslope rate of 10:1 within the clearzone to provide adequate drainage.
- The existing foreslope/clearzone should be transitioned to the proposed foreslope/clearzone a distance of  $L_r$  (Runout Length) in advance of the riprap. (See detail on PPG website).
- Riprap placed outside the clearzone at a 3:1 foreslope.
- Riprap placed 2' below the existing water elevation, a minimum of 2' above the design water elevation, and at a 2' thickness/depth.
- A temporary earthen berm for existing water depths 8' or greater. After the riprap has been placed, the earthen berm should be removed to a depth 1' below the existing water elevation. The earthen berm shall be entirely removed at all pipe locations to eliminate potential siltation within the pipe.
- Geosynthetic Material Type RR fabric underneath the riprap along the 3:1 foreslope to the bottom of the riprap. The Type RR fabric shall utilize a key at the top of the riprap. The Type RR fabric shall also utilize a dutch wrap at the bottom of the riprap placement if earthen berms are utilized.
- When a grade raise is on a curve, add centerline rise to the profile. The elevation of the edge of the driving lane should be maintained from the tangent section through the low side of the curve.
- The proposed roadway width shall consist of a minimum 28' paved surface and the additional roadway width required as aggregate surface to meet the minimum roadway width guidelines.
- If the existing roadway paved surface adjacent to the begin/end project limits exceeds 28', the proposed paved surface shall match the existing paved surface and the additional roadway width required as aggregate surface to meet the minimum roadway width guidelines.

\*For example, if the *DESIGN GUIDELINES* for New/Reconstruction requires a 36' minimum roadway width and the existing roadway is 30' paved width, the proposed typical section should be 30' paved surface with additional 3' as aggregate surface on each side to meet the minimum 36' roadway width guidelines.

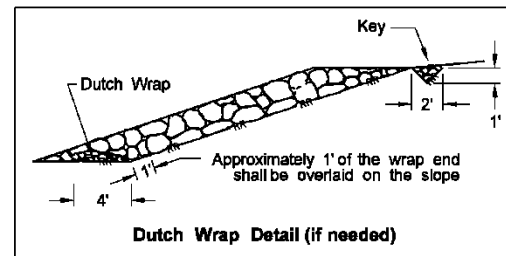
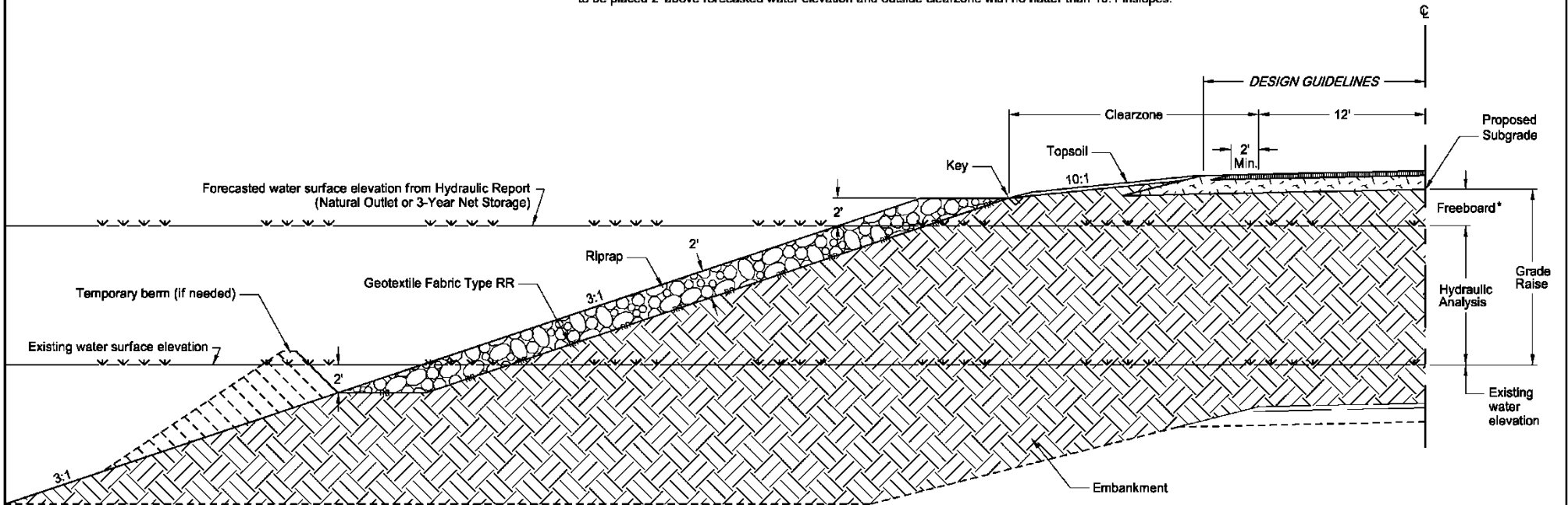
\*See Figure III-03.12.01 and Figure III-03.12.02 Grade Raise on the following pages.

Figure III-04.12.01 Grade Raise

STATE	PROJECT NO.	SECTION NO.	SHEET NO.
ND	project number	sec	page

Grade Raise: existing water elevation + hydraulic analysis + freeboard\* = centerline of proposed subgrade.

\*Freeboard measured to the proposed subgrade  $\phi$  varies with proposed typical section to accommodate riprap to be placed 2' above forecasted water elevation and outside clearzone with no flatter than 10:1 inslopes.



This document is preliminary and not for construction or implementation purposes.

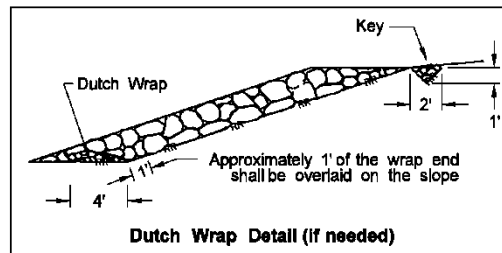
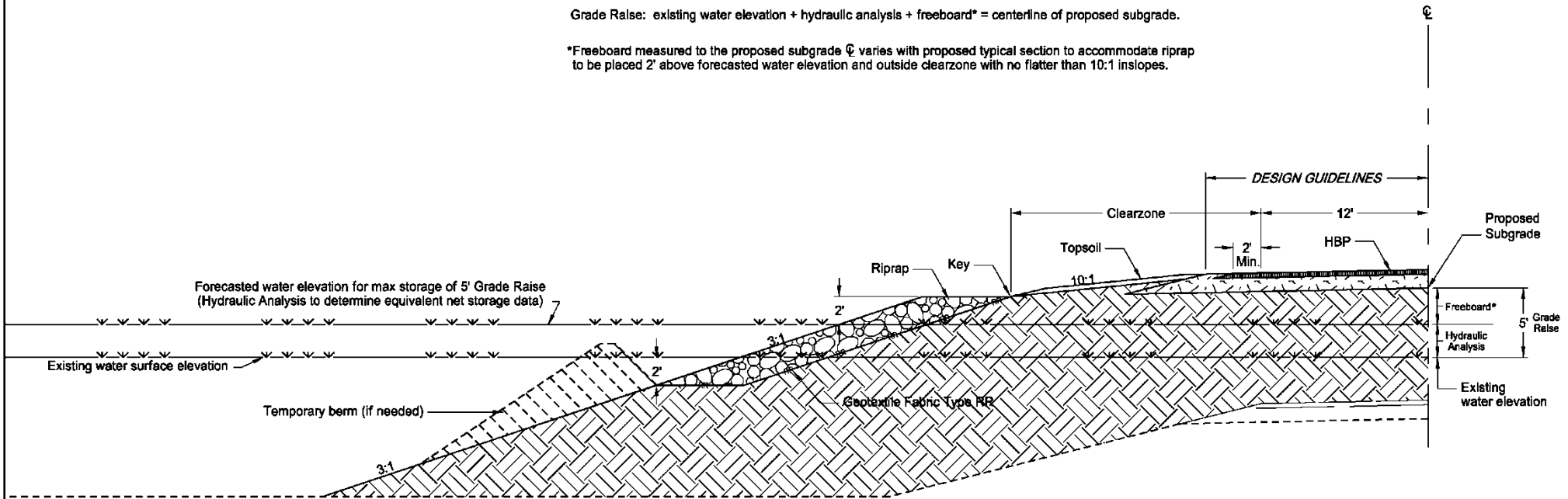
Proposed Grade Raise  
Closed Basin  
Based on Hydraulic Analysis

Figure III-04.12.02 Grade Raise

STATE	PROJECT NO.	SECTION NO.	SHEET NO.
ND	project number	sec	page

Grade Raise: existing water elevation + hydraulic analysis + freeboard\* = centerline of proposed subgrade.

\*Freeboard measured to the proposed subgrade  $\text{C}$  varies with proposed typical section to accommodate riprap to be placed 2' above forecasted water elevation and outside clearzone with no flatter than 10:1 inslopes.



This document is preliminary and not for construction or implementation purposes.

Proposed Grade Raise  
 Closed Basin  
 5' Grade Raise Alternate

**III-05.01 Aggregate Base Course C1 5 and Salvaged Base Course**

The slough of the aggregate base shall not be steeper than 4:1 when placing hot bituminous pavement on base for a new section. Steeper base sloughs may be used for placement of concrete.

Base course provided under the surface course will either consist of totally virgin aggregate (Aggregate Base Course C1 5), or a mixture of virgin aggregate and recycled/removed asphalt, concrete, or aggregate (Salvaged Base Course). The bid item quantity for base course within the plans should generally use TON units.

The decision to use either the Aggregate Base Course C1 5 bid item, or the Salvaged Base Course bid item within the plans should be evaluated by the designer and/or district using the following criteria:

- Salvaged Base Course bid item shall be used if the amount of removed material available from the project results in a total quantity of Salvaged Base Course being  $\geq 50\%$  of the base needed for the proposed project.
- Consequently, if  $< 50\%$  total is generated, then the Aggregate Base Course C1 5 bid item shall be used. Coordinate with the District and allow the use of the bid item Salvaged Base Course as requested.

For example, if a project requires 100,000 TON of proposed base needed to build the project and:

- There are 12,000 TON of existing bituminous removals, which will create a maximum of 40,000 TON of Salvaged Base Course (30% minimum existing bituminous material, Section 817-Spec Book).
- There are also 3,000 TON of existing concrete removals, which will create another 10,000 TON of Salvaged Base Course (30% Minimum existing concrete material, Section 817-Spec Book).
- The total maximum Salvaged Base Course generated is  $40,000 + 10,000 \text{ TON} = \underline{50,000 \text{ TON}}$ .
- The criteria for using the Salvaged Base Course bid item within the plans has been met above because the total 50,000 TON Salvaged Base Course generated is  $\geq 50\%$  of the 100,000 TON of proposed base required for the project.

However, the designer needs to also consider the project phasing and operations when calculating the above criteria. If the project phasing does not provide access to removing existing material for salvaging into proposed base course due to traffic control or operations, the designer needs to adjust their above criteria calculations. Another consideration that needs to be adjusted by the designer above is if the removed bituminous material is to be incorporated into Recycled Asphalt Pavement (RAP).

All assumptions, considerations, and calculations used above shall be displayed within a table on the Basis of Estimate (Section 10) of the plans to clearly summarize the existing and proposed materials for the project.

### III-05.02 Permeable Stabilized Base Course

Permeable base is generally not used on NDDOT projects, and the decision for its use will be evaluated on a case-by-case basis. Materials and Research Division will identify these projects and would provide the recommendation in their report.

Permeable base is an open graded base that allows water to drain through it at a relatively high rate (approx. 1500 ft. per day).

The materials used for permeable base treatment are asphalt or cement. An additional 6" width of permeable base shall be placed on both sides of the mainline pavement for edge drain constructability. The thickness of the base should be given in the Materials and Research Division recommendations. The aggregate and cementitious materials are specified in Section 304 of the Standard Specifications.

### III-05.03 Full Depth Reclamation

Some existing roadways may have surfacing which is so badly deteriorated that an overlay would not be appropriate. Where complete reconstruction is not considered an option, full depth reclamation could be considered.

Generally, full depth reclamation is accomplished by placing virgin aggregate on the existing roadway and then processing the virgin aggregate, surfacing, and possibly the underlying aggregate base material with a reclaimer. The virgin aggregate, existing surfacing and the existing aggregate base are mixed together, in place, to form a blended base. This process is commonly called "Mine and Blend". In some cases, a stabilizing agent is also added to the blended material. These stabilizers can be lime, cement, or asphalt cement; but are typically cement.

The total depth of blending, the thickness and class of virgin aggregate, stabilizing agent, and whether the reclaimer can run on the subgrade or must run on the surfacing, will be as recommended by the Materials and Research Division.

The blending is done on the roadway, or can be accomplished by hauling the materials from the roadway and blending them off site and then hauling the blended base back to the roadway to lay and compact.

### III-05.04 Edge Drains

Edge drains are perforated pipe systems that allow water to enter and be carried to outlets where it is emptied into the highway ditch or storm sewer. Edge drains are placed in trenches that are parallel to the centerline of the roadway and adjacent to the outer edge of concrete. This item should be covered in the Materials and Research recommendations.

Where there is guardrail, locate the drains so they don't conflict with the guardrail posts.



**III-05.05 Prime Coat**

Prime coat is a thin layer of liquid asphalt and is generally placed on a finished base to protect it from the elements and to provide a temporary surface until the final surfacing can be placed. The rate of application may vary, but is normally 0.35 GAL/SY for virgin aggregate and 0.25 GAL/SY for salvaged bituminous material base.

If the primed base will be open to traffic, blotter sand should be provided at the rate of 12 lb/sy (generally).

See the *DESIGN GUIDELINES* in Section I-06 for requirements for cross slope of the roadway.

For New/Reconstruction projects:

- The cross slope of the driving lanes range from 1.5% to 2.5%. Typically, the driving lanes have a cross slope of 2.1%.
- The maximum cross slope on the shoulders is 6%. The cross slope on shoulders for the Interstate is typically 2.9%. As a cost saving measure, the shoulder thickness should be reduced to provide shoulder cross slope.

The Materials and Research Division develops the design for the entire pavement section. Materials and Research Division will only submit a design recommendation if the project investment strategy is a Structural Improvement, Major Rehabilitation, or New/Reconstruction. The design recommendations include:

- Thickness and type of base (dense, blended, or permeable).
- Thickness of surfacing (asphalt and concrete).
- Class of HBP to be used.
- Type and percentage of asphalt cement for asphalt pavements.

When centerline profile elevations are shown in the plans, the elevations shall be to the top of the pavement. If there is an additional surfacing project scheduled for the following year to place the final lifts of pavement, the signing plans should provide adequate vertical clearance so that when the final lift(s) of pavement are placed, the signs will have the correct vertical clearance.

### **III-06.01 Asphalt Pavements**

#### **III-06.01.01 Overlays Greater than Three Inches**

Investment strategies included with asphalt overlays greater than 3 inches are: Structural Improvement, Major Rehabilitation, and New/Reconstruction. Asphalt overlays greater than three inches are intended to extend the useful life of a highway by restoring the pavement structure. The thickness of the overlay is determined by Materials and Research Division.

#### **III-06.01.02 Overlays Three Inches or Less**

Investment strategies included with asphalt overlays 3 inches or less are Preventive Maintenance and Minor Rehabilitation as follows:

- Preventive Maintenance are asphalt overlays 2” maximum thickness. There is no allowance for rut filling on Preventive Maintenance projects (2” max overlay). If rut filling is needed, the quantity should be taken from the overall mainline quantity.
- Minor Rehabilitation are asphalt overlays up to 3” maximum.

These strategies are intended to slow the deterioration of the pavement and improve ride quality. The overlay thickness will be determined by the District Engineer. Materials and Research Division will not submit thickness recommendations for Preventive Maintenance and Minor Rehabilitation strategies.

### **III-06.01.03 Milling**

Milling is a process where some of the surfacing is removed to correct the typical section or make adequate room for an overlay without widening.

### **III-06.01.04 Overlay Transition Tapers**

To reduce the chances of the thin sections (ends of bridges, railroad tracks, ends of the project, away from curbs, etc.) from raveling, the designer should require that the transitions be milled. Paving transitions placed in the late fall may not adhere to the existing pavement surface and this treatment allows for a thickened transition section. A plan note may be used to cover this work requirement. A sample note can be found on the web at: <http://www.dot.nd.gov/manuals/design/designmanual/designmanual.htm> under “Plan Preparation Guide”, “Plan Notes”

Generally, a detail is included in the plan sheets.

### **III-06.01.05 Slough/Shoulder Treatments**

See the appropriate Department Slough/Shoulder Guidelines shown in the *DESIGN GUIDELINES* in Section I-06 of the Design Manual for slough/shoulder treatment method requirements for various project investment strategies.

## **III-06.02 Portland Cement Concrete (PCC) Pavement**

### **III-06.02.01 New/Reconstruction**

This process is used when the PCC has reached a condition where it is no longer cost effective to repair. The surfacing is removed, the subgrade reworked, the roadway may need widening, the vertical and horizontal alignment may need to be changed, and new base and surfacing is placed. The existing surfacing, be it asphalt, PCC, or aggregate, is salvaged and recycled into the base. Generally, salvaged material is not used in the surfacing.

Concrete pavements could be plain jointed with dowels or continuously reinforced. Materials and Research will recommend if continuously reinforced concrete pavement should be used.

### **III-06.02.02 White Topping**

White topping is a Structural Improvement where a layer of PCC is placed over an existing pavement. This can be done as either a bonded or unbonded overlay.

### III-06.02.03 Concrete Pavement Repair (CPR)

This work consists of repairing spalled joints, broken slabs, stitching, installing dowel bars in existing joints to re-establish load transfer, and grinding the surface to improve the ride. There are two strategies for CPR:

- Minor CPR – Preventive Maintenance: Less than 10% of the pavement surface area per mile is repaired.
- Major CPR – Major Rehabilitation: Greater than 10% of the pavement surface area per mile is repaired.

When making repairs to continuously reinforced concrete, the continuity of the reinforcing should be re-established.

### III-06.02.04 Expansion, Contraction, WT Terminal, and Tied Longitudinal Joints

Generally:

- Expansion joints should not be used except at bridges.
- Contraction joints are used on all non-reinforced concrete pavements.
- The maximum width of concrete that is tied together is 40 feet.
- Terminal joints are used where continuously reinforced concrete pavement abuts non-reinforced concrete pavement or a bridge.

### III-06.03 Driveway and Guardrail Surfacing Policy

The following driveway and guardrail surfacing policy applies to paving projects, and does not apply to seal coats and microsurfacing projects.

#### III-06.03.01 Rural Projects

Generally, the following will govern the surfacing of driveways and under guardrail. There may be exceptions that can be handled on a case-by-case basis:

- For Structural Improvement, Major Rehabilitation, or New/Reconstruction projects:
  - Pave to the ROW for paved section lines, paved county roads, paved street approaches, or paved private drives.
  - Pave to the radius for gravel section lines, gravel county roads, gravel street approaches, and gravel private drives.
  - Pave a 5' area of pavement from the edge of driving lane to provide a transition into field drive approaches.

- For Preventive Maintenance and Minor Rehabilitation projects:
  - Pave to the ROW for paved section lines, paved county roads, or paved street approaches.
  - Pave a 5' area of pavement from the edge of driving lane to provide a transition into gravel section lines, gravel county roads, gravel street approaches, paved private drives, gravel private drives, or field drive approaches.
- If the drive was previously paved and is disturbed during the construction, it will be paved.
- Surfacing is to be provided under guardrail to a point 3 feet beyond the back of the face of the guardrail.

### III-06.03.02 Urban Projects

- Generally, the driveway will be paved to the R/W line or to the limit of the construction easement that is needed to blend the drive into the adjacent property or connect with existing surfacing.
- The design used for driveways should be the same as the respective cities use. Driveways may need to be thickened or reinforced in industrial areas.

### III-06.04 Shoulder Surfacing

Generally, the following guidelines will be utilized when selecting to pave shoulders:

- Interstate System
  - Median and outside shoulders are paved, structurally sound.
- Interregional System
  - The shoulders of an Interregional segment that has more than 2,000 ADT should be paved. For Interregional segments with less than 2,000 ADT, use a 28' paved roadway width and gravel shoulders. On four-lane facilities, the paved roadway width would include the inside shoulder.
  - If the guideline for shoulder type results in short segments of an Interregional Corridor having gravel shoulders and the remaining portions of the corridor within the logical termini (major roadway to a city or another major roadway) are paved, the Environmental Document should present shoulder treatment options and not rely solely on the traffic guidelines.
  - The shoulders on the Interregional system roadways that are designated as Congressional High Priority Corridors should be paved. The corridors with this designation in North Dakota are: US Highway 85 from the South Dakota border to Williston, US Highway 2 from Williston to the Montana border; US Highway 83 from the South Dakota border to the Canadian border, and I-29 from the South Dakota Border to the Canadian Border.

- State Corridor
  - The shoulders of a State Corridor segment that is on the National Highway System (NHS) and has more than 2000 AADT will typically be paved.
  - The shoulders on State Corridor segments off the NHS, or NHS segments with less than 2000 AADT will typically be aggregate.
- District Corridor
  - The shoulders of a District Corridor segment that is on the National Highway System (NHS) and has more than 2000 ADT will typically be paved.
  - The shoulders on District Corridor segments off the NHS, or NHS segments with less than 2000 ADT will typically be aggregate.
- District Collector
  - Shoulders are aggregate.

### III-06.05 Rumble Strips

The purpose of rumble strips is to save lives by reducing head-on and run off the road (ROR) crashes. Rumble strips are used to effectively reduce shallow angle ROR crashes. These types of crashes are usually caused by distracted, drowsy, or fatigued driving. The noise and vibrations caused by driving on rumble strips alert the driver of a near lane departure, allowing time to make corrections. Rumble strips are not effective for ROR crashes caused by excessive speed, loss of control, sudden turns to avoid on-road collisions, high-angle encroachments.

Rumble strips will be installed in conjunction with rural highway projects where paved shoulders are constructed, reconstructed, or overlaid as part of a highway construction contract.

Rumble strips will not be installed across bridge decks and approach slabs, adjacent to guardrail, and ½ mile on either side of:

- Highways with posted speeds 45 mph or less
- All urban areas\*
- Areas with curb and gutter

\*Urban areas are areas within city limits, or reduced speed zones near towns and cities.

#### III-06.05.01 Bicycle Travel Considerations

The shoulder and edgeline rumble strip pattern for undivided roadways with shoulders 1' or greater in width shall provide an intermittent pattern of 40' length of rumble strips with 10' gaps of no rumble strips to accommodate bicycle maneuvers from one side of the rumble strips to the other without having to encounter the indentations/grooves.

If the roadway is identified on the United States Bicycle Route System (USBRS), an executive decision for the installation of rumble strips will be determined during the Environmental Documentation process.

**III-06.05.02 Maintenance Considerations**

Rumble strips must be reinstalled if covered during patching and overlay activities.

The rumble strips may be covered during chip and sand sealing activities. The District Engineer may limit chips to the travel lanes only and sand the shoulders, or eliminate the chips or sand on the shoulders altogether.

**III-06.05.03 Installation**

Installations for rumble strips include shoulder rumble strips, edgeline rumble strips, centerline rumble strips, and saw slotted rumble strips at intersections. Installations for rumble strips are shown for various roadway types on the following Standard Drawings:

- Standard Drawing D-760-1  
RUMBLE STRIPS INTERSTATE HIGHWAYS
- Standard Drawing D-760-2  
RUMBLE STRIPS DIVIDED HIGHWAYS (NON-INTERSTATE)
- Standard Drawing D-760-3  
RUMBLE STRIPS UNDIVIDED HIGHWAYS (SHOULDERS 4' OR GREATER)
- Standard Drawing D-760-4  
RUMBLE STRIPS UNDIVIDED HIGHWAYS (SHOULDERS LESS THAN 4')
- Standard Drawing D-760-5  
SAW SLOTTED RUMBLE STRIPS AT INTERSECTIONS

Shoulder rumble strips may also be installed on the right shoulder of Interstate loop ramps.

Section 217 of Title 23 of the United States Code encourages the development and improvement of pedestrian walkways and bicycle transportation.

Section 217 (I) of Title 23 provides that no bicycle project may be carried out under this section unless it is determined that such project will be principally for transportation, rather than recreation purposes.

Section 217 (g) of Title 23 provides, in general, that bicyclists and pedestrians shall be given due consideration in the comprehensive transportation plans developed by each metropolitan planning organization and state. It further provides that bicycle transportation facilities and pedestrian walkways shall be considered, where appropriate, in conjunction with all new construction and reconstruction of transportation facilities, except where bicycle and pedestrian use are not permitted.

Section 217 refers to the Design Guidance called for in Section 1202 of Public Law 105-178 (TEA 21) which identified issues that are to be addressed as follows:

- Level and nature of the demand.
- Volume and speed of motor vehicle traffic
- Safety
- Terrain
- Cost
- Sight distance

### **III-07.01 Pedestrian Facilities (Sidewalks)**

- The need for sidewalks shall be considered on new or reconstructed projects.
- The sidewalks must meet accessibility guidelines.
- When constructing a bridge, sidewalks shall be considered.
- If a sidewalk is placed on the bridge, a canopy over the sidewalk should be considered.
- Separated crossings should be considered where the pedestrian volume, traffic volume and intersection capacity favor their use. The Traffic Operations Report will normally recommend it if warranted.
- For design details for sidewalks refer to Standard Drawing D-750-2.
- If the city already uses reinforcing steel in their sidewalks, it may be installed as a project cost. A plan note should state that the cost of the reinforcing steel should be included in the price bid for the cost of the sidewalk concrete. A detail drawing or plan note should be included in the plans to show the spacing of the reinforcing steel.
- Where a highway abuts or enters a town, curb ramps should be installed or the existing ramps upgraded through the business district.



- Where the highway is on the Urban Regional System, the City should include curb ramps at all intersections where sidewalk is present and update existing curb ramps to current ADA requirements. See Standard Drawing D-750-3.
- For design details, refer to AASHTO's "Guide for the Planning, Design, and Operation of Pedestrian Facilities."

### **III-07.02 Bicycle Facilities**

- The need for bicycle transportation facilities shall be considered on new or reconstructed projects.
- Bicycle facilities could be stand alone projects.
- When considering a bike facility, it should be consistent with the respective city's bike plan, if they have one.
- The bicycle facilities could be located on the roadway.
- The bicycle facility could be a separate facility located away from the roadway.
- This lane could be a shared path, which would allow bicyclists, pedestrians, wheelchair users, in-line and roller skaters, etc. to use the facility.
- The separate bicycle facility must meet accessibility guidelines.
- For design details, refer to AASHTO'S "A Guide for The Development of Bicycle Facilities."
- If the city already uses reinforcing steel in their bikeways, it may be installed as a part of the project. A plan note should state that the cost of the reinforcing steel should be included in the price bid for the cost of the bikeway concrete. A detail drawing or plan note should be included in the plans to show the spacing of the reinforcing steel.

### **III-07.03 Concrete Paving Colored with Brick Pattern**

If the city already uses reinforcing steel in their brick patterned colored concrete, it may be installed as a part of the project. A plan note should state that the cost of the reinforcing steel should be included in the price bid for the cost of the brick patterned colored concrete. A detail drawing or plan note should be included in the plans to show the spacing of the reinforcing steel.

**III-07.04 ADAAG Detectable Warnings (Truncated Domes)**

Truncated domes are the standard design requirement for detectable warnings for determining the boundary between the sidewalk and street by visually impaired people. They have a unique design that can be detected underfoot and with a cane. Truncated domes are the only detectable warnings allowed by the Americans with Disabilities Act Accessibility Guidelines (ADAAG). Grooves, exposed aggregate and other designs intended for use as detectable warnings are too similar to pavement textures, cracks, and joints.

To comply with the American with Disabilities Act (ADA), all state and local agencies are required to utilize truncated domes on new and existing curb ramps, as follows:

1. Types of work that are considered to be new construction or reconstruction projects:<sup>1</sup>
  - Grade and Surfacing
  - Structures: new, replacement and rehabilitation
  - Widening or realignment or a roadway/shoulders
  - Traffic Control Devices: Signalization
  - Rest Area projects
2. Major and Minor Rehabilitation and Structural Improvement Projects such as:
  - Bituminous or concrete overlays and/or milling projects that improve the structural components of the roadway (greater than 2 inches overlay, excluding rut filling).
  - Major Concrete Pavement Repair/Dowel Bar Retrofit
  - Intersection improvements: adding turn lanes
  - Safety improvements and/or enhancements
3. Preventive Maintenance projects such as:
  - Overlays less than 2 inches
  - Minor Concrete Pavement Repair (less than 10% of the pavement surface area per mile)
4. All projects where constructing or altering curb ramps or otherwise affecting the mobility of pedestrians.

Some Preventive Maintenance Projects; such as crack sealing and re-striping, do not require modifications of curb ramps and/or truncated domes.

---

<sup>1</sup> Department of Justice Joint Final Rule on Detectable warnings and suspensions, Nov. 1998.  
<http://www.access-board.gov> pick Publications, under Facilities pick Detectable Warnings: Final Rule.

**Specifications:<sup>2</sup>**

Dome Alignment – Domes shall be aligned on a square grid in the predominant direction of travel.

Size – Detectable warning surfaces shall extend 24 inches in the direction of travel and the full width of the curb ramp landing.

Location (see Standard Drawing D-750-3):

1. Curb Ramps and Blended Transitions: The detectable warning surface shall be located so that the nearest edge is 6” minimum and 8” maximum from the face of the curb.
2. Median and Pedestrian Refuge Islands: Medians and refuge islands shall have detectable warnings. Detectable warnings at cut-through islands shall be separated by 24-in minimum length of walkway without detectable warnings. Exceptions: Detectable warnings shall not be required on cut-through islands where the crossing is controlled by signals and is timed for full crossing.
3. Railroad Crossing: Detectable warning surfaces shall be located at the outside of each group of tracks that cross a pedestrian access route. The detectable warning surface shall be located so that the edge nearest the rail crossing is 6’ minimum and 8’ maximum from the vehicle dynamic envelope (the clearance required for a rail vehicle and its cargo overhand due to any combination of lading, lateral motion, or suspension failure). Where the pedestrian access route crosses the rail system at grade, the surface of the pedestrian access route shall be level and flush with the top of the rail at the outer edge and between rails.

---

<sup>2</sup>Guidelines for Accessible Public Rights of Way, <http://www.access-board.gov> pick Publications, under Public Right of Way pick Building a True Community: Accessible Public Rights of Way, pick Part III.

### **III-08.01 General**

These guidelines apply to all public and private utilities, including, but not limited to, electric power, communications, cable television, water, gas, oil, slurry, petroleum products, steam, sanitary sewers, wireless facilities (towers), drainage, irrigation, and similar facilities that are to be located, adjusted, or relocated within any NDDOT right of way.

The location and design of all utilities within highway right of way must conform to Chapter 23 of the Code of Federal Regulations Part 645, and the NDDOT “A Policy for the Accommodation of Utilities on State Highway Right of Way”. Subpart A of 23 CFR Part 645 relates to Utility Relocation, Adjustment and Reimbursement. The Accommodation of Utilities is in Subpart B.

### **III-08.02 Preliminary Survey**

Seventy two (72) hours prior to starting the topography survey, the North Dakota One Call System (1-800-795-0555) should be contacted to have the underground utilities marked. Each caller will receive an ID number, and this number should be used for all future locate requests. Each utility is required to start marking the underground facilities within 72 hours. Should they be unable to be on the project within this time period, they must contact you to make other arrangements.

Be prepared to give the attendant each and every 1/4-1/4 section of land within which the survey will be conducted, along with the section, township, and range. Make sure that the attendant is given your name, title, and telephone number. The attendant will give you a request or confirmation number. Record this in the survey book.

You have the option of requesting an onsite meeting with the utilities prior to the marking of their underground facilities. This could result in reducing the time it takes to locate, mark, and survey unaffected utilities.

Be sure to record in the survey books each company, the locator’s name and telephone number, along with the dates of the locating and marking. Attempt to identify the utility name, size of facility, type of pipeline, and the type of transmittant in the pipeline.

### **III-08.03 Preliminary Utility Coordination**

The Designer or Consultant Project Manager shall meet with the NDDOT Utilities Engineer to discuss the Preliminary Utility Coordination milestone after the Environmental Document CATEX has been approved by FHWA. The Designer or Consultant Project Manager will meet with the NDDOT Utilities Engineer to discuss the alternate selected for the project, any preliminary potential utility impacts, review any available preliminary survey, information, or comments from the SOV letters, and discuss future utility coordination. After this meeting, a Preliminary Utility Coordination Letter shall be sent to all potential impacted Utility Co. requesting comments, share preliminary information, or further correspondence with Utility Co. as follows:

- **Design Division, Bridge Division, and District Projects**

The NDDOT Utilities Engineer will generate the Preliminary Utility Coordination Letter and available associated documents and distribute to the Utility Co.

- **Consultant Projects**

The Consultant Project Manager will generate the Preliminary Utility Coordination Letter and available associated documents and distribute to the Utility Co. The Consultant Project Manager shall send a copy to the Technical Support Person, and the Technical Support Person will forward to the NDDOT Utilities Engineer.

- **Local Government Projects (ND and US Highways)**

The Consultant Project Manager will generate the Preliminary Utility Coordination Letter and available associated documents and distribute to the Utility Co. The Consultant Project Manager shall send a copy to the Local Government Technical Support Person, and the Local Government Technical Support Person will forward to the NDDOT Utilities Engineer.

- **Local Government Projects (Urban & County Federal Aid Routes, TE, and SRTS)**

The local public agency will complete any necessary Preliminary Utility Coordination.

#### **III-08.04 Preliminary Utility Engineering**

During the design of the project, the Designer or Consultant Project Manager shall meet with the NDDOT Utilities Engineer to discuss the Preliminary Utility Engineering milestone. This meeting is to ascertain the location and extent of any utility relocations necessary to accommodate the planned project including any state optioned borrow sites, and where feasible and within acceptable design standards, to avoid relocation or adjustment or major or costly utilities without changing the scope of the project. The Utilities Engineer or Consultant Project Manager may at this time request comments, share preliminary information, or further correspondence with Utility Co.

Each above-ground utility that is to be relocated or lowered will be shown on the plan & profile sheets with the appropriate symbols.

On grading projects or projects with complex utility impacts, the NDDOT Utilities Engineer may request a plan note to be put in the plans requiring the contractor to hold a post bid utility coordination meeting. The contractor shall provide an agenda, tentative construction schedule for coordinating utility relocations, publish minutes from the meeting, and distribute to attendees. This plan note can be found on the Plan Preparation Guide (PPG) website.

### III-08.05 Notification to Utility Companies

After determination of the location and extent of utility relocations necessary to accommodate highway construction including any state optioned borrow sites, each Utility Co. affected is notified which of its facilities must be relocated or adjusted and which portions, if any, will be eligible for reimbursement.

The notification to the Utility Co. will include a Notification Letter, a Conflict Summary Sheet, highway plan sheets, including title sheet, scope of work sheet, plan and profile sheets, and when necessary, cross section sheets showing the approximate location of its facilities, which must be relocated or adjusted to accommodate highway construction. These plan sheets will also indicate which facilities will be reimbursed for relocation expenses, and which portions will not be reimbursable. Whenever possible, these utility coordination plan sheets will be made available to the potential bidders prior to the bid letting date via the NDDOT ePlans website. Depending on the complexity of the utility relocations or adjustments, a meeting may also be held between NDDOT Utilities Engineer or Consultant Project Manager with the affected Utility Co. and further correspondence. The Utility Co. is requested to proceed with the necessary field inspection, preparation of plans, and a cost estimate for the relocation work.

- **Design Division, Bridge Division, and District Projects**

The NDDOT Utilities Engineer will generate the Notification Letter, Conflict Summary Sheet, and associated documents/plan sheets and distribute to the Utility Co. and send a copy to the respective District.

- **Consultant Projects**

The Consultant Project Manager will generate the Notification Letter, Conflict Summary Sheet, and associated documents/plan sheets and distribute to the Utility Co. The Consultant Project Manager shall send a copy to the Technical Support Person and the respective District. The Technical Support Person will forward to the NDDOT Utilities Engineer.

- **Local Government Projects (US and ND Highways)**

The Consultant Project Manager will generate the Notification Letter, Conflict Summary Sheet, and associated documents/plan sheets and distribute to the Utility Co. The Consultant Project Manager shall send a copy to the Local Government Technical Support Person and the respective District. The Local Government Technical Support Person will forward to the NDDOT Utilities Engineer.

- **Local Government Projects (Urban & County Federal Aid Routes, TE, and SRTS)**

The local public agency will complete any necessary Notification to Utility Co.

The availability of substantially completed highway plans in advance of contract letting dates varies considerably. However, in general, it is NDDOT policy to provide the Utility Co. adequate lead time to make the necessary field investigation, to prepare a detailed cost estimate, and to complete the actual relocation work prior to the start of highway construction if possible. The required lead time will depend upon the extent and complexity of the relocation work and upon the capability of the particular Utility Co. However, it is the State's policy to notify the Utility Co. a minimum of three (3) months before the bid opening date, six (6) months is desirable, and sooner in some cases involving major facilities and projects. If final highway plans are available, notice may be sent to the Utility Co. a year or more prior to the contract letting date if circumstances so warrant. For utility permit information, see NDDOT policy "A Policy for Accommodation of Utilities on State Highway Right-of-Way."

### **III-08.06 Utility Agreements**

A determination must be made as to who is responsible for the costs of the relocation and adjustment work. The general rule is those who have prior rights will be reimbursed for the work. An exception to this rule is contained in Sections 24-01-42 and 43 of the North Dakota Century Code, which states that any utility that is placed within one-hundred feet of the centerline of any state highway right of way or within seventy-five feet of the centerline of any county highway right of way after 1959 must relocate, adjust, or remove the facilities at the Utility Co. expense.

Reimbursable utility work must be covered with a signed agreement between the NDDOT and the Utility Co. as follows:

- **Design Division, Bridge Division, and District Projects**

The NDDOT Utilities Engineer will send the required Agreement, and attach the Notification Letter, Cost Estimate for Relocation of Utility Facilities (SFN 5700), associated documents and plans to all Utility Co. that will be reimbursed for their relocations.

- **Consultant Projects**

The NDDOT Utilities Engineer will send the required Agreement, and attach the Notification Letter, Cost Estimate for Relocation of Utility Facilities (SFN 5700), associated documents and plans to all Utility Co. that will be reimbursed for their relocations. The Consultant Project Manager must send the Notification Letter and associated documents and plans to the Technical Support Person to forward to the NDDOT Utilities Engineer to be attached with the Agreement.

- **Local Government Projects (US and ND Highways)**

The NDDOT Utilities Engineer will send the required Agreement, and attach the Notification Letter, Cost Estimate for Relocation of Utility Facilities (SFN 5700), associated documents and plans to all Utility Co. that will be reimbursed for their relocations. The Consultant Project Manager must send the Notification Letter and associated documents and plans to the Local Government Technical Support Person to forward to the NDDOT Utilities Engineer to be attached with the Agreement.

- **Local Government Projects (Urban & County Federal Aid Routes, TE, and SRTS)**

The local public agency will complete any necessary agreements where local funds are used to move utilities. If federal aid is used to move utilities, then the Local Government Division will complete the necessary agreements.

Occasionally, a utility company may not return the Agreement documents on a timely basis, then a follow-up letter must be sent as a reminder to return the documents.

NOTE: The Utility Relocation Agreement must have the appropriate North Dakota Risk Management Appendix and Certificate of Insurance from the Utility Co. attached, along with the other required forms.

Any proposed betterments that the utility company proposes to make, and any cost sharing, shall be shown on the Cost Estimate form. Betterments are improvements to the company system that are not eligible for reimbursement. Examples of this would be heavier conductor on an overhead power line to increase capacity, larger size telephone or television cable, larger pipe size, etc.

Cost sharing is when the Department is only partially responsible for the costs of relocation, as shown in the plans. An example of this would be when there are four (4) miles of buried cable to be relocated and one (1) mile is located on highway right of way. If the total cable is of the same size, the state would be responsible for three-fourths of the cost (3 mile divided by 4 miles), and the utility would be responsible for one-fourth of the cost (1 mile divided by 4 miles). If the cable varies in sizes, then a formula based on foot/pairs must be used.

When the signed Agreement is returned to the NDDOT Utilities Engineer from the Utility Co., the documents will be submitted to the Legal Division and NDDOT Director for final approval.

### **III-08.07 Authorization**

The NDDOT Utilities Engineer will forward a request for federal aid to the Programming Division when it has been determined that a utility is eligible for reimbursement as noted above.

When notification from FHWA is received that the utility work is approved, the NDDOT Utilities Engineer will make the necessary copies of the Agreement and make distribution, and the utility will be authorized to start relocation. Any relocation work done by the utility prior to FHWA or NDDOT authorization date will not be eligible for reimbursement from the NDDOT.



### III-08.08 Certification

A utility certification letter must be sent to Programming for all projects. This utility certification letter certifies that the plans have been reviewed for utility impacts and notifications to Utility Co. have been made for all utility impacts for the project.

- **Design Division, Bridge Division, and District Projects**

The NDDOT Utilities Engineer shall send the certification letter to Programming.

- **Consultant Projects**

The Consultant Project Manager shall send the certification letter to the Technical Support Contact Person. The Technical Support Contact Person will forward the certification letter to the NDDOT Utilities Engineer. The NDDOT Utilities Engineer shall send a certification letter to Programming.

- **Local Government Projects (US and ND Highways)**

The Consultant Project Manager shall send the certification letter to the Local Government Technical Support Contact Person. The Local Government Technical Support Contact Person will forward the certification letter to the NDDOT Utilities Engineer. The NDDOT Utilities Engineer shall send a certification letter to Programming.

- **Local Government Projects (Urban & County Federal Aid Routes, TE, and SRTS)**

The local public agency will complete any necessary certification and submit this certification to the Local Government Technical Support Contact Person. The Local Government Technical Contact Person will forward a certification letter to Programming.

### III-08.09 Bid Letting Coordination

**Design Division, Bridge Division, District, Consultant Projects, and Local Government Projects (US and ND Highways)**

The NDDOT Utilities Engineer shall correspond with the Utility Co. and District following the bid opening. The NDDOT Utilities Engineer shall send a letter to the Utility Co. and District stating that the project has been let and identify the contact information for the Utility Co., Field Engineer, and Contractor.

**Local Government Projects (Urban & County Federal Aid Routes, TE, and SRTS)**

The local public agency or its' representative shall correspond with the Utility Co. and District following the bid opening. The local public agency or its' representative shall send a letter to the Utility Co. and District stating that the project has been let and identify the contact persons for the Utility Co., Field Engineer, and Contractor.

**III-08.10 Example Forms and Letters**

Sample forms and letters are available on the “Reference and Forms” page of the Design Manual website at: <http://www.dot.nd.gov/manuals/design/designmanual/reference-forms.htm>

### III-09.01 Introduction

The preparation of plans for streets and highways depends upon the type of roadway. Sign sizes depend on the roadway classification. There are many variables that should be considered when preparing the plans. The roadway type will determine the legend size, which will then determine the sign sizes. The various conditions will determine what signs are to be used. The MUTCD will provide the guidance necessary to determine what signs are needed for the site conditions. The Standard Highway Signs Booklet and the North Dakota Department of Transportation Standard Signs Supplement will provide the required sign sizes of the signs for the various classified roadways. Vertical and horizontal clearances will vary depending on the type of signs and the roadway classification.

#### III-09.01.01 Different Types of Construction

The type of construction determines how signing plans are prepared. The types are Preventive Maintenance, Minor Rehabilitation, Structural Improvement, Major Rehabilitation, and New or Reconstruction.

**Preventive Maintenance (PM):** Signs will not be required to be upgraded as part of these projects unless identified by the Statewide Safety Program. Signage not in compliance with the MUTCD will be updated if engineering judgment indicates that:

- One compliant device in the midst of a series of adjacent non-compliant devices could potentially be confusing to the road user.
- The anticipated schedule for replacement of the whole series of non-compliant devices will result in achieving timely compliance with the MUTCD.

All railroad crossings will have adequate warning/protective devices in place or be otherwise addressed in the State Railroad Crossing Improvement Program.

**Minor Rehabilitation (MiR):** Signs will not be required to be upgraded as part of these projects unless identified by the Statewide Safety Program. Signage not in compliance with the MUTCD will be updated if engineering judgment indicates that:

- One compliant device in the midst of a series of adjacent non-compliant devices could potentially be confusing to the road user.
- The anticipated schedule for replacement of the whole series of non-compliant devices will result in achieving timely compliance with the MUTCD.

All railroad crossings will have adequate warning/protective devices in place or be otherwise addressed in the State Railroad Crossing Improvement Program.

**Structural Improvement (SI):** All regulatory and warning signs and pavement markings will be verified to comply with current MUTCD standards or brought up to MUTCD standards if necessary, and all railroad crossings will have adequate warning/protective devices in place or be otherwise addressed in the State Railroad Crossing Improvement Program.

**Major Rehabilitation (MaR):** All regulatory and warning signs and pavement markings will be verified to comply with current MUTCD standards or brought up to MUTCD standards if necessary, and all railroad crossings will have adequate warning/protective devices in place or be otherwise addressed in the State Railroad Crossing Improvement Program.

**New or Reconstruction:** All regulatory and warning signs and pavement markings will be verified to comply with current MUTCD standards or brought up to MUTCD standards if necessary, and all railroad crossings will have adequate warning/protective devices in place or be otherwise addressed in the State Railroad Crossing Improvement Program.

### III-09.02 Different Types of Roadways

Tables III-09.01 – III-09.07 show standards for signing for different types of roadways.

#### III-09.02.01 Undivided Roadways

There are several types of roadways that determine the letter sizes, sign sizes, and vertical clearances. An undivided roadway can have various numbers of lanes: two-lane, three-lane, four-lane, and five-lane.

For a two-lane roadway that has one lane in each direction, the legend size will be used as shown in the Standard Highway Signs Booklet and the Supplement.

For a three-lane roadway that has one lane in each direction and a two-way left turn lane in the middle, the legend size will be used as shown in the Standard Highway Signs Booklet and the Supplement.

For a four-lane roadway that has two lanes in each direction, the legend size will be used as shown in the Standard Highway Signs Booklet and the Supplement.

For a five-lane roadway that has two lanes in each direction and a two-way left turn lane in the middle, the legend size will be used as shown in the Standard Highway Signs Booklet and the Supplement.

The sizes can be increased if an engineering study has determined that a larger size is needed.

The vertical clearances are as shown on Standard Drawings D-754-1 and D-754-23. These standard drawings can be found on the web at:

<http://www.dot.nd.gov/manuals/design/designmanual/designmanual.htm> under Standard Drawings.

### **III-09.02.02 Divided Highways**

#### **III-09.02.02.01 Expressways with Partial Control of Access**

Expressways have two types of access in North Dakota. Access is obtained using either interchanges or at-grade intersections.

Interchanges should be signed as shown in the MUTCD, Chapter 2F. The letter size for guide sign requirements are shown in Section III-09.08.01 and should be used for the signs stated. The regulator and warning sign legend size should be as shown in the Standard Highway Signs Booklet for Expressways.

At-grade intersections should have Stop control, One Way signs, and Divided Highway signs installed at the intersection. Routes should be signed as shown for Conventional Roads, Chapter 2D in the MUTCD. Where stop or signal controls are used, the route turn assembly should be placed across the roadway.

The median width will govern whether yield and one-way signs are to be placed. See Figures 1 thru 4A in Appendix III-09 A.

#### **III-09.02.02.02 Freeways**

Freeways are to be signed as shown in the MUTCD, Chapter 2F. Letter size for guide sign requirements are shown in Section III-09.08.02 and should be used for the signs stated. The regulator and warning sign legend size should be as shown in the Standard Highway Signs Booklet for Freeways.

See Appendix III-09 B and Appendix III-09 C for Interchange Numbering, Names and Classification for I-94 & I-29 respectively.

The overall dimensions of the regulatory and warning signs shall be as shown in Table III-09.01, III-09.02, and III-09.03 or as shown in the MUTCD in Table 2B-1: Regulatory Sign Sizes, 2C-2: Warning Sign Sizes, and 2C-3: Minimum Size of Supplemental Warning Plaques.

Table III-09.01: Regulatory Sign Sizes (Table 2B-1 in the MUTCD)

Sign	MUTCD Code	Section	Conventional Road (in)	Expressway (in)	Freeway (in)	Minimum (in)	Oversized (in)
Stop	R1-1	SB.04	30 x 30	36 x 36	-	24 x 24	48 x 48
Yield	R1-2	2B.08	36 x 36 x 36	48 x 48 x 48	60 x 60 x 60	30 x 30 x 30	-
To Oncoming Traffic	R1-2a	-	24 x 12	-	-	-	-
4-Way	R1-3	2B.04	12 x 6	-	-	-	-
All Way	R1-4	2B.04	18 x 6	-	-	-	-
Yield Here to Peds	R1-5	2B11	18 x 18	-	-	-	-
Yield Here to Pedestrians	R1-5a	2B.11	18 x 24	-	-	-	-
In-Street Ped Crossing	R1-6,6a	2B1.12	12 x 36	-	-	-	-
Speed Limit	R2-1	2B.13	24 x 30	36 x 48	48 x 60	-	-
Truck Speed Limit	R-2-2	2B.14	24 x 24	36 x 36	48 x 48	-	-
Night Speed Limit	R2-3	2B.15	24 x 24	36 x 36	48 x 48	-	-
Minimum Speed Limit	R2-4	2B.16	24 x 30	36 x 48	48 x 60	-	-
Combined Speed Limit	R2-4a	2B.16	24 x 48	36 x 72	48 x 96	-	-
Fines Higher	R2-6	2B.17	24 x 24	36 x 36	48 x 48	-	-
Turn Prohibition	R3-1,2,3,4,18	2B.19	24 x 24	36 x 36	-	-	48 x 48
Mandatory Movement Lane Control	R3-5 Series	2B.21	30 x 36	-	-	-	-
Optional Movement Lane Control	R3-6	2B.22	30 x 36	-	-	-	-
Mandatory Movement Lane Control	R3-7	2B.21	30 x 30	-	-	-	-
Advance Intersection Lane Control	R3-8,8a,8b	2B.23	(variable x 30)	-	-	-	-
Two-Way Left Turn Only (overhead mounted)	R3-9a	2B.24	30 x 36	-	-	-	-
Two-Way Left Turn Only (ground mounted)	R3-9b	2B.24	24 x 36	-	-	-	36 x 48
Reversible Lane Control (symbol)	R3-9d	2B.25	108 x 48	-	-	-	-
Reversible Lane Control (ground mounted)	R3-9f	2B.25	30 x 42	-	-	-	-
Advance Reversible Lane Control Transition Signing	R3-9g,9h	2B.25	108 x 36	-	-	-	-
End Reverse Lane	R3-9i	2B.25	108 x 48	-	-	-	-
Preferential Only Lane Ahead (ground mounted)	R3-10 series	2B.26	30 x 42	36 x 60	78 x 96	-	-
Preferential Only Lane Operation (ground mounted)	R3-11 series	2B.26	30 x 42	-	78 x 96	-	-
Preferential Only Lane Ends (ground mounted)	R3-12 series	2B.26	36 x 42	36 x 60	48 x 84 48 x 96	-	-
Preferential Only Lane Ahead (overhead mounted)	R-13 series	2B.26	66 x 36	84 x 48	144 x 78 144 x96	-	-
Preferential Only Lane Operation (Overhead mounted)	R-14 series	2B.26	72 x 60	96 x 72	144 x106 144 x 124 144 x 90	-	-
HOV 2+ Lane Ends (Overhead Mounted)	R3-15 series	2B.26	66 x 36	84 x 48	102 x 60	-	-
Do Not Pass	R4-1	2B.29	24 x 30	36 x 48	48 x 60	18 x 24	-
Pass With Care	R4-2	2B.30	24 x 30	36 x 48	48 x 60	18 x 24	-

Sign	MUTCD Code	Section	Conventional Road (in)	Expressway (in)	Freeway (in)	Minimum (in)	Oversized (in)
Slower Traffic Keep Right	R4-3	2B.31	24 x 30	36 x 48	48 x 60	-	-
Trucks Use Right Lane	R4-5	2B.32	24 x 30	36 x 48	48 x 60	-	-
Trucks Lane XX Feet	R4-6	2B.32	24 x 30	36 x 48	48 x 60	-	-
Keep Right	R4-7,7a,7b	2B.33	24 x 30	36 x 48	48 x 60	18 x 24	-
Keep Left	R4-8	2B.33	24 x 30	36 x 48	48 x 60	18 x 24	-
Do Not Enter	R5-1	2B.34	30 x 30	36 x 36	48 x 48	-	-
Wrong Way	R5-1a	2B.35	36x 24	36 x 24	42 x 30	-	-
No Trucks	R5-2,2a	2B.36	24 x 24	30 x 30	36 x 36	-	48 x 48
No Motor Vehicles	R5-3	2B.36	24 x 24	-	-	-	-
Commercial Vehicles Excluded	R5-4	2B.36	24 x 30	36 x 48	48 x 60	-	-
Vehicles with Lugs Prohibited	R5-5	2B.36	24 x 30	36 x 48	48 x 60	-	-
No Bicycles	R5-6	2B.36	24 x 24	30 x 30	36 x 36	-	48 x 48
Non-Motorized Traffic Prohibited	R5-7	2B.36	30 x 24	42 x 24	48 x 30	-	-
Motor-Driven Cycles Prohibited	R5-8	2B.36	30 x 24	42 x 24	48 x 30	-	-
Pedestrians, Bicycles Motor-Driven Cycles Prohibited	R5-10a	2B.36	30 x 36	-	-	-	-
Pedestrians and Bicycles Prohibited	R5-10b	2B.36	30 x 18	-	-	-	-
Pedestrians prohibited	R5-10c	2B.36	24 x 12	-	-	-	-
One Way	R6-1	2B.37	36 x 12	54 x 18	54 x 18	-	-
One Way	R6-2	2B.37	24 x 30	36 x 48	36 x 48	18 x 24	-
Divided Highway Crossing	R6-3, 3a	2B.38	30 x 24	36 x 30	-	24 x 18	-
No Parking	R7- 1,2,2a,3,4,5,6, 7,8, 107,108	2B.39	12 x 18	-	-	-	-
Van Accessible	R7-8a,8b	2B.40	18 x 9	-	-	12 x 6	-
No Parking, Bike Lane	R7-9,9a	9B.09	12 x 18	-	-	-	-
No Parking (with transit logo)	R7-107a	2B.39	12 x 30	-	-	-	-
No Parking/ Restricted Parking (combined sign)	R7-200	2B.40	24 x 18 12 x 30	-	-	-	-
Tow Away Zone	R7-201,201a	2B.40	12 x 6	-	-	-	-
This Side of Sign	R7-202	2B.39	12 x 6	-	-	-	-
No Parking on Pavement	R8-1	2B.39	24 x 30	36 x 48	48 x 60	-	-
No Parking Except on Shoulder	R8-2	2B.39	24 x 30	36 x 48	48 x 60	-	-
No Parking	R8-3	2B.39	24 x 30	36 x 36	48 x 48	18 x 24	-
No Parking (symbol)	R8-3a	2B.39	24 x 24	36 x 36	48 x 48	12 x 12	-
Emergency Parking Only	R8-4	2B.42	30 x24	30 x 24	48 x 36	-	-
No Stopping on Pavement	R8-5	2B.39	24 x 30	36 x 48	48 x 60	-	-
No Stopping Except on Shoulder	R8-6	2B.39	24 x 30	36 x 48	48 x 60	-	-
Emergency Stopping Only	R8-7	2B.42	30 x 24	48 x 36	-	-	-
Do Not Stop on Tracks	R8-8	2B.42	24 x 30	36 x 48	-	-	-
Tracks Out of Service	R8-9	8B.09	24 x 24	36 x 36	-	18 x 18	-
Stop Here When Flashing	R8-10	8B.10	24 x 36	-	-	24 x 30	-
Walk on Left Facing Traffic	R9-1	2B.43	18 x 24	-	-	-	-
Cross Only at Crosswalks	R9-2	2B.44	12 x 18	-	-	-	-
No Pedestrian Crossing	R9-3	2B.44	12 x 18	-	-	-	-
No Pedestrian Crossing (symbol)	R9-3a	2B.44	18 x 18	24 x 24	30 x 30	-	-
Use Crosswalk	R9-3b	2B.44	18 x 12	-	-	-	-
No Hitch Hiking	R9-4	2B.43	18 x 24	-	-	18 x 18	-

Sign	MUTCD Code	Section	Conventional Road (in)	Expressway (in)	Freeway (in)	Minimum (in)	Oversized (in)
Hitch Hiking Prohibition (symbol)	R9-4a	2B.43	18 x 18	-	-	-	-
Bicyclists (symbol) Use Ped Signal	R9-5	9B.10	12 x 18	-	-	-	-
Bicyclists (symbol) Yield to Peds	R9-6	9B.10	12 x 18	-	-	-	-
Keep Left/Right to Pedestrians & Bicyclists (symbols) - Travel-path Restriction	R9-7	9B.11	12 x 18	-	-	-	-
Pedestrian Crosswalk	R9-8	6F.12	36 x 18	-	-	-	-
Sidewalk Closed	R9-9	6F.13	30 x 18	-	-	-	-
Sidewalk Closed, Use Other Side	R9-10	6F.13	48 x 24	-	-	-	-
Sidewalk Closed Ahead, Cross Here	R9-11	6F.13	48 x 36	-	-	-	-
Sidewalk Closed, Cross Here	R9-11a	6F.13	48 x 24	-	-	-	-
Cross On Green Light Only	R10-1	2B.45	12 x 18	-	-	-	-
Pedestrian Traffic Signal Signs	R10-2, 2a,3,3a,3b, 3c,3d,4,4a,4b	2B.45	9 x 12	-	-	-	-
Countdown Pedestrian Sign	R10-3e	2B.45	9 x 15	-	-	-	-
Left on Green Arrow Only	R10-5	2B.45	24 x 30	-	-	-	48 x 60
Stop Here on Red	R10-6	2B.45	24 x 36	-	-	-	-
Stop Here on Red	R10-6a	2B.45	24 x 30	-	-	-	-
Do Not Block Intersection	R10-7	2B.45	24 x 30	-	-	-	-
Use Lane with Green Arrow	R10-8	2B.45	24 x 30	36 x 42	-	-	60 x 72
Left (Right) Turn Signal	R10-10	2B.45	24 x 30	-	-	-	-
No Turn on Red	R10-11,11a	2B.45	24 x 30	-	-	-	48 x 48
No Turn on Red	R10- 11b	2B.45	24 x 24	-	-	-	30x30
Left Turn Yield on Green	R10-12	2B.45	24 x 30	-	-	-	-
Emergency Signal	R10-13	2B.45	36 x 24	-	-	-	-
Turning Traffic Must Yield To Pedestrians	R10-15	2B.45	30 x 36	-	-	-	-
U-Turn Yield to Right Turn	R10-16	2B.45	30x 36	-	-	-	-
Right on Red Arrow After Stop	R10-17a	2B.45	30 x 36	-	-	-	-
Traffic Laws Photo Enforced	R10-18	2B.46	36 x 18	48 x 30	72 x 36	-	-
Photo Enforced	R10-19	2B.46	24 x 18	36 x 30	48 x 36	-	-
MON-FRi (any times) (3 lines)	R10-20a	2B.45	24 x 24	-	-	-	-
SUNDAY (any times) (2 lines)	R10-20a	2B.45	24 x 18	-	-	-	-
Left Turn Signal - Yield on Green	R10-21	2B.45	30 x 36	-	-	-	-
Bike Actuation	R10-22	9B.12	12 x 18	-	-	-	-
Keep Off Median	R11-1	2B.47	24 X 30	-	-	-	-
Road Closed	R11-2	2B.48	48 X 30	-	-	-	-
Road Closed – Local Traffic Only	R11-3,3a, 3b,4	2B.48	60 X 30	-	-	-	-
Weight Limit	R12-1,2	2B.49	24 X 30	36 X 48	-	-	36 X 48
Weight Limit	R12-3	2B.49	24 X 36	-	-	-	-
Weight Limit	R12-4	2B.49	36 X 24	-	-	-	-
Weight Limit	R12-5	2B.49	24 X 36	36 X 48	48 X 60	-	-
Metric Plaque	R12-6	2B.49	24 X 9	-	-	-	-
Weigh Station	R13-1	2B.50	72 X 48	96 X 66	120 X 84	-	-
Truck Route	R14-1	2B.51	24 X 18	-	-	-	-



Sign	MUTCD Code	Section	Conventional Road (in)	Expressway (in)	Freeway (in)	Minimum (in)	Oversized (in)
Hazardous Materials	R14-2,3	2B.52	24 X 24	30 X 30	36 X 36	-	42 x 42
National Network	R14-4,5	2B.53	24 X 24	30 X 30	36 X 36	-	42 x 42
Railroad Crossing	R15-1	8B.03	48 X 9	-	-	-	-
Look	R15-8	8B.16	36 X 18	-	-	-	-

## Notes:

1. Larger signs may be used when appropriate.
2. Dimensions are shown in inches and shown as width x height.

Table III-09.02: Warning Sign Sizes (Table 2C-2 in the MUTCD)

Description		Conventional Road (in)	Expressway (in)	Freeway (in)	Minimum (in)	Oversized (in)
Shape	Sign Series					
Diamond	W1,W2,W7, W8,W9,W11, W14,W15-1, W17-1	30 x 30	36 x 36	48 x 48	24 x 24	-
	W1 Combination, W3,W4,W5,W6, W8-3,W10,W12	36 x 36	48 x 48	48 x 48	30 x 30	-
Rectangular	W1 - Arrows	48 x 24	-	-	36 x 18	60 x 30
	W1 - Chevron	18 x 24	30 x 36	36 x 48	12 x 18	-
	W7-4	78 x 48	78 x 48	78 x 48	-	-
	W7-4,4c	78 x 60	78 x 60	78 x 60	-	-
	W10-9,10	24 x 18	-	-	-	-
	W12-2p	84 x 24	84 x 24	84 x 24	-	-
	W13-2, 3, 5, W25	24 x 30	36 x 48	48 x 60	24 x 30	48 x 60
Pennant	W14-3	36 x 48 x 48	-	-	30 x 40 x 40	48 x 64 x 64
Circular	W10-1	36 Dia.	48 Dia.	-	30 Dia.	48 Dia.

## Notes:

1. Larger signs may be used when appropriate.
2. Dimensions are shown in inches and shown as width x height.

Table III-09.03: Minimum Size of Supplemental Warning Plaques (Table 2C-3 in the MUTCD)

Size of Warning Sign	Size of Supplemental Plaque (in)			
	Rectangular			Square
	1 Line	2 Line	Arrow	
24 x 24 30 x 30	24 x 12	24 x 18	24 x 12	18 x 18
36 x 36 48 x 48	30 x 18	30 x 24	30 x 18	24 x 24

## Notes:

1. Larger supplemental plaques may be used when appropriate.
2. Dimensions are shown in inches and shown as width x height.

Table III-09.04: Minimum Sign Sizes on Low-Volume Roads (Table 5A-1 in the MUTCD)

Sign	MUTCD Code	Section	Sign Sizes (in)		
			Typical	Minimum	Oversized
Stop	R1-1	5B.02	30 x 30	-	36 x 36
Yield	R1-2	5B.02	30 x 30 x 30		36 x 36 x 36
Speed Limit	R2-1	5B.03	24 x 30	18 x 24	36 x 48
Do Not Pass	R4-1	5B.04	24 x 30	18 x 24	36 x 48
Pass With Care	R4-2	5B.04	24 x 30	18 x 24	36 x 48
Keep Right	R4-7	5B.04	24 x 30	18 x 24	36 x 48
Do Not Enter	R5-1	5B.04	30 x 30	-	36 x 36
No Trucks	R5.2	5B.04	24 x 24	-	30 x 30
One Way	R6-2	5B.04	18 x 24	-	24 x 30
No Parking	R8-3	5B.05	18 x 24	-	24 x 30
No Parking (symbol)	R8-3a	5B.05	24 x 24	18 x 18	30 x 30
No Parking (plaque)	R8-3c,3d	5B.05	24 x 18	18 x 12	30 x 24
Road Closed	R11-2	5B.04	48 x 30	-	-
Road Closed, Local Traffic Only	R11-3a	5B.04	60 x 30	-	-
Bridge out, Local Traffic Only	R11-3b	5B.04	60 x 30	-	-
Weight Limit	R12-1	5B.04	24 x 30	-	36 x 48
Railroad Crossbuck	R15-1	5F.02	48 x 9	-	-
Number of Tracks	R15-2	5F.02	27 x 18	-	-
Horizontal Alignment	W-1,2,3,4,5	5C.02	24 x 24	-	30 x 30
One-Direction Large Arrow	W1-6	5C.02	36 x 18	-	48 x 24
Two-Direction Large Arrow	W1-7	5C.02	36 x 18	-	48 x 24
Chevron Alignment	W1-8	5C.02	12 x 18	-	18 x 24
Intersection Warning	W2-1,4,5	5C.03	24 x 24	-	30 x 30
Stop Ahead	W3-1	5C.04	30 x 30	24 x 24	36 x 36
Yield Ahead	W3-2	5C.04	30 x 30	24 x 24	36 x 36
Be Prepared to Stop	W3-4	5G.05	36 x 36	30 x 30	48 x 48
Narrow Bridge	W5-2	5C.05	30 x 30	24 x 24	36 x 36
One Lane Bridge	W5-3	5C.06	30 x 30	24 x 24	36 x 36
Hill	W7-1,1a	5C.07	24 x 24	-	30 x 30
XX % Grade	W7-3	5C.07	24 x 18	-	30 x 24
Next XX miles	W7-3a	5C.09	24 x 18	-	30 x 24
Pavement Ends	W8-3	5C.08	30 x 30	24 x 24	36 x 36
Loose Gravel	W8-7	5G.05	30 x 30	24 x 24	36 x 36
Railroad Advance Warning	W10-1	5F.03	24 Dia.	18 Dia.	30 Dia.
Crossing Warning	W10-2,3,4	5F.03	30 x 30	24 x 24	36 x 36
Entering/Crossing	W11 Series	5C.09	24 x 24	-	30 x 30
Advisory Speed (plaque)	W13-1	5C.10	18 x 18	-	24 x 24
Dead End/No Outlet	W14-1,2	5C.11	30 x 30	24 x 24	36 x 36
Dead End/No Outlet	W14-1a,2a	5C.11	36 x 9	24 x 6	-
No Passing Zone (pennant)	W14 -3	5G.05	30 x 40 x 40	24 x 36 x 36	36 x 48 x 48
Supplemental Distance (plaque)	W16-2	5C.09	24 x 18	18 x 12	30 x 24
Ahead (plaque)	W16-9p	5C.09	24 x 12	-	30 x 18
No Traffic Signs	W18-1	5C.12	30 x 30	24 x 24	36 x 36
Road Work XX Ft	W20-1	5G.05	36 x 36	30 x 30	48 x 48
Flagger	W20-7a	5G.05	36 x 36	30 x 30	48 x 48
Workers	W21-1a	5G.05	36 x 36	30 x 30	48 x 48
Fresh Oil	W21-2	5G.05	24 x 24	-	30 x 30
Road Machinery Ahead	W21-3	5G.05	24 x 24	-	30 x 30
Shoulder Work	W21-5	5G.05	24 x 24	-	30 x 30
Survey Crew	W21-6	5G.05	30 x 30	24 x 24	36 x 36

## Notes:

1. Larger signs may be used when appropriate.
2. Dimensions are shown in inches and shown as width x height.

**Table III-09.05: Size of School Area Signs and Plaques (Table 7B-1 in the MUTCD)**

Sign	MUTCD Code	Section	Conventional Road (in)	Minimum (in)	Oversized (in)
School Advance Warning	S1-1	7B.08	36 x 36	30 x 30	48 x 48
School Bus Stop Ahead	S3-1	7B.10	30 x 30	-	36 x 36
Reduced Speed School Zone Ahead	S4-5,S4-5a	7B.12	36 x 36	30 x 30	48 x 48
School Speed Limit XX When Flashing	S5-1	7B.11	24 x 48	-	36 x 72
End School Zone	S5-2	7B.13	24 x 30	-	36 x 48
Speed Limit (School Use)	R2-1	7B.11	24 x 30	-	36 x 48
X:XX to X:XX AM X:XX to X:XX PM	S4-1	7B.11	24 x 10	-	36 x 18
When Children Are Present	S4-2	7B.11	24 x 10	-	36 x 18
School	S4-3	7B.11	24 x 8	-	36 x 12
When Flashing	S4-4	7B.11	24 x 10	-	36 x 18
Mon-Fri	S4-6	7B.11	24 x 10	-	36 x 18
XXX Feet	W16-2	7B.08	24 x 18	-	30 x 24
XXX Ft	W16-2a	7B.08	24 x 12	-	30 x 18
Diagonal Arrow	W16-7p	7B.09	24 x 12	-	30 x 18
Diagonal Arrow (Optional Size)	W16-7p	7B.09	21 x 15	-	-
Ahead	W16-9p	7B.08	24 x 12	-	30 x 18

**Table III-09.06: Sign Sizes for Grade Crossing Signs (Table 8B-1 in the MUTCD)**

Sign	MUTCD Code	Section	Conventional Road (in)	Expressway	Freeway	Minimum	Oversized
No Right Turn Across Tracks	R3-1a	8.B.06, 10c.09	24 x 30	-	-	-	-
No Left Turn Across tracks	R3-2a	8B.06, 10C.09	24 x 30	-	-	-	-
Do Not Stop on Tracks	R8-8	8B.07, 10C.05	24 x 30	-	-	-	-
Tracks Out of Service	R8-9	8B.09, 10C.06	24 x 24	-	-	-	-
Stop Here When Flashing	R8-10	8B.10, 10C.08	24 x 36	-	-	-	-
Stop Here on Red	R10-6	8B.11, 10C.07	24 x 36	-	-	-	-
No Turn on Red	R10-11a	8D.07 10C.09	24 x 30	-	-	-	-
Highway-Rail Grade Crossing (Crossbuck)	R15-1	8B.03, 10C.02	48 x 9	-	-	-	-
Number of Tracks	R15-2	8B.03, 10C.02	27 x 18	-	-	-	-
Exempt	R15-3	8B.05, 10C.10	24 x 12	-	-	-	-
Light Rail Only Right Lane	R15-4a	10C.13	23 x 30	-	-	-	-
Light Rail Only Left Lane	R15-4b	10C.13	24 x 30	-	-	-	-
Light Rail Only Center Lane	R15-4c	10C.13	24 x 30	-	-	-	-
Light Rail Do Not Pass	R15-5	10C.14	24 x 30	-	-	-	-
Do Not Pass Stopped Train	R15-5a	10C.14	24 x 30	-	-	-	-
Do Not Drive On Tracks Light Rail Symbol	R15-6	10C.12	24 x 24	-	-	-	-
Do Not Drive On Tracks	R15-6a	10C.12	24 x 30	-	-	-	-
Light Rail Divided Highway Symbol	R15-7	10C.11	24 x 24	-	-	-	-
Light Rail Divided Highway Symbol (T-Intersection)	R15-7a	10C.11	24 x 24	-	-	-	-
Look	R15-8	8B.16, 10C.03	36 x 18	-	-	-	-
Highway-Rail Grade Crossing Advance Warning	W10-1	8B.04, 10C.15	36 Dia.	-	-	-	-
Exempt	W10-1a	8B.05, 10C.10	24 x 12	-	-	-	-
Highway-Rail Grade Crossing Advance Warning	W10-2,3,4	8B.04, 10C.15	36 x 36	-	-	-	-
Low Ground Clearance Highway-Rail Grade Crossing	W10-5	8B.17, 10C.16	36 x 36	-	-	-	-
Light Rail Activated Blank-out Symbol	W10-7	10C.17	24 x 24	-	-	-	-
Trains May Exceed (80MPH)	W10-8	8B.13	36 x 36	-	-	-	-
No Train Horn	W10-9	8B.14	24 x 18	-	-	-	-
No Signal	W10-10	8B.15	24 x 18	-	-	-	-
Storage Space Symbol	W10-11	8B.18, 10C.18	36 x 36	-	-	-	-

Sign	MUTCD Code	Section	Conventional Road (in)	Expressway	Freeway	Minimum	Oversized
Storage Space XX Feet Between Tracks & Highway	W10-11a	8B.18, 10C.18	30 x 36	-	-	-	-
Storage Space XX Feet Between Highway & Tracks Behind You	W10-11b	8B.18, 10C.18	30 x 36	-	-	-	-
Skewed Crossing	W10-12	8B.19, 10C.19	36 x 36	-	-	-	-
No Gates or Lights	W10-13	8B.15	24 x 18	-	-	-	-
Next Crossing	W10-14	8B.17	24 x 18	-	-	-	-
Use Next Crossing	W10-14a	8B.17	24 x 18	-	-	-	-
Rough Crossing	W10-15	8B.17	24 x 18	-	-	-	-
Light Rail Station Symbol	I-12	10C.20	24 x 24	-	-	-	-
Emergency Notification	I-13	8B.12, 10C.21	30 x 30	-	-	-	-
Emergency Notification	I-13a	8B.12, 10C.21	30 x 18	-	-	-	-

## Notes:

1. Larger signs may be used when appropriate.
2. Dimensions are shown in inches and shown as width x height.

**Table III-09.07: Minimum Sign Sizes for Bicycle Facilities (Table 9B-1 in the MUTCD)**

Sign	MUTCD Code	Minimum Sign Size – (in)	
		Shared-Use Path	Roadway
Stop	R1-1	18 x 18	30 x 30
Yield	R1-2	18 x 18 x 18	30 x 30 x 30
Bike Lane	R3-17	-	30 x 24
Bicycle Lane Supplemental Plaques	R3-17a,b	-	30 x 12
Movement Restriction	R4-1,2,3,7	12 x 18	18 x 24
Begin Right Turn Lane Yield to Bikes	R4-4	-	36 x 30
Bicycle Wrong Way	R5-1b	12 x 18	12 x 18
No Motor Vehicles	R5-3	24 x 24	24 x 24
No Bicycles	R5-6	24 x 24	24 x 24
No Parking Bike Lane	R7-9,9a	-	12 x 18
Pedestrians Prohibited	R9-3a	18 x 18	18 x 18
Ride With Traffic Plaque	R9-3c	12 x 12	12 x 12
Bicycle Regulatory	R9-5,6	12 x 18	12 x 18
Shared-Use Path Restriction	R9-7	12 x 18	-
Push Button for Green Light	R10-3	9 x 12	9 x 12
To Request Green Wait on Symbol	R10-22	12 x 18	12 x 18
Railroad Crossbuck	R15-1	24 x 4.5	48 x 9
Turn and Curve Warning	W1-1,2,3,4,5	18 x 18	24 x 24
Arrow Warning	W1-6,7	24 x 12	36 x 18
Intersection Warning	W2-1,2,3,4,5	18 x 18	24 x 24
Stop, Yield, Signal Ahead	W3-1,2,3	18 x 18	30 x 30
Narrow Bridge	W5-2	18 x 18	30 x 30
Bikeway Narrows	W5-4a	18 x 18	30 x 30
Hill	W7-5	18 x 18	24 x 24
Bump or Dip	W8-1,2	18 x 18	24 x 24
Bicycle Surface Condition	W8-10	18 x 18	24 x 24

Sign	MUTCD Code	Minimum Sign Size – (in)	
		Shared-Use Path	Roadway
Bicycle Surface Condition Plaque	W8-10p	12 x 9	12 x 9
Advance Grade Crossing	W10-1	15 Dia.	15 Dia.
Bicycle Warning	W11-1	18 x 18	24 x 24
Pedestrian Crossing	W11-2	18 x 18	24 x 24
Low Clearance	W12-2	18 x 18	30 x 30
Playground	W15-1	18 x 18	24 x 24
Share the Road Plaque	W16-1	-	18 x 24
Diagonal Arrow Plaque	W16-7p	-	24 x 12
Bicycle Guide	D1-1b	24 x 6	24 x 6
Street Name	D1-1c	18 x 6	18 x 6
Bicycle Parking	D4-3	12 x 18	12 x 18
Bike Route	D11-1	24 x 18	24 x 18
Bicycle Route Sign	M1-8	12 x 18	12 x 18
Interstate Bicycle Route Sign	M1-9	18 x 24	18 x 24
Bicycle Route Supplemental Plaques	M4-11,12,13	12 x 4	12 x 4
Route Sign Supplemental Plaques	M7-1,2,3,4,5,6,7	12 x 9	12 x 9

### II-09.02.03 Location

There are two types of locations that will vary the positions of signs.

#### III-09.02.03.01 Urban

In urban areas, signs are usually positioned nearer the roadway and higher above the roadway, and at closer spacing.

There may be parked vehicles or pedestrians present in urban areas, therefore the vertical clearance should be higher.

#### III-09.02.03.02 Rural

In rural areas, signs are usually positioned further from the roadway and at greater spacing. The horizontal and vertical placements for both urban and rural highways are shown on the sign location drawings.

### III-09.03 Signing for Rural State Highway Projects (Non-Interstate)

The existing sign locations should be plotted from the sign inventory and PaveTech videos. The PaveTech videos will give the messages of the various signs. If there is a conflict between the signs shown on the sign inventory, versus those shown on the PaveTech videos, the videos should be considered correct.

A check of Stop Control or Yield Control should be made and a determination made if they are required. The existing signs should also be checked to determine if any are non-standard. See figures labeled Sign Locations and Stop Sign Location, Wide Throat Intersection in Appendix III-09 A.

Curve Signing: The warning signs such as turn sign, curve sign, reverse curve sign, etc., are part of what is known as the alignment series. See Warning Signs in Section III-09.04.

Junction Signing should be checked to determine if signs are correctly placed.

1. If Stop Ahead signs are in place and new grading will change the view of the intersection, these signs could possibly be removed. The removal of the Stop Ahead sign should be discussed with the designer and Traffic Operations in Planning.
2. If a crossroad is a state-numbered route and is not a county route, junction signing should be installed.
3. Distance and Destination (D&D) signs should be as shown on Traffic Operation Maps.
4. Route-Turn Route-Marker Assemblies should be placed across the intersecting roadway where stop or signal conditions exist.
5. Advance-Turn Route-Marker Assemblies should be placed only at intersections where the route you are on turns right or left.

The following figures, giving details on junction signing requirements, are located in Appendix III-09 A.

1. **Figures A through N** show junction signing requirements.
2. **Figure A** shows the junction signing required at a T-type intersection where the junctioning roadway terminates with a through Expressway roadway. A recovery approach should be installed at the location shown. If the recovery approach cannot be placed, the Double Arrow sign and the T symbol sign should be installed.
3. **Figure B** shows the junction signing required at a two lane highway that begins, a second highway that turns, and a third highway that continues through the intersection. This layout requires a junction sign and an advance turn arrow.
4. **Figure C** shows junction signing required where two state highways intersect with a third through state highway, forming a T-intersection. All are two lane two-way roadways. A recovery approach should be installed at the location shown. If the recovery approach cannot be placed, the Double Arrow sign and the T symbol sign should be installed.
5. **Figure D** shows typical intersection signing where two state highways intersect and the intersection is signalized. Both are two lane two-way roadways.
6. **Figure E** shows typical signing at a T-type intersection formed by two state highways where the junctioning roadway is the through roadway and the other turns. Both are two lane two-way roadways. This layout requires a junction sign and an advance turn arrow. A recovery approach should be installed at the location shown. If the recovery approach cannot be placed, the Double Arrow sign and the T symbol sign should be installed.
7. **Figure F** shows the intersection of a state highway and an important local road. Both are two lane two-way roadways. An advance warning sign is placed to warn of the intersection.
8. **Figure G** shows the signing requirements for an interchange ramp and a two lane, two-way county routes.
9. **Figure H** shows the signing requirements for an interchange ramp and a two lane, two-way state highways.
10. **Figure I** shows the junction signing required at T-type intersections where a county road junctions, follows the state route for a distance, then turns. This layout requires junction signs and advance turn arrows. A recovery approach should be installed at the location shown. If the recovery approach cannot be placed, the Double Arrow sign and the T symbol sign should be installed.
11. **Figure K** shows the signing for a complex intersection of county highways and a state highway. Junction signs, turn signs, and advance turn signs may be required.



12. **Figure L** shows the junction signing requirements at the intersection of a county route and a state route, with a two-way stop on the county route.
13. **Figure M** shows the junction signing requirements at a T-intersection of a county route and a through state route and with a stop on the county road. A recovery approach should be installed at the location shown. If the recovery approach cannot be placed, the Double Arrow sign and the T symbol sign should be installed.
14. **Figure N** is a Radial T-intersection showing the junction of a state route and a county or township roadway. When the route connecting with the state route is a county road, the junction sign should be installed. Where the curvature in the county route or township route is designed for a speed that is less than the posted speed, an Advisory Speed Plate should be placed below the curve sign. The Stop Ahead symbol sign should be installed when Stop signs are placed. A recovery approach should be installed at the location shown. If the recovery approach cannot be placed, the Double Arrow sign should be installed.

Transition Signing: From a divided roadway to a two lane roadway. This is shown in Figure O in Appendix III-08 A.

15. **Figure O** is the transition of a divided roadway to a two lane two-way roadway. The layout shows the required signs and their locations. The pavement marking and the delineators should also be placed as shown. Where distances between divided roadway sections is 50 miles or less, two-way signs should be installed at approximately every 7 miles along the two-way two lane roadway. The two-way signs should be placed on both sides of the roadway. Where distances between divided roadway sections is over 50 miles, two-way signs should only be placed for the traffic leaving the divided highway.

Climbing Lane Signing: Climbing lane and pavement marking for slow moving traffic. This is shown in Figure P in Appendix III-08 A.

### III-09.04 Warning Signs

Warning signs should only be placed where an existing or potential hazardous condition exists.

Changes in horizontal alignment may have curve warning signs, and where the curve is hidden by vertical curvature or other conditions, the following should be followed.

Whether or not a particular curve needs to be signed is based on recommended speed at which the curve may be traversed. This speed may be determined by the use of the curves in Figure III-08.04 by the use of the ball bank indicator, or by mathematical computation.

The curves given in Figure III-08.04 are used when the radius (R) and super-elevation (e) of the curve are known. The radius and superelevation of the curve may be obtained from actual measurements or from construction plans for the roadway. The combination of radius and superelevation giving the lowest speed for the curve should be used.

The ball bank indicator is a curved level which is used to determine the safe speed around a curve as indicated by trial speed runs.

A curve with radius of more than 11,450 feet does not need a curve sign.

Where curves have radii of between 3,820 and 11,450 feet, and the sight distance is good, no curve signs may be needed. Where a curve is hidden by vertical curvature, a curve sign is needed.

Where a curve has a radius less than 3,820 feet, it should be reviewed to determine if curve signs are required by one of the methods stated above.

Intersections may be marked when the crossroad has a high volume of traffic and is hidden from the approaching traffic. An engineering study should be made to determine the need for such signing.

Reverse turn sign, Reverse curve sign, and winding road sign are intended for use where there are curves or turns separated by tangent distance of less than 600 ft.

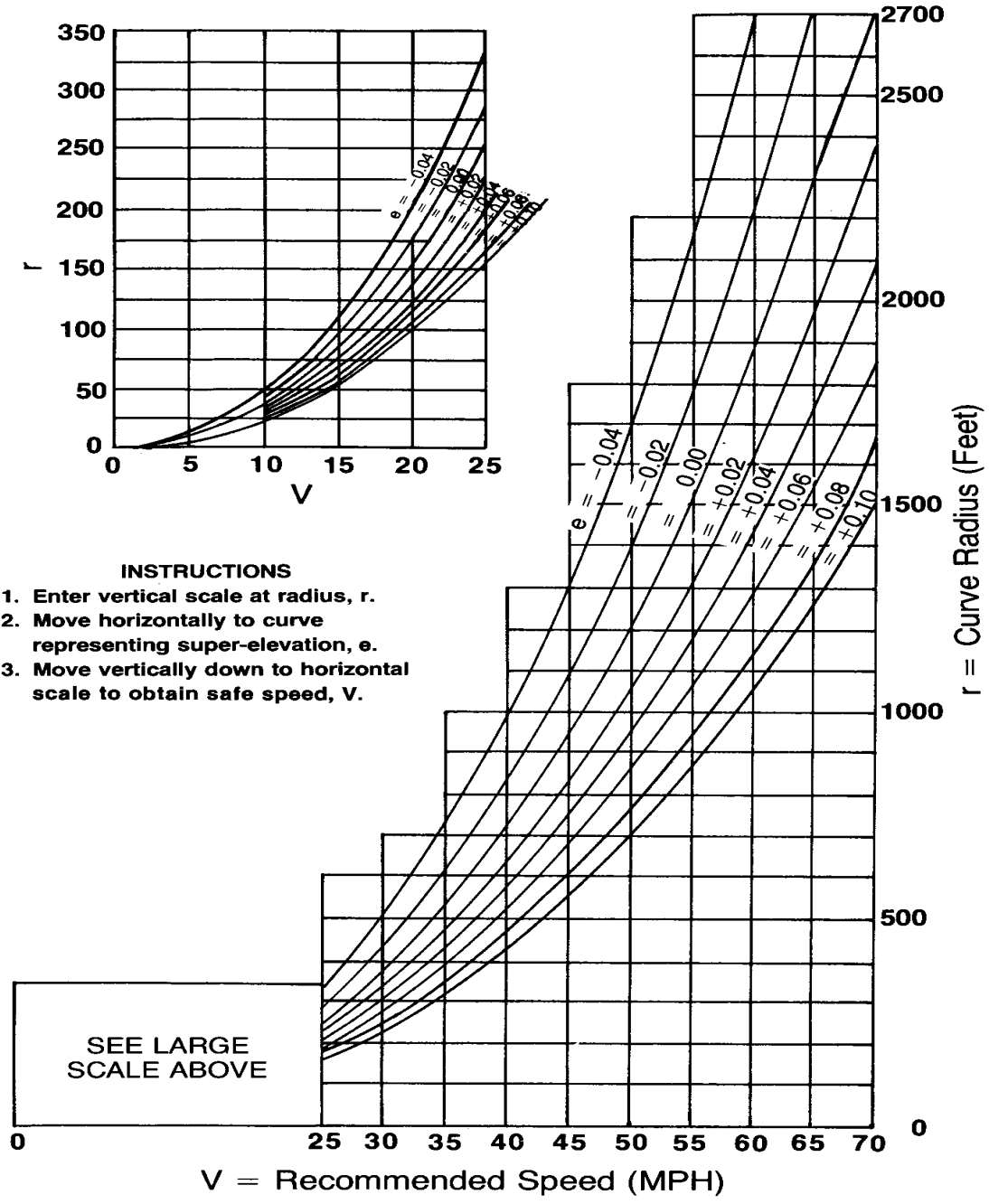


Figure III-08.04

**III-09.04.01 Advance Warning of Control Devices**

- Converging traffic lanes should be signed using the merge symbol when it has been determined that merging traffic is unexpected. An engineering study should be made to warrant this sign, unless it is already in place.
- Where the roadway narrows abruptly to a width that two vehicles cannot pass safely without reducing speed, a Road Narrows sign should be installed.
- Where there are changes in the highway design, such as a one lane bridge, beginning or ending of a divided highway, etc., there should be signs installed warning of such conditions.
- Where down grades have conditions such as length, percent of grade, horizontal curvature, or other physical features, the Hill sign should be installed.
- Where roadway surface conditions change, a Pavement Ends symbol and Slippery When Wet sign should be installed.
- Railroad crossings should have the advance crossing sign installed.
- Various other crossing conditions, such as bicycle, pedestrian, deer, cattle, and farm machinery, may warrant installation of warning signs.
- There are miscellaneous types of signs that may be placed to warn motorists of pending conditions. See the MUTCD for these signs.
- When lowering the speed limit for a speed zone, Reduced Speed Ahead signs should be installed prior to the change in speed limit. Guidelines for advance distance placement should be determined from Table III-08.08 (Table 2C-4 in the MUTCD).

The MUTCD provides guidance on the placement of warning signs. Chapter 2C contains Table 2C-4, Guidelines for Advance Placement of Warning Signs.

**Table III-09.08 Guidelines for Advance Placement of Warning Signs (Table 2C-4 in the MUTCD)**

Posted or 85th-Percentile Speed	Advance Placement Distance <sup>1</sup>								
	Condition A: Speed reduction and lane changing in heavy traffic <sup>2</sup>	Condition B: Deceleration to the listed advisory speed (mph) for condition <sup>4</sup>							
		0 <sup>3</sup>	10	20	30	40	50	60	70
20 mph	225 ft	N/A <sup>5</sup>	N/A <sup>5</sup>	-	-	-	-	-	-
25 mph	325 ft	N/A <sup>5</sup>	N/A <sup>5</sup>	N/A <sup>5</sup>	-	-	-	-	-
30 mph	450 ft	N/A <sup>5</sup>	N/A <sup>5</sup>	N/A <sup>5</sup>	-	-	-	-	-
35 mph	550 ft	N/A <sup>5</sup>	N/A <sup>5</sup>	N/A <sup>5</sup>	N/A <sup>5</sup>	-	-	-	-
40 mph	650 ft	125 ft	N/A <sup>5</sup>	N/A <sup>5</sup>	N/A <sup>5</sup>	-	-	-	-
45 mph	750 ft	175 ft	125 ft	N/A <sup>5</sup>	N/A <sup>5</sup>	N/A <sup>5</sup>	-	-	-
50 mph	850 ft	250 ft	200 ft	150 ft	100 ft	N/A <sup>5</sup>	-	-	-
55 mph	950 ft	325 ft	275 ft	225 ft	175 ft	100 ft	N/A <sup>5</sup>	-	-
60 mph	1100 ft	400 ft	350 ft	300 ft	250 ft	175 ft	N/A <sup>5</sup>	-	-
65 mph	1200 ft	475 ft	425 ft	400 ft	350 ft	275 ft	175 ft	N/A <sup>5</sup>	-
70 mph	1250 ft	550 ft	525 ft	500 ft	425 ft	350 ft	250 ft	150 ft	-
75 mph	1350 ft	650 ft	625 ft	600 ft	525 ft	450 ft	350 ft	250 ft	100 ft

1. The distances adjusted for a sign legibility distance of 175 ft for Condition A. The distance for Condition B has been adjusted for a sign legibility distance of 250 ft, which is appropriate for an alignment warning symbol sign.
2. Typical conditions are locations where the road user must use extra time to adjust speed and change lanes in heavy traffic because of a complex driving situation. Typical signs are Merge and Right Lane Ends. The distances are determined by providing the driver a PIEV time of 14.0 to 14.5 seconds for vehicle maneuvers (2001 AASHTO Policy, Exhibit 3-3, Decision Sight Distance, Avoidance Maneuver E) minus the legibility distance of 175 ft for the appropriate sign.
3. Typical condition is the warning of a potential stop situation. Typical signs are Stop Ahead, Yield Ahead, Signal Ahead, and Intersection Warning signs. The distances are based on the 2001 AASHTO Policy, Stopping Sight Distance, Exhibit 3-1, providing a PIEV time of 2.5 seconds, a deceleration rate of 11.2 ft/sec<sup>2</sup>, minus the sign legibility distance of 175 ft.
4. Typical conditions are locations where the road user must decrease speed to maneuver through the warning condition. Typical signs are Turn, Curve, Reverse Turn, or Reverse Curve. The distance is determined by providing a 2.5 seconds PIEV time, a vehicle deceleration rate of 10 ft/sec<sup>2</sup>, minus the sign legibility distance of 250 ft.
5. No suggested distances are provided for these speeds, as the placement location is dependent on site conditions and other signing to provide an adequate advance warning to the driver.

### III-09.05 Guide Signs

Guide signs are essential to guide vehicle operators along streets and highways, to inform them of interesting routes, to direct them to cities, towns, villages, or other important destinations, to identify nearby rivers and streams, parks, forests, and historic sites, and generally give such information as will help them along their way in the most simple, direct manner possible.

Guide signs on conventional roads are covered in the MUTCD, Parts 2D.

Cities may be signed by placing city signs on either end of a community.

Historical areas may be signed if an engineering study warrants the installation of such signing. Service signing may be signed if an engineering study warrants its installation.

The airport Symbol signs shall point in the direction of the airport.

### III-09.06 Regulatory Signs

Regulatory signs inform highway users of traffic laws or regulations and indicate the applicability of legal requirements that would not otherwise be apparent. These signs should be erected wherever needed to fulfill this purpose, but unnecessary mandates should be avoided. Some North Dakota laws specify that certain regulations are enforceable only when made known by official signs, such as special speed limit zones, handicap parking areas, etc.

The MUTCD covers regulatory signing in Chapter 2B.

North Dakota state laws prescribe the following speed limits:

- Speed limit on Interstate routes is 75 mph, unless otherwise posted.
- Speed limit on Expressway routes is 70 mph, unless otherwise posted.
- Speed limit on US and state routes is 65 mph day, unless otherwise posted.
- Speed limit on all highways and streets in business or residential districts is 25 mph, unless posted otherwise.

These regulations generally result in the need for speed limit signing only at major intersections or entrances to highways, and at locations where speed limits change or are different than that specified by law. State law also limits speed limit change increments to a maximum of 20 mph. Locations where the speed limit changes more than 20 mph, therefore, require intermediate speed signs.

Speed Limits signs should be located at the point where the limit changes. Speed Limits signs should also be located at entrances and or boundaries to metropolitan areas.

#### **III-09.06.1 Typical Speed Zone Signing**

**Rural.** When multiple Speed Limits are used to decrease speeds, the signs should be placed at distances corresponding to the amount of speed change and the initial speed. Table III-09.09 indicates spacing between successive Speed Limit signs when the speeds are being reduced based on comfortable deceleration. See **Figure R** for placement of signs. If the reduction of speed limits must have more signs than are shown because of State Law, additional signs on both sides of the roadway will be required accordingly.

The speed limit on projects should be reviewed by opening the RIMS#HP program and the speed limit signs should be placed at the location shown. If project require the repositioning the speed limit signs, the new position shall be provided to the Traffic Operations Section, Planning Division.

**Urban.** The speed limit on urban projects should be reviewed with the city personnel.

**Table III-09.09 Minimum Speed Signing Placement**

		Approach Speed (mph)								
		70	65	60	55	50	45	40	35	30
Reduced Speed (mph)	65	430								
	60	720	390							
	55	1000	660	350						
	50	1250	910	600	310					
	45	1470	1140	820	540	270				
	40	1670	1340	1030	740	470	230			
	35	1850	1520	1200	920	650	410	200		
	30	2000	1670	1360	1070	810	570	350	160	
	25	2140	1800	1490	1200	940	700	480	290	120
	20	2240	1910	1600	1310	1040	800	590	390	230
15	2340	1990	1680	1390	1130	890	670	480	310	

- Distances are rounded to the nearest interval of 10 ft.
- Based on 2 sec of PIEV time, vehicle deceleration/acceleration rate of 2.3 ft/sec<sup>2</sup> (typical deceleration in gear braking), and legibility distance of 100 ft.
- Good engineering practice indicates that speed reduction through a speed zone should be signed at intervals no greater than 15 mph. The gray shaded numbers are speed reductions greater than 15 mph.

State law specifies standard signing and marking for handicap parking, including an advisement of the fine for the improper use of such parking areas. Also, state law specifies that vehicles may not be parked on the paved or main traveled portions of any rural highway, so it generally is not necessary to place parking restriction signs in rural areas unless a special problem exists.

Other mandatory signing are specified by Century Code.

Stop sign usage generally requires Stop signs on all side road approaches to state highways, such as graded section line roads, township and county routes, city streets, commercial drives, etc. Generally, field drives and single party private drives carry minimal traffic and do not require signing. Warrants for other types of regulatory signs are included in the MUTCD and should generally be followed when determining the need for this type of signing.

**III-09.07 Sign Placement**

The typical section should be used to determine the position of signs on the side of the roadway. Perforated tube supports are placed on the foreslope of the roadway. Standard pipe are placed on the foreslope, secondary slope, flat ditch bottom, backslope, or original ground. This information should be obtained for the design of the sign supports. This will be discussed further in subsequent paragraphs.

**III-09.07.01 Lateral Offset**

- **All Highways** – Signs should be 6 feet minimum from the edge of the finished shoulder and 60 feet maximum from the center of the sign to the edge of the driving lane.
- **Interstate** – Signs should be 6 feet from the finished shoulder for regulatory signs, warning signs, and route markers. Variable message guide signs are normally placed at 60 feet from the edge of the driving lane. If the roadside conditions will not allow this placement, place them on the foreslope 6 feet from the finished shoulder.
- **Expressways & Conventional Roadways** – Signs should be 16 feet from the edge of the driving lane.
- **Bikeways** – Signs should be 3 feet minimum and 6 feet maximum from edge of bikeway.

**III-09.07.02 Mounting Height****Standard:**

1. Signs installed at the side of the road in rural districts shall be at least 5 feet and a maximum of 6 feet, measured from the bottom of the sign to the near edge of the driving lane. Where parking or pedestrian movements occur, the clearance to the bottom of the sign shall be at least 7 feet and a maximum of 8 feet.
2. Directional signs on expressway and freeways shall be installed with a minimum height of 7 feet and a maximum of 8 feet. If a secondary sign is mounted below another sign, the major sign shall be installed at least 8 feet and a maximum of 9 feet and the secondary sign at least 5 feet and a maximum of 6 feet above the level of the edge of the driving lane. All route signs, warning signs, and regulatory signs on expressways and freeways shall be at least 7 feet and a maximum of 8 feet above the level of the edge of the driving lane. Overhead mounted signs shall provide a vertical clearance of not less than 19 feet to the sign, light fixture, walkway, or sign bridge, over the entire width of the pavement and shoulders except where a lesser vertical clearance is used for design of other structures.
3. Where signs are placed 30 feet or more from the edge of the travel way, the height to the bottom of such signs may be 5 feet and a maximum of 6 feet above the level of the edge of the driving lane.



4. Mounting height from the ground-mounted signs on shared-use paths shall be a minimum of 4 feet and a maximum of 5 feet, measured from bottom edge of the sign to the near edge of the paved surface.
5. When overhead signs are used on a shared-use path, the clearance from the bottom edge of the sign to the path surface directly under the sign shall be a minimum of 8 ft.

### III-09.08 Sign Face Design

The sign face layouts for standard signs, such as Regulatory, Warning, and Route Markers, are found in the Standard Highway Signs Booklet and the North Dakota Supplement.

The variable message signs, such as Distance & Destination signs, Services Signing, Weigh Station Signing, Historical Areas Signing, Recreational Areas Signing, Street Name Signing, etc., should be designed using the GuidSign Program with the following requirements:

<b>Sign Height:</b>	<b>Radius:</b>
0 to 24 inches (2 ft) -----	Use 3 inch radius
Over 24 (2 ft) to 48 inches (4 ft) -----	Use 6 inch radius
Over 48 (4 ft) to 72 inches (6 ft) -----	Use 9 inch radius
Over 72 inches (6 ft) and over -----	Use 12 inch radius
<b>Major Lettering Text Height:*</b>	<b>Border:</b>
0.0 to 9.9 inches-----	Use 1.25 inch border
10 to 14.9 inches -----	Use 2.0 inch border
15 inches and larger -----	Use 3.0 inch border

- \* **Exceptions:** Exit Panels - Use 1.25 inch Border  
Gore Signs - Use 2 Inch Border

All letters on Variable Message Signs should be Clearview Highway Font.

Distance and Destination signs on conventional roads should have 6" Upper Case and 4 1/2" Lower Case letters.

Variable Message Signs for Expressways and Freeways should be as follows: The in-place signs should be checked to determine if they comply with the legend requirements in Sections III-09.08.01 and III-09.08.02. If not, they should be replaced

#### III-09.08.01 Expressways

The word messages in the legends of expressway guide signs should be in letters at least 8 inches high. Larger lettering is necessary for major guide signs. The following table is Table 2E-1: Minimum Letter and Numeral Sizes for Expressway Guide Signs According to Interchange Classification, in the MUTCD.

Type of Sign	Type of Interchange (See Appendix III-09 B1 & B2)				Overhead
	Major		Intermediate	Minor	
	Category a	Category b			
<b>A. Advance Guide, Exit Direction, and Overhead Guide Signs</b>					
Exit Plaque					
Word	10	10	10	8	10
Numeral & Letter	15	15	15	12	15
Interstate Route Sign					
Numeral	18	-	-	-	18
1- or 2-Digit Shield	36 x 36	-	-	-	36 x 36
3-Digit Shield	45 x 36	-	-	-	45 x 36
US or State Route Shield					
Numeral	18	18	18	12	18
1- or 2-Digit Shield	36 x 36	36 x 36	36 x 36	24 x 24	36 x 36
3-Digit Shield	45 x 36	45 x 36	45 x 36	30 x 24	45 x 36
Cardinal Direction					
First Letter	18	15	12	10	15
Rest of Word	15	12	10	8	12
Name of Destination					
Upper-Case Letters	20	16	13.3	10.6	16
Lower-Case Letters	15	12	10	8	12
Distance Number	18	15	12	10	15
Distance Fraction	12	10	10	8	10
Distance Word	12	10	10	8	10
Action Message Word	10	10	10	8	10
<b>B. Gore Signs</b>					
Word	10	10	10	8	-
Numeral & Letter	12	12	12	10	-

See Section 2E.29, MUTCD, Interchange Classification. The following table is Table 2E-2: Minimum Letter and Numeral Sizes for Expressway Guide Signs According to Sign Type in the MUTCD.

Type of Sign	Minimum Size (inches)	Type of Sign	Minimum Size (inches)
<b>A. Pull Through Signs</b>		<b>F. Distance Signs</b>	
Destination – Upper-Case Letters	13.3	Word – Upper-Case Letters	8
Destination – Lower-Case Letters	10	Word – Lower-Case Letters	6
Route Sign as Message		Numeral	8
Cardinal Direction	10	<b>G. General Services Signs</b>	
1- or 2-Digit Shield	36 x 36	Exit Number Word	8
3-Digit Shield	45 x 36	Exit Number Numeral and Letter	12
<b>B. Supplemental Guide Signs</b>		Services	8
Exit Number Word	8	<b>H. Rest Area and Scenic Area Signs</b>	
Exit Number Numeral and Letter	12	Word	10
Place Name – Upper-Case Letters	10.6	Distance Numeral	12
Place Name – Lower-Case Letters	8	Distance Fraction	8
Action Message	8	Distance Word	10
<b>C. Changeable Message Signs</b>		Action Message Word	10
Characters	10.6*	<b>I. Reference Location Signs</b>	
<b>D. Interchange Sequence Signs</b>		Word	4
Word – Upper-Case Letters	10.6	Numeral	10
Word – Lower-Case Letters	8	<b>J. Boundary and Orientation Signs</b>	
Numeral	10	Word – Upper-Case Letters	8
Fraction	8	Word – Lower-Case Letters	6
<b>E. Next X Exits Sign</b>		<b>K. Next Exit and Next Services Signs</b>	
Place Name – Upper-Case Letters	10.6	Word and Numeral	8
Place Name – Lower-Case Letters	8	<b>L. Exit Only Signs</b>	
NEXT X EXITS	8	Word	12

\*Changeable Message Signs may often require larger sizes than the minimum. A size of 18 in should be used where traffic speeds are greater than 55 mph, in areas of persistent inclement weather, or where complex driving tasks are involved.

**III-09.08.02 Freeways**

The word messages in the legends of Freeway guide signs should be in letters at least 8 inches high. Larger lettering is necessary for major guide signs. The following table is Table 2E-3: Minimum Letter and Numeral Sizes for Freeway Guide Signs According to Interchange Classification in the MUTCD.

Type of Sign	Type of Interchange (See Appendix III-09 B1 & B2)				Overhead
	Major		Intermediate	Minor	
	Category a	Category b			
<b>A. Advance Guide, Exit Direction, and Overhead Guide Signs</b>					
Exit Plaque					
Word	10	10	10	10	10
Numeral & Letter	15	15	15	15	15
Interstate Route Sign					
Numeral	24/18	-	-	-	18
1- or 2-Digit Shield	48x48/36x36	-	-	-	36 x 36
3-Digit Shield	60x48/45x36	-	-	-	45 x 36
US or State Route Sign					
Numeral	24/18	18	18	12	18
1- or 2-Digit Shield	48x48/36x36	36 x 36	36 x 36	24 x 24	36 x 36
3-Digit Shield	60x48/45x36	45 x 36	45 x 36	30 x 24	45 x 36
Cardinal Direction					
First Letter	18	12	15	10	15
Rest of Word	15	12	12	8	12
Name of Destination					
Upper-Case Letters	20	20	16	13.3	16
Lower-Case Letters	15	15	12	10	12
Distance Number	18	18/15	15	12	15
Distance Fraction	12	12/10	10	8	10
Distance Word	12	12/10	10	8	10
Action Message Word	12	12/10	10	8	10
<b>B. Gore Signs</b>					
Word	12	12	12	8	-
Numeral & Letter	15	15	15	10	-

Note: (/) Slant bar signifies separation of desirable and minimum sizes.

See Section 2E.29, MUTCD, Interchange Classification. The following table is Table 2E-2: Minimum Letter and Numeral Sizes for Freeway Guide Signs According to Sign Type in the MUTCD.

Type of Sign	Minimum Size (inches)	Type of Sign	Minimum Size (inches)
<b>A. Pull Through Signs</b>		<b>G. General Services Signs</b>	
Destination – Upper-Case Letters	16	Exit Number Word	10
Destination – Lower-Case Letters	12	Exit Number Numeral and Letter	15
Route Sign as Message		Services	10
Cardinal Direction	12	<b>H. Rest Area and Scenic Area Signs</b>	
1- or 2-Digit Shield	36 x 36	Word	12
3-Digit Shield	45 x 36	Distance Numeral	15
<b>B. Supplemental Guide Signs</b>		Distance Fraction	10
Exit Number Word	10	Distance Word	12
Exit Number Numeral and Letter	15	Action Message Word	12
Place Name – Upper-Case Letters	13.3	<b>I. Reference Location Signs</b>	
Place Name – Lower-Case Letters	10	Word	4
Action Message	10	Numeral	10
<b>C. Changeable Message Signs</b>		<b>J. Boundary and Orientation Signs</b>	
Characters	10.6*	Word – Upper-Case Letters	8
<b>D. Interchange Sequence Signs</b>		Word – Lower-Case Letters	6
Word – Upper-Case Letters	13.3	<b>K. Next Exit and Next Services Signs</b>	
Word – Lower-Case Letters	10	Word and Numeral	8
Numeral	13.3	<b>L. Exit Only Signs</b>	
Fraction	10	Word	12
<b>E. Next X Exits Sign</b>		<b>M. Diagrammatic Signs</b>	
Place Name – Upper-Case Letters	13.3	Lane Widths	5
Place Name – Lower-Case Letters	10	Lane Line Segments	1 x 6
NEXT X EXITS	10	Gap Between Lane Lines	6
<b>F. Distance Signs</b>		Stem Height (up to upper point of departure)	30
Word – Upper-Case Letters	8	Arrowhead (standard “up” arrow)	8
Word – Lower-Case Letters	6	Space Between Arrowhead & Route Shield	12
Numeral	8		

\*Changeable Message Signs may often require larger sizes than the minimum. A size of 18 in should be used where traffic speeds are greater than 55 mph, in areas of persistent inclement weather, or where complex driving tasks are involved.

### **III-09.08.03 Interline and Edge Spacing**

Interline spacing of upper-case letters should be approximately 3/4 the average of the upper-case letter heights in the adjacent lines of letters.

The spacing to the top and bottom borders should be approximately equal to the average of the letter height of the adjacent line of letters. The lateral spacing to the vertical border should be essentially the same as the height of the largest letter.

### **III-09.08.04 Arrows**

On all exit direction signs, both overhead and ground-mounted, arrows should be upward slanting and located on side of the sign where the exit leaves the mainline.

Downward pointing arrows are lane assignment arrows and should only be used on overhead guide signs to prescribe the use for specific lanes for traffic bound for a destination or route that can be reached only by being in the lane(s) so designated.

Examples of arrows for use on guide signs are shown on Standard Drawing D-754-9.

### **III-09.08.05 Gore Sign Location**

The placement of gore signs should be as shown on Standard Drawing D-754-1.

### **III-09.09 Sign Support Design**

Sign supports are designed using the requirements of the Standard Specifications for Structural Supports for Highway Signs, Luminaires, and Traffic Signals.

The type of post used on conventional roads and expressways should be perforated tube, unless the sign configuration does not allow the use of this type. If the design requirements cannot be met using perforated tube posts, the sign supports should be standard pipe or W-shape posts. On Interstate highways, sign supports should be standard pipe or W-shape. Single post signs should use standard pipe with concrete foundations. Gore signs should use standard pipe with concrete foundations. All other signs should use two or more W-shape posts on piling.

Conventional highways should have sign supports designed using the sections shown on Standard Drawing D-754-23.

For information to calculate sign supports, see Appendix III-09 D or on the web at <http://www.dot.nd.gov/manuals/manuals-publications.htm> under Sign Calculator.

### **III-09.10 Sign Retroreflective Requirements**

The retroreflective material used in the fabrication of sign faces should be either Type IV or Type XI sheeting.

Type IV reflective sheeting should be used on all signs except the following:

- Type XI sheeting should be used on all regulatory and warning signs (including school signs).

Figure 1 - Divided Highway - Traffic Control without turn lane. Roadway Separation less than 30'.

Figure 1A - Divided Highway - Traffic Control without turn lane, Single Approach. Roadway Separation less than 30'.

Figure 2 - Divided Highway - Traffic Control with turn lanes. Roadway Separation less than 30'.

Figure 2A - Divided Highway - Traffic Control with turn lanes, Single Approach. Roadway Separation less than 30'.

Figure 3 - Divided Highway - Traffic Control without turn lane. Roadway Separation 30' or more.

Figure 3A - Divided Highway - Traffic Control without turn lane. Single Approach. Roadway Separation 30' or more.

Figure 4 - Divided Highway - Traffic Control with turn lanes. Roadway Separation 30' or more.

Figure 4A - Divided Highway - Traffic Control with turn lane. Single Approach. Roadway Separation 30' or more.

#### Sign Locations

Figures A and B - Typical Rural Intersection Signing

Figures C and D - Typical Rural Intersection Signing

Figures E and F - Typical Rural Intersection Signing

Figures G and H - Typical Ramp Terminal Signing

Figure I - State and County Route Intersection Signing

Figure K - State and County Route Signing At Complex Intersections

Figure L - State and County Route Signing At Two Way Stop Intersections

Figure M - State and County Route Signing at T-Type Intersections

Figure N - State and County Route or Twp Road Signing at Radial "T" Intersection

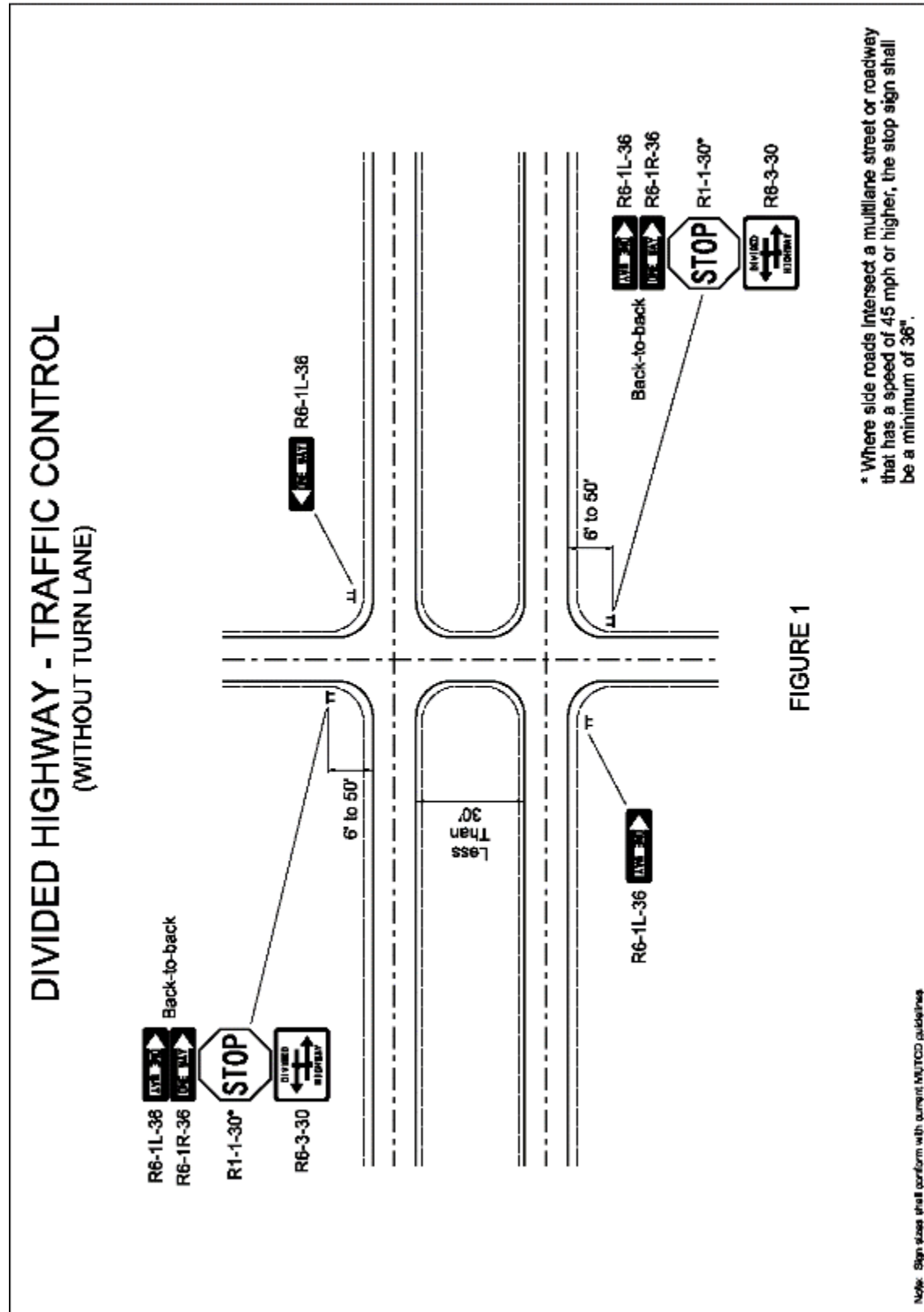
Figure O - Roadway Transitions - Divided Roadway to Two Way Two Lane

Figure P - Climbing Lane Signing and Marking

Figure R - Typical Speed Zone Signing

Figure S - Turning Route Marking

Figure T - Do Not Enter and Wrong Way Signs





**DIVIDED HIGHWAY - TRAFFIC CONTROL  
(SINGLE APPROACH)  
(WITHOUT TURN LANE)**

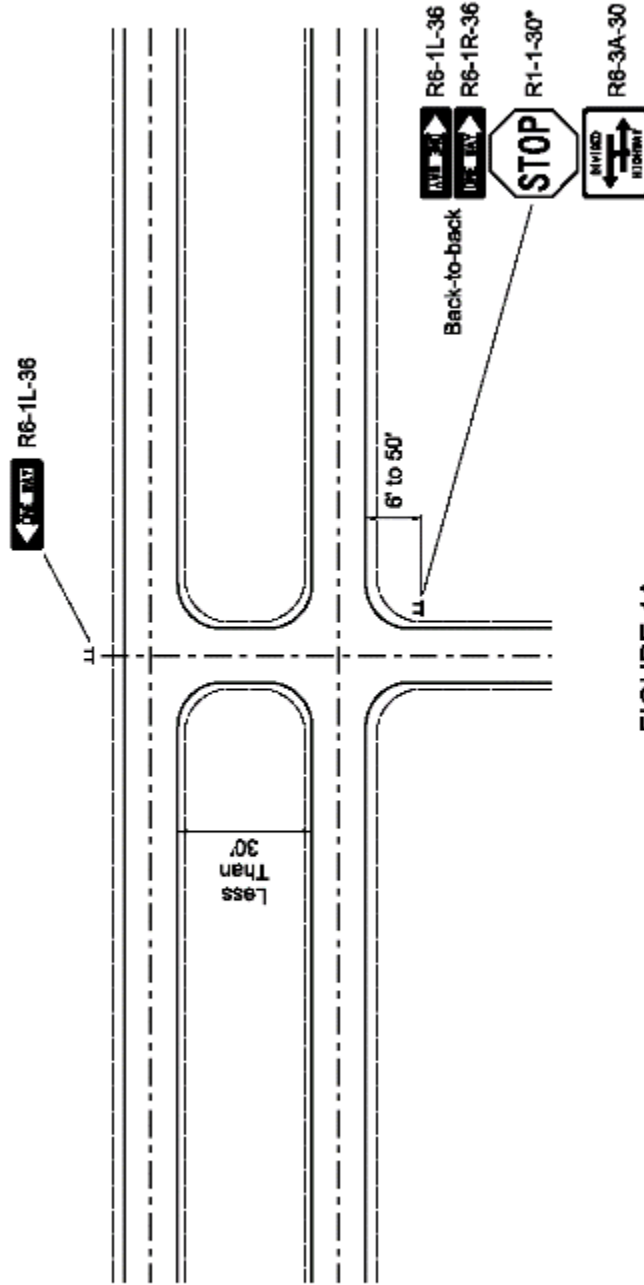


FIGURE 1A

\* Where side roads intersect a multilane street or roadway that has a speed of 45 mph or higher, the stop sign shall be a minimum of 36".

Note: Sign sizes shall conform with current MUTCD guidelines

# DIVIDED HIGHWAY - TRAFFIC CONTROL (WITH TURN LANE)

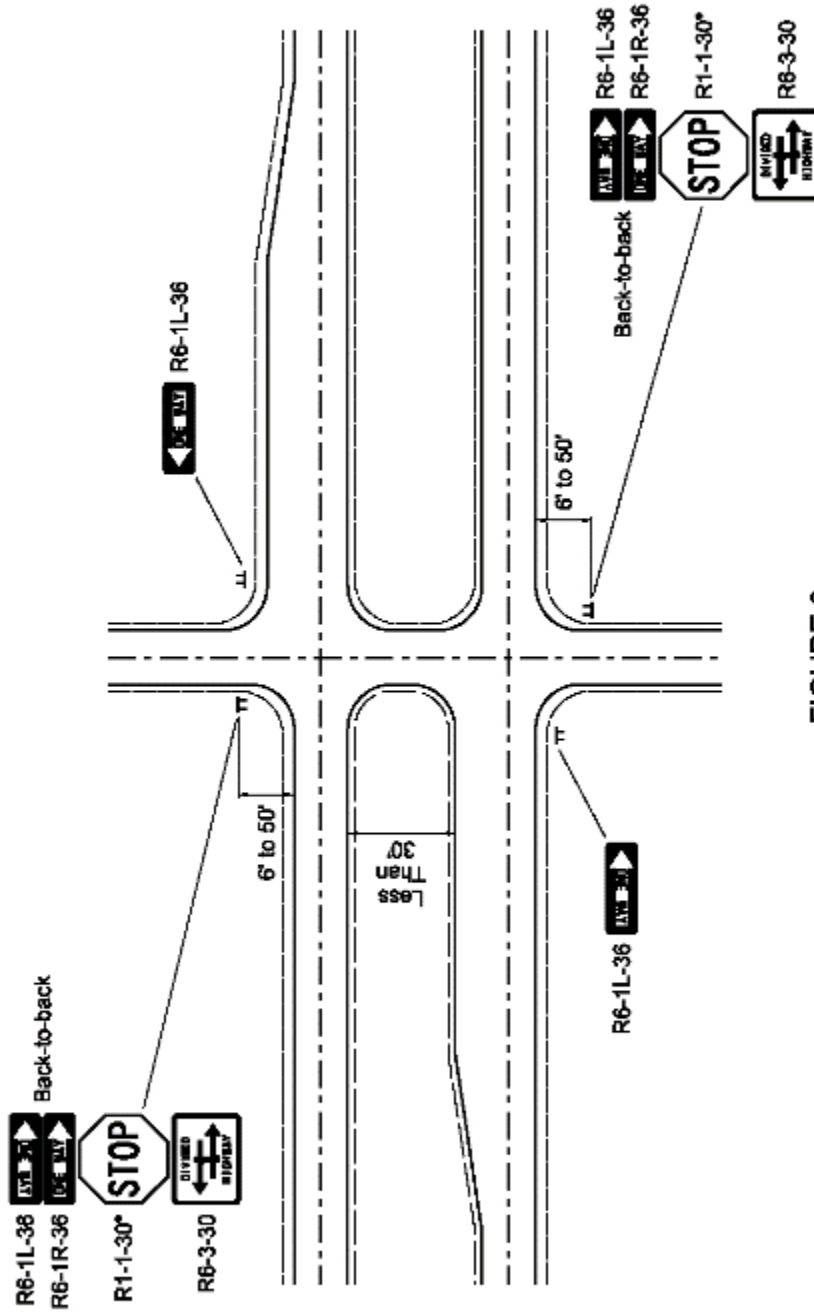


FIGURE 2

\* Where side roads intersect a multilane street or roadway that has a speed of 45 mph or higher, the stop sign shall be a minimum of 36".

Note: Sign sizes shall conform with current MUTCD guidelines

**DIVIDED HIGHWAY - TRAFFIC CONTROL  
(SINGLE APPROACH)  
(WITH TURN LANE)**

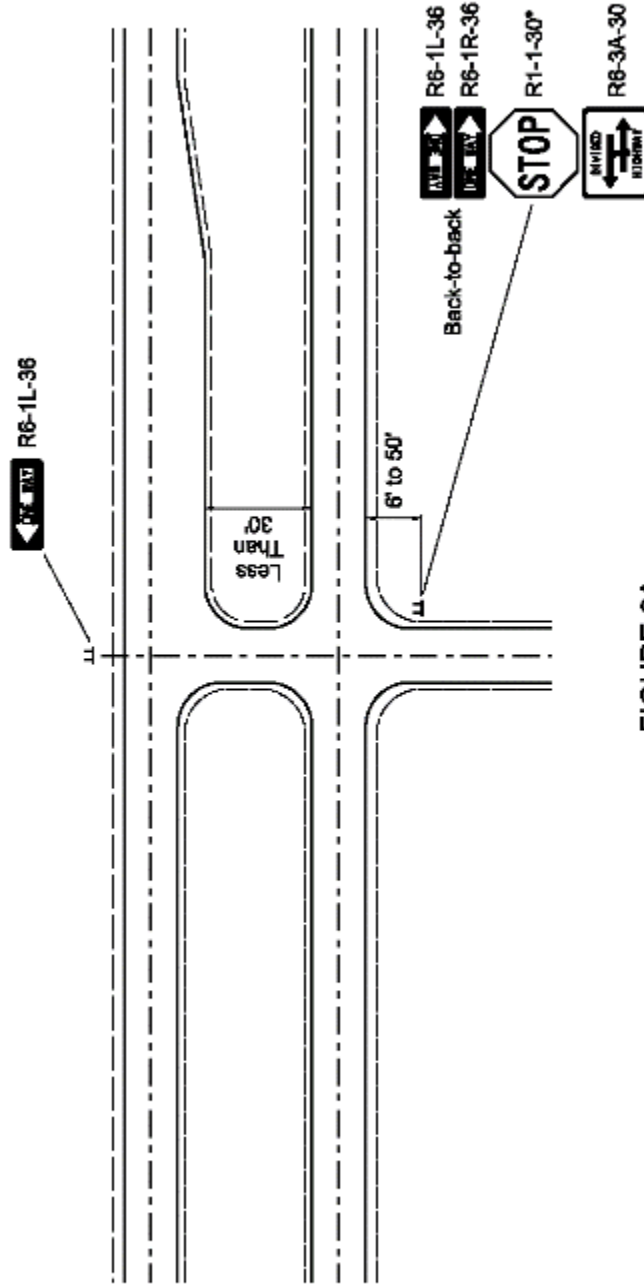


FIGURE 2A

\* Where side roads intersect a multilane street or roadway that has a speed of 45 mph or higher, the stop sign shall be a minimum of 36".

Note: Sign sizes shall conform with current MUTCD guidelines

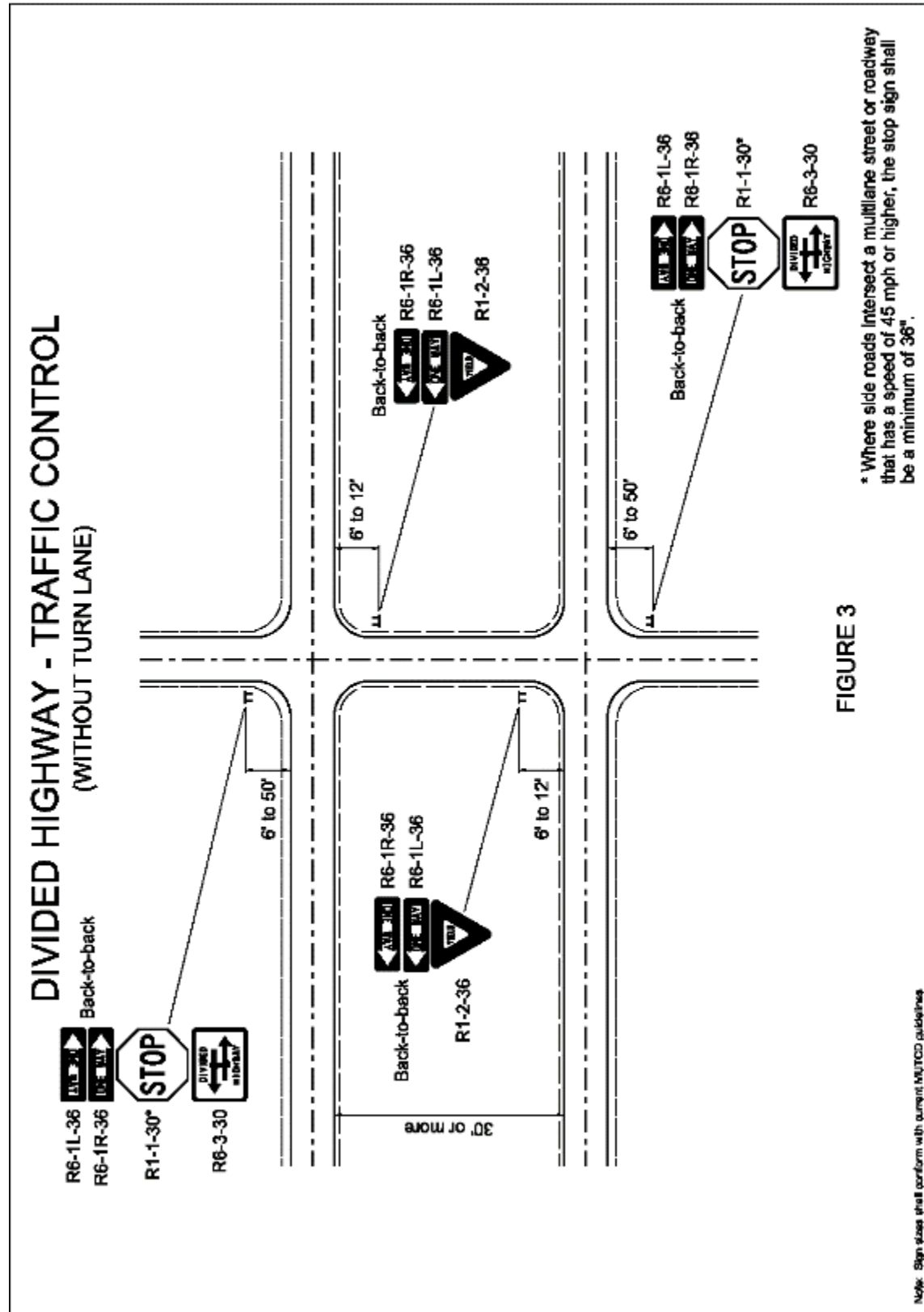
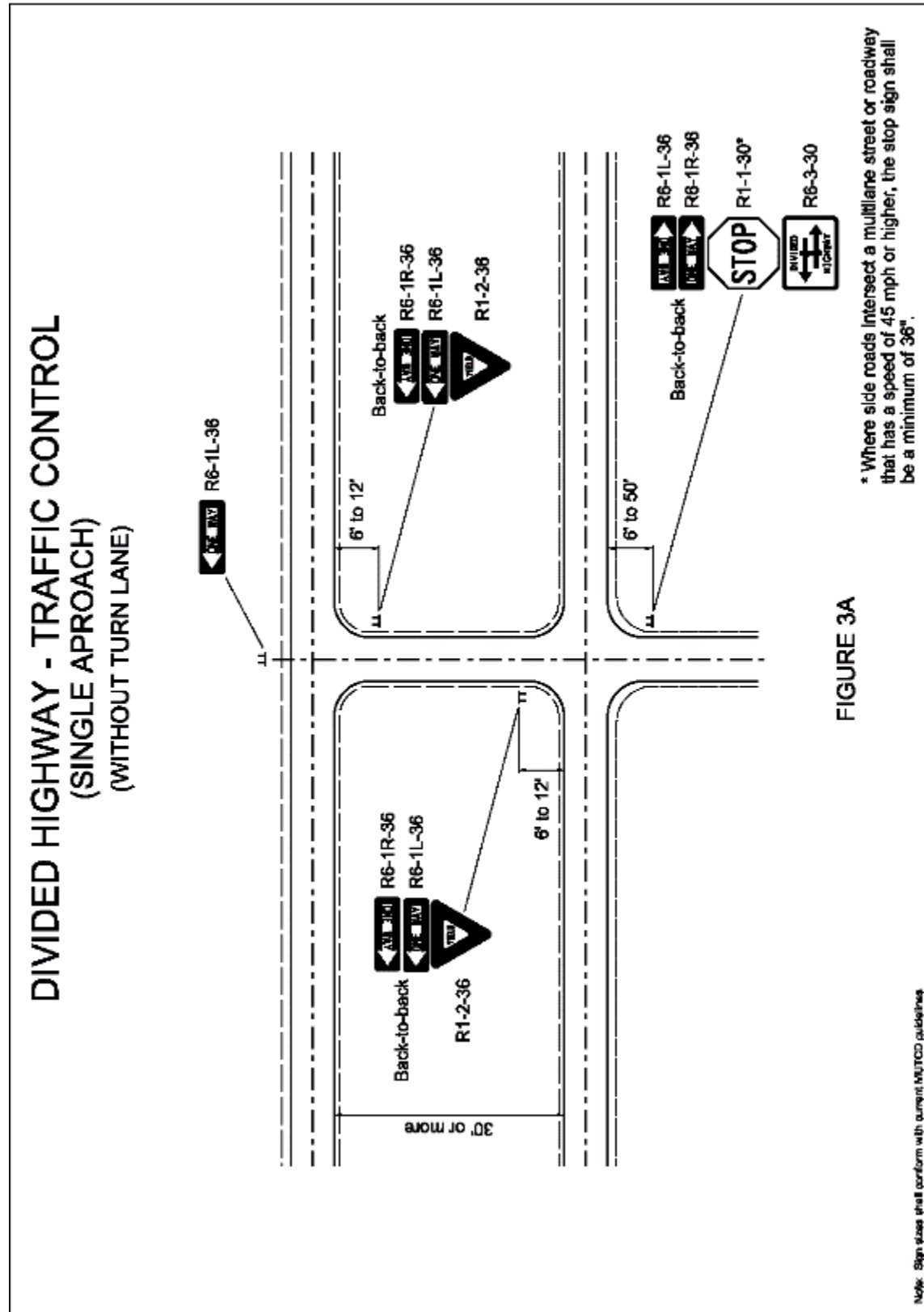
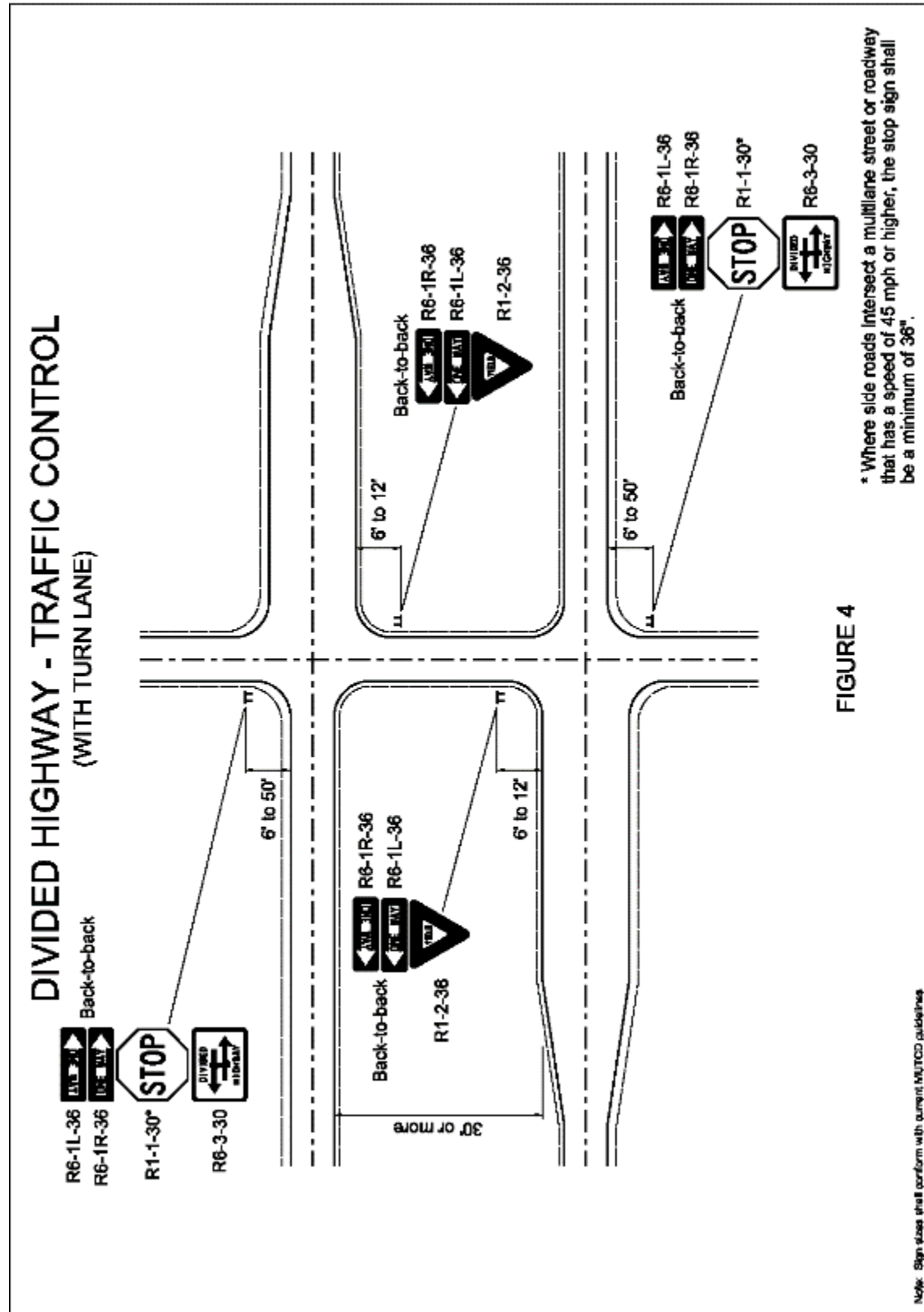
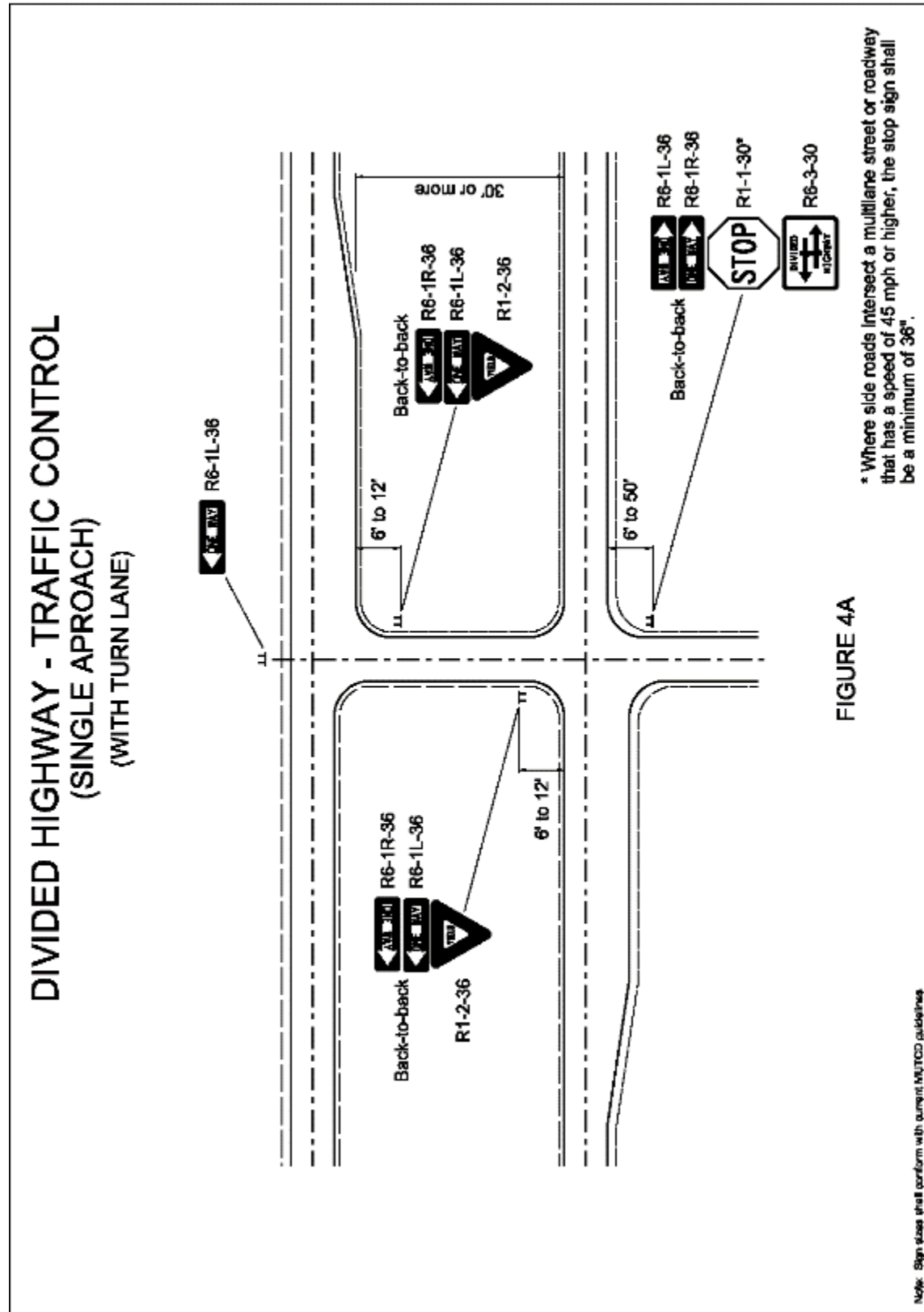


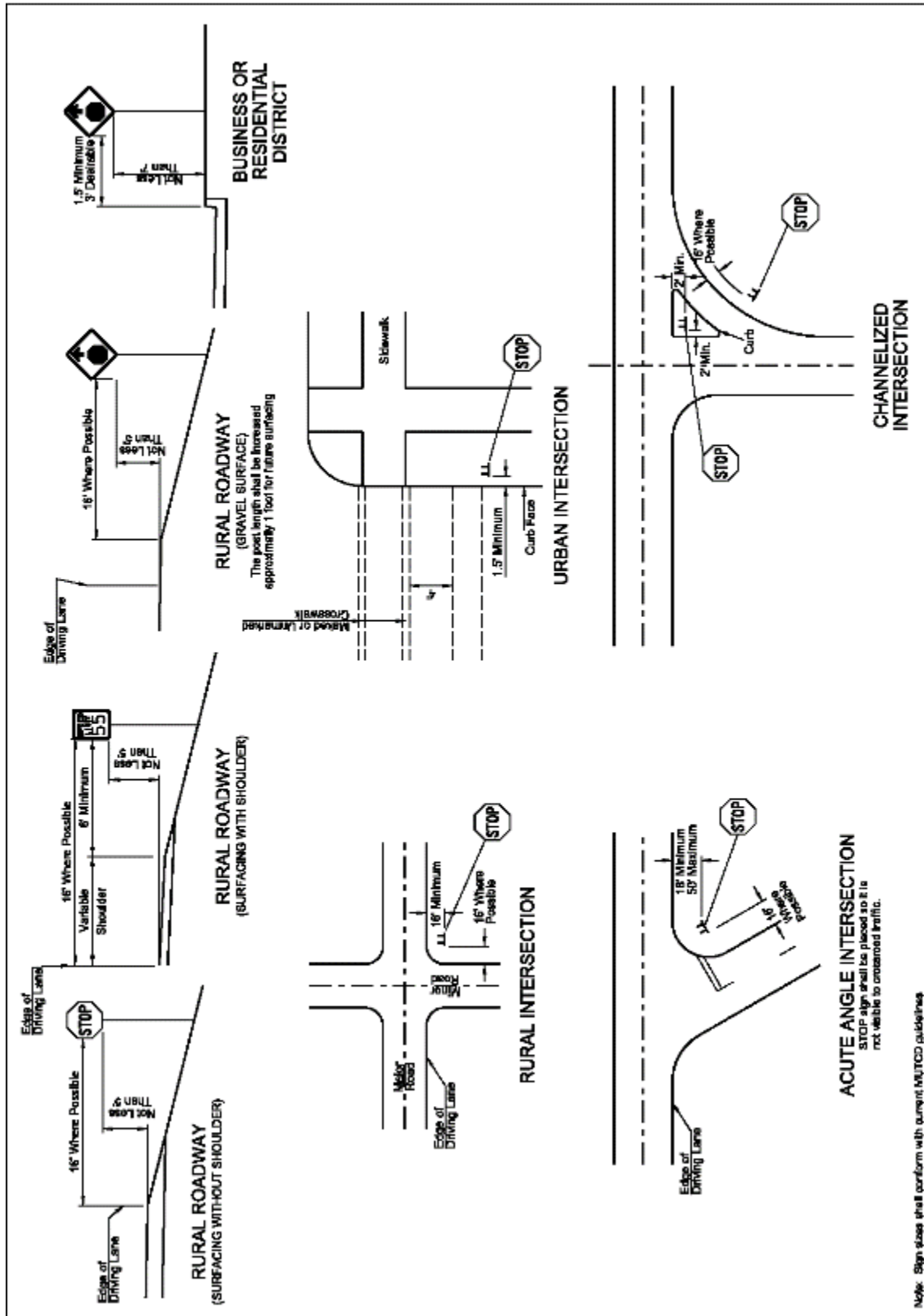
FIGURE 3

\* Where side roads intersect a multilane street or roadway that has a speed of 45 mph or higher, the stop sign shall be a minimum of 36".

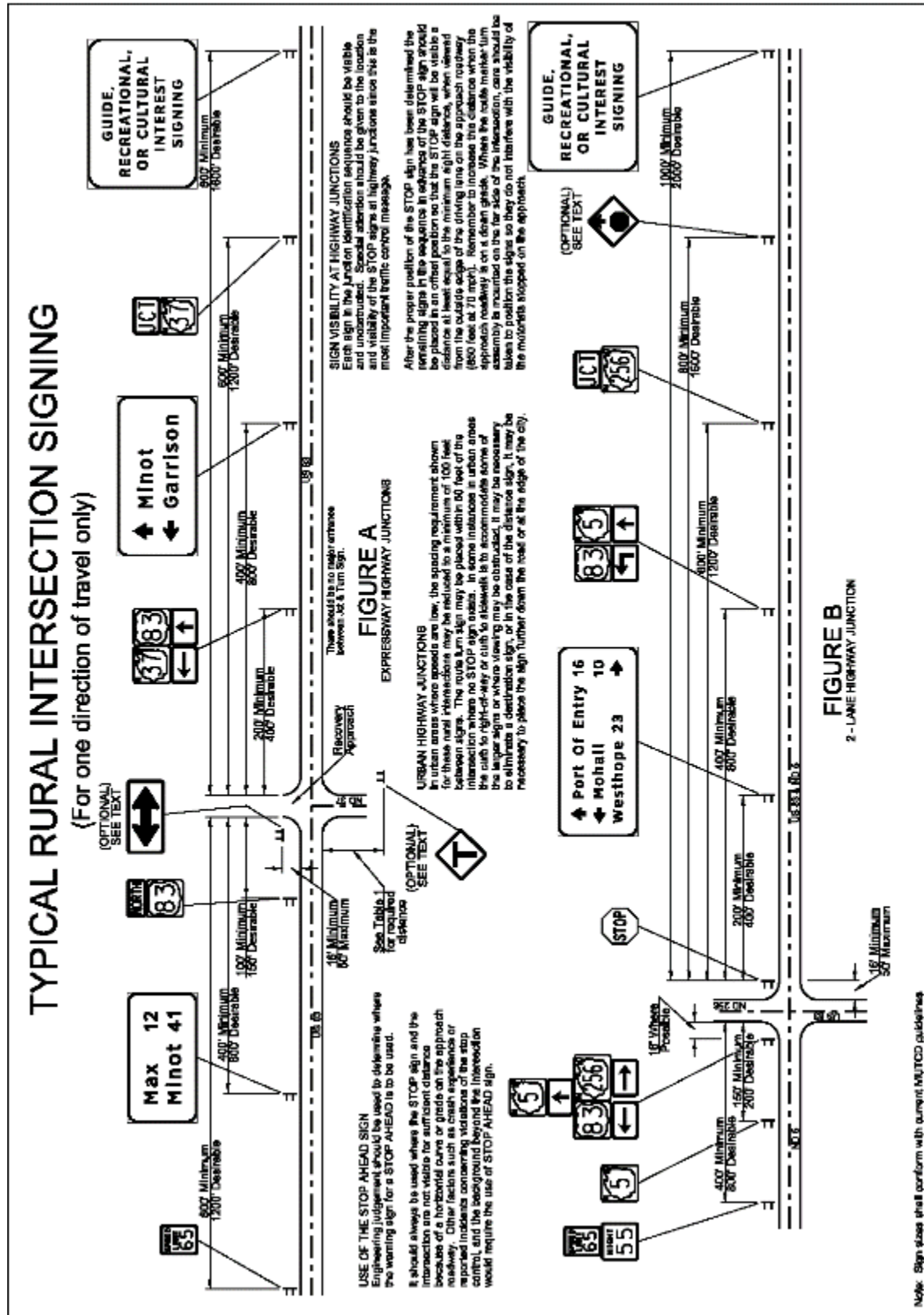


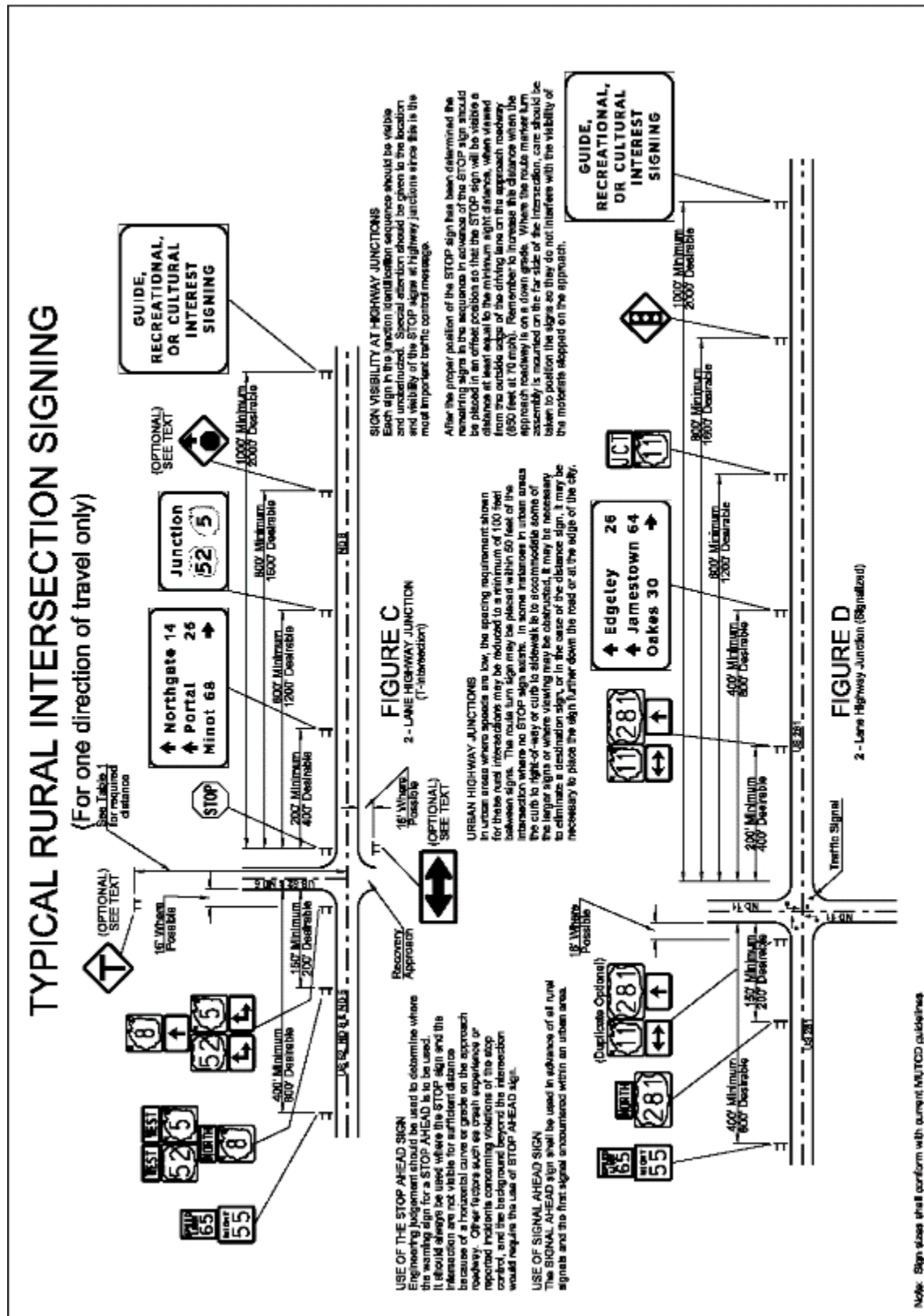






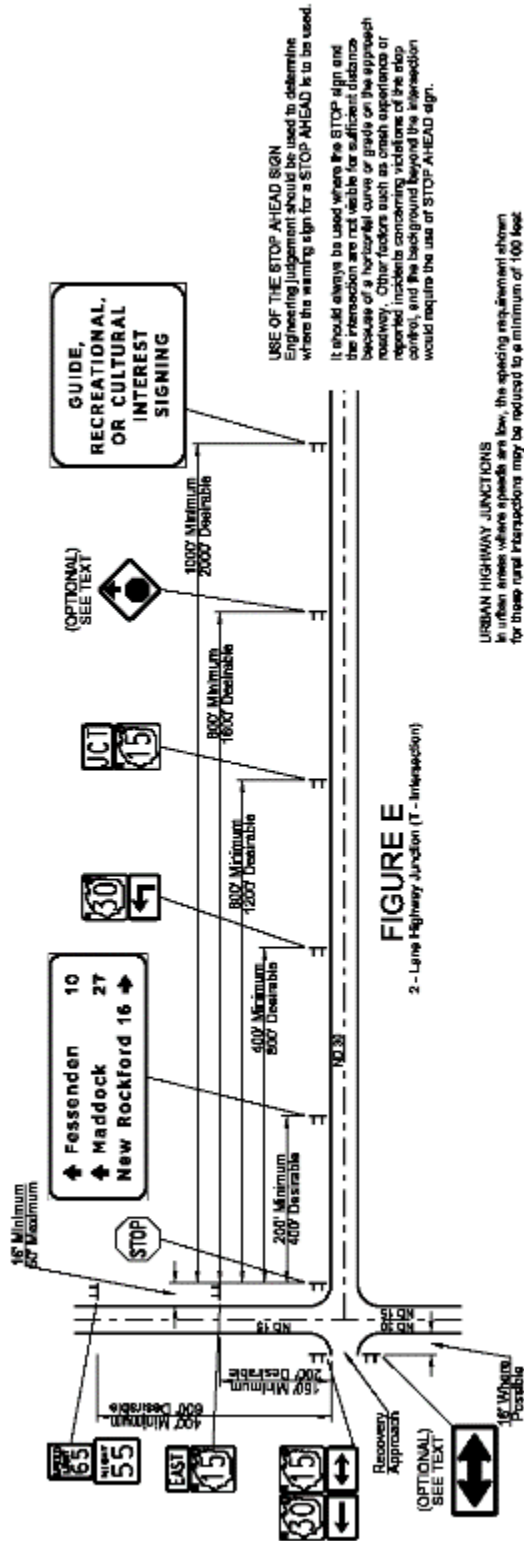






# TYPICAL RURAL INTERSECTION SIGNING

(For one direction of travel only)



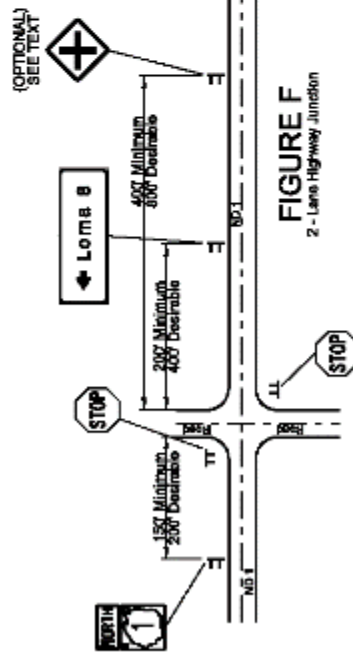
**FIGURE E**  
 2-Lane Highway Junction (T-Intersection)

**URBAN HIGHWAY JUNCTIONS**  
 In urban areas where speeds are low, the spacing requirement shown for these rural intersections may be reduced to a minimum of 100 feet between signs. The route turn sign may be placed within 50 feet of the intersection where the STOP sign exists. In some instances in urban areas the turn to right-of-way or curb to sidewalk is to accommodate some of the larger signs or where viewing may be obstructed, it may be necessary to attribute a destination sign, or in the case of the distance sign, it may be necessary to place the sign further down the road or at the edge of the city.

**SIGN VISIBILITY AT HIGHWAY JUNCTIONS**  
 Each sign in the junction identification sequence should be visible and unobstructed. Special attention should be given to the location and visibility of the STOP signs at highway junctions since this is the most important traffic control message.

After the proper position of the STOP sign has been determined, the remaining signs in the sequence in advance of the STOP sign should be placed in an offset position so that the STOP sign will be visible a distance at least equal to the minimum sight distance, when viewed from the outside edge of the driving lane on the approach roadway (450 feet at 70 mph). Remember to increase this distance when the approach roadway is on a down grade.

Where the route marker lum assembly is mounted on the far side of the intersection, care should be taken to position the signs so they do not interfere with the visibility of the motorist stopped at the approach.

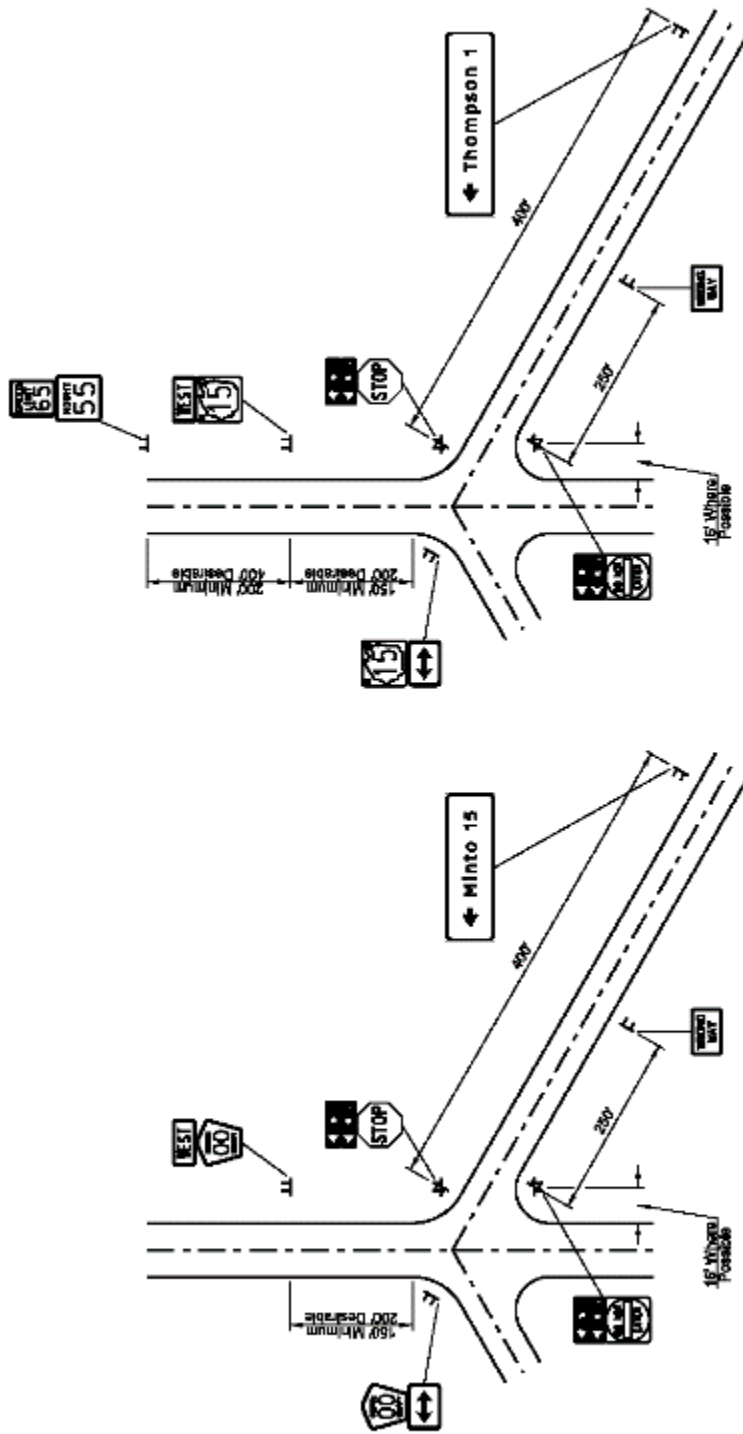


**FIGURE F**  
 2-Lane Highway Junction

Note: Sign sizes shall conform with current MUTCD guidelines

# TYPICAL RAMP TERMINAL SIGNING

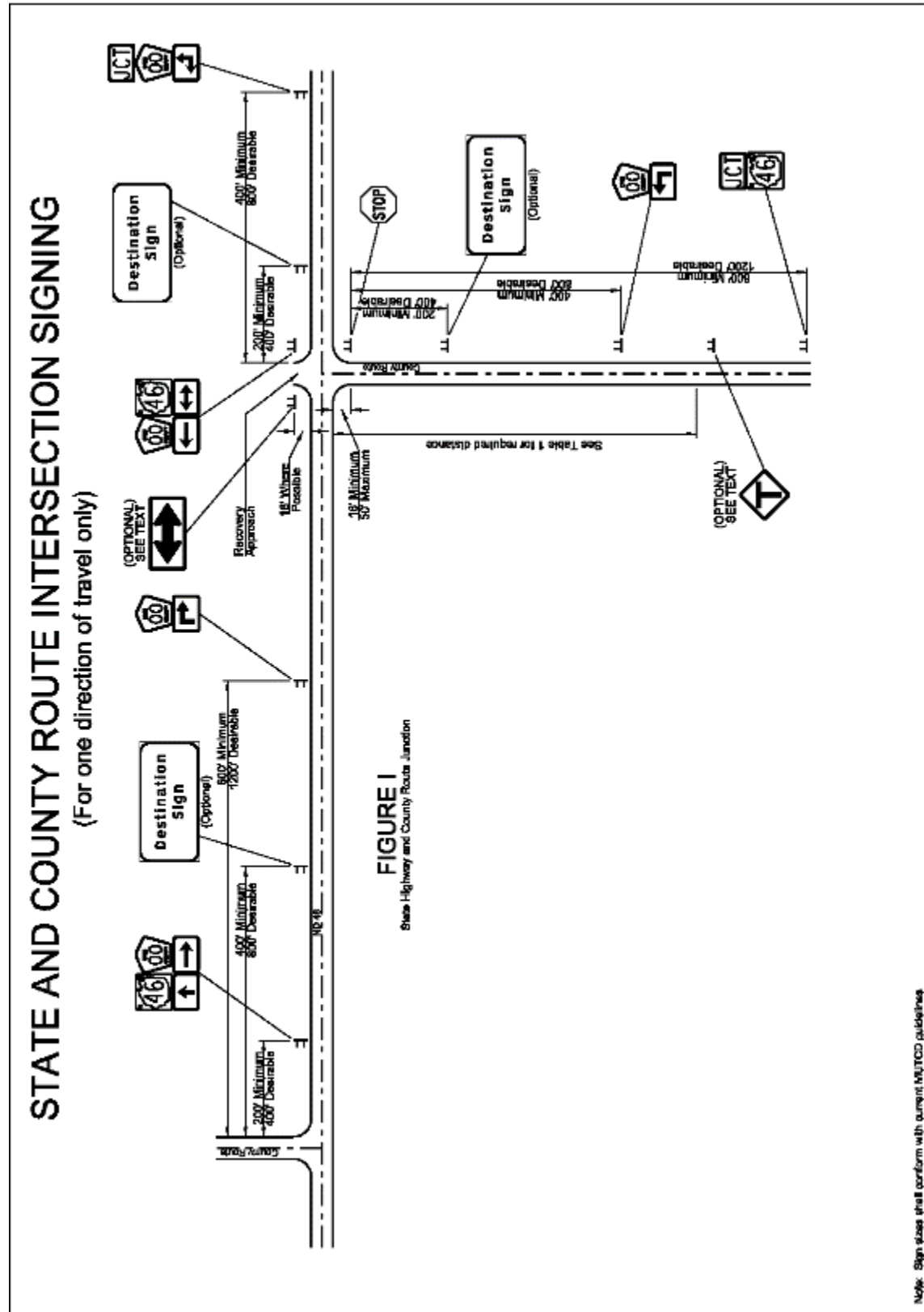
(For one direction of travel only)



**FIGURE H**  
Ramp Junction  
with State or US Route

**FIGURE G**  
Ramp Junction  
with County Route

Note: Sign sizes shall conform with current MUTCD guidelines



# STATE AND COUNTY ROUTE SIGNING AT COMPLEX INTERSECTION

State Highway and County Route Junction

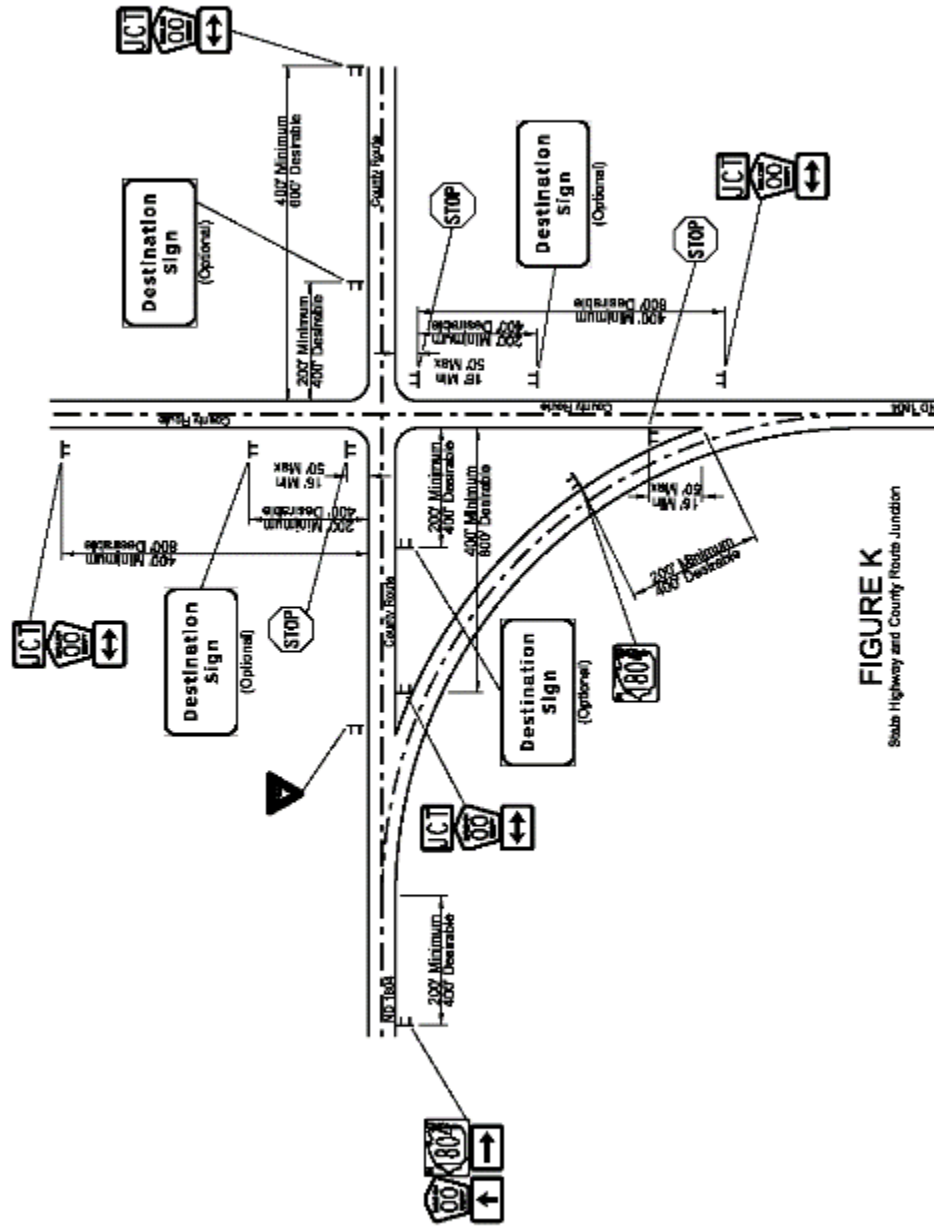
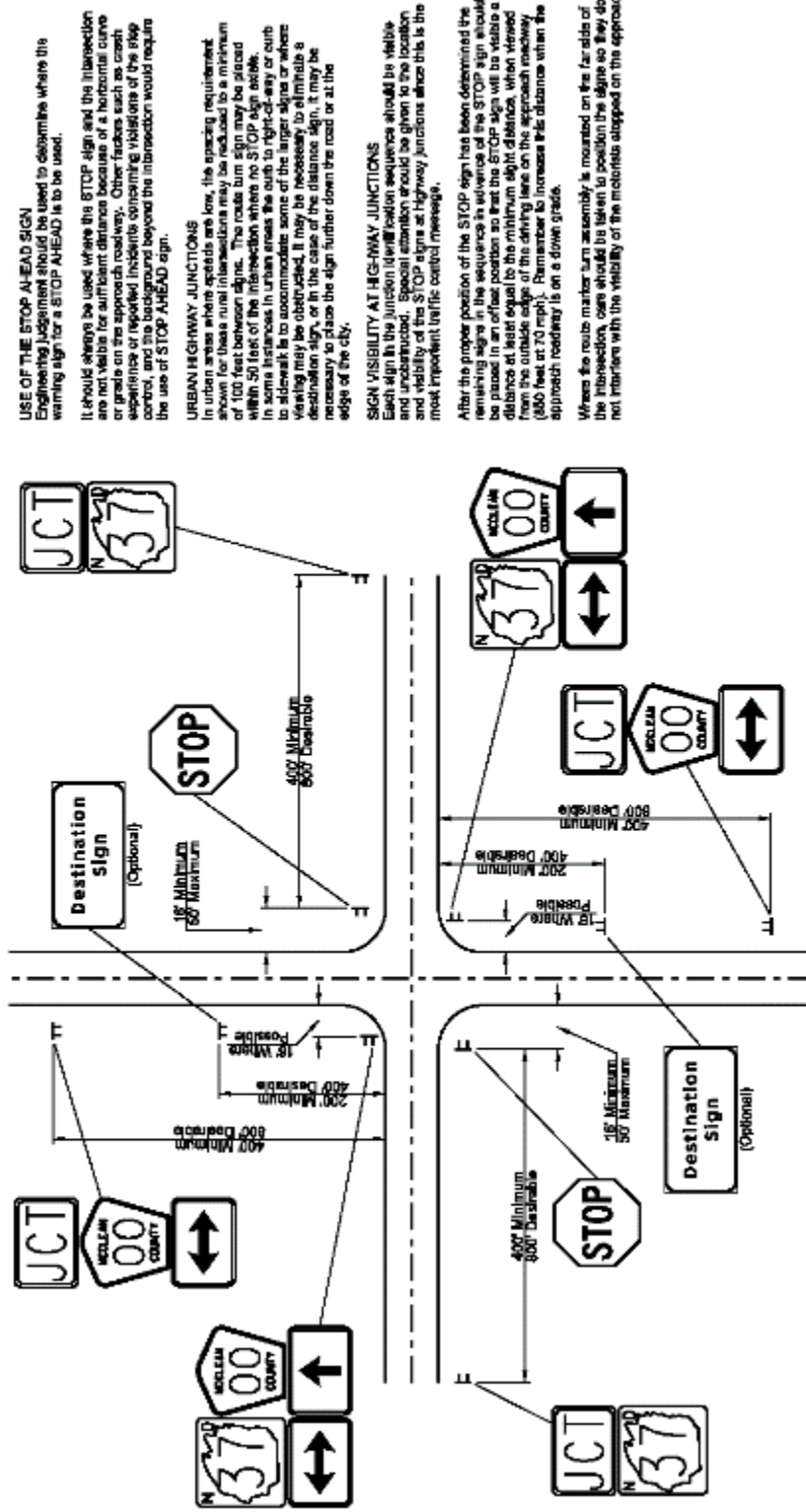


FIGURE K  
State Highway and County Route Junction

Note: Sign sizes shall conform with current MUTCD guidelines



# STATE AND COUNTY ROUTE AT TWO WAY STOP INTERSECTION



**USE OF THE STOP AHEAD SIGN**  
Engineering judgement should be used to determine where the warning sign for a STOP AHEAD is to be used.

It should always be used where the STOP sign and the intersection are not visible for sufficient distance because of a horizontal curve or grade on the approach roadway. Other factors such as crash experience or reported incidents concerning violations of the stop control, and the background beyond the intersection would require the use of STOP AHEAD sign.

**URBAN HIGHWAY JUNCTIONS**  
In urban areas where speeds are low, the spacing requirement between signs is reduced. The route turn sign may be placed within 50 feet of the intersection where no STOP sign exists. In some instances in urban areas the curb to right-of-way or curb to sidewalk is to accommodate some of the larger signs or where viewing may be obstructed, it may be necessary to eliminate a destination sign, or in the case of the distance sign, it may be necessary to place the sign further down the road or at the edge of the city.

**SIGN VISIBILITY AT HIGHWAY JUNCTIONS**  
Each sign in the junction identification sequence should be visible and unobstructed. Special attention should be given to the location and visibility of the STOP sign at Highway Junctions since this is the most important traffic control message.

After the proper position of the STOP sign has been determined the remaining signs in the sequence in advance of the STOP sign should be placed in an offset position so that the STOP sign will be visible a distance at least equal to the minimum sight distance, when viewed from the outside edge of the driving lane on the approach roadway (600 feet or 70 mph). Rearranging to increase this distance when the approach roadway is on a down grade.

When the route marker turn assembly is mounted on the far side of the intersection, care should be taken to position the signs so they do not interfere with the visibility of the motorist stopped on the approach.

FIGURE L

Note: Sign sizes shall conform with current MUTCD guidelines

# STATE AND COUNTY ROUTE AT-T-TYPE INTERSECTIONS

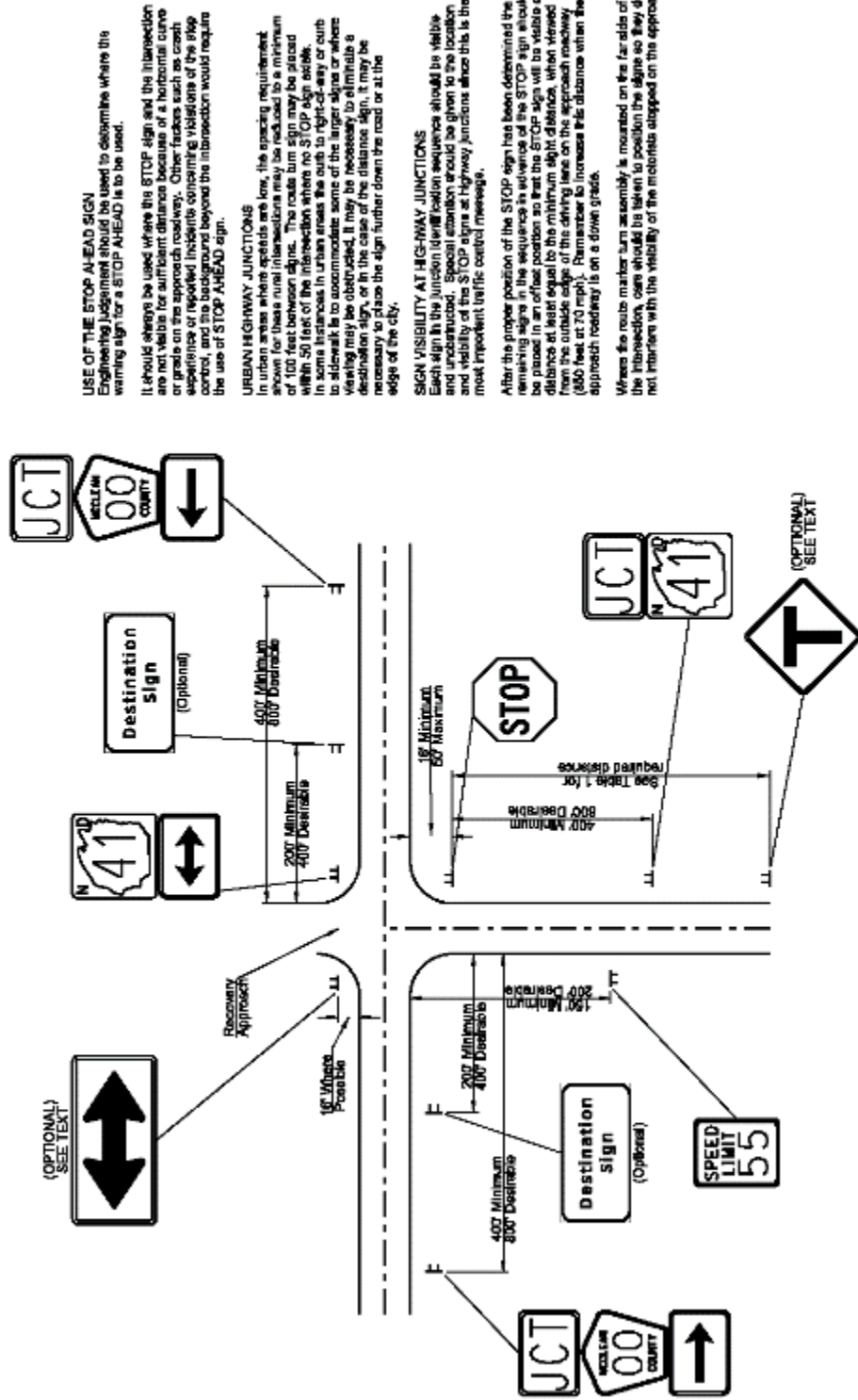


FIGURE M

**USE OF THE STOP AHEAD SIGN**  
Engineering judgement should be used to determine where the warning sign for a STOP AHEAD is to be used.  
It should always be used where the STOP sign and the intersection are not visible for sufficient distance because of a horizontal curve or grade on the approach roadway. Other factors such as crash experience or reported incidents concerning violations of the stop control, and the background beyond the intersection would require the use of STOP AHEAD sign.

**URBAN HIGHWAY JUNCTIONS**  
In urban areas where speeds are low, the spacing requirement between the STOP sign and the intersection may be a minimum of 100 feet before signs. The route turn sign may be placed within 50 feet of the intersection where no STOP sign exists. In some instances in urban areas the curb to right-of-way or curb to sidewalk is to accommodate some of the larger signs or where viewing may be obstructed. It may be necessary to eliminate a destination sign, or in the case of the distance sign, it may be necessary to place the sign further down the road or at the edge of the city.

**SIGN VISIBILITY AT HIGHWAY JUNCTIONS**  
Each sign in the junction identification sequence should be visible and unobstructed. Special attention should be given to the location and visibility of the STOP sign at Highway Junctions since this is the most important traffic control message.

After the proper position of the STOP sign has been determined the remaining signs in the sequence in advance of the STOP sign should be placed in an offset position so that the STOP sign will be visible a distance at least equal to the minimum sight distance, when viewed from the outside edge of the driving lane on the approach roadway (800 feet or 70 mph). Remember to increase this distance when the approach roadway is on a down grade.

When the route marker turn assembly is mounted on the far side of the intersection, care should be taken to position the signs so they do not interfere with the visibility of the motorist stopped on the approach.

Note: Sign sizes shall conform with current MUTCD guidelines



# STATE AND COUNTY ROUTE OR TWP ROAD SIGNING AT RADIAL "T" INTERSECTION

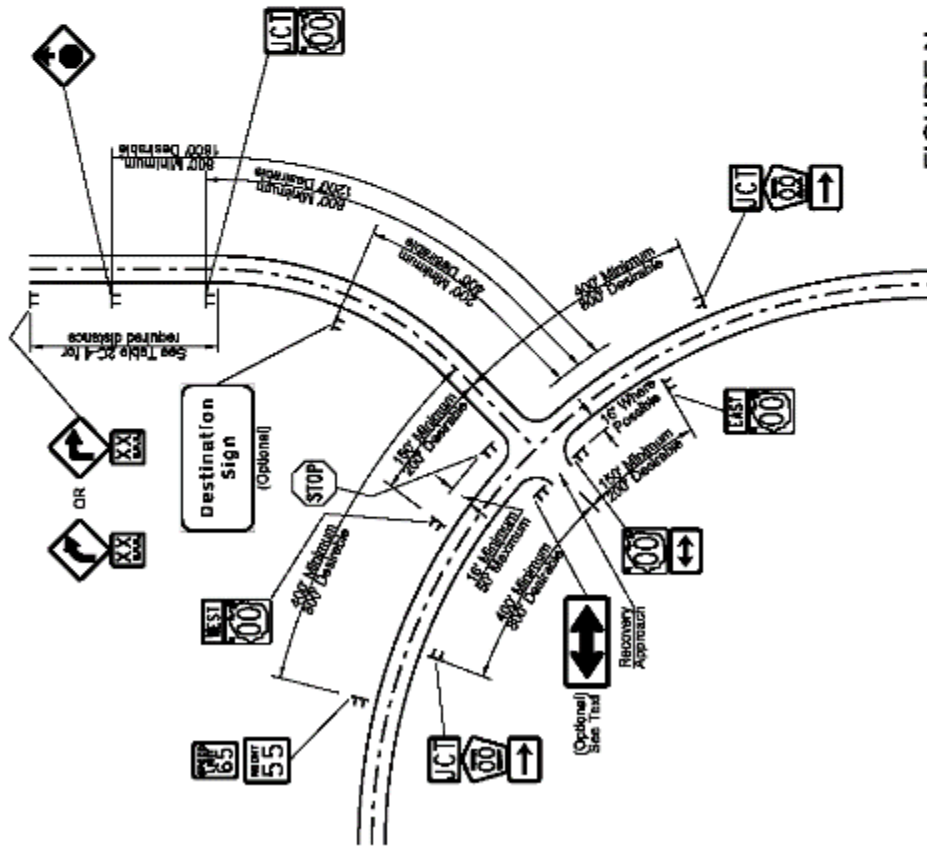


FIGURE N

**USE OF THE STOP AHEAD SIGN**  
Engineering judgement should be used to determine where the warning sign for a STOP AHEAD is to be used.  
It should always be used where the STOP sign and the intersection are not visible for sufficient distance because of a horizontal curve or grade on the approach roadway. Other factors such as crash experience or reported incidents concerning violations of the stop control, and the background beyond the intersection would require the use of STOP AHEAD sign.

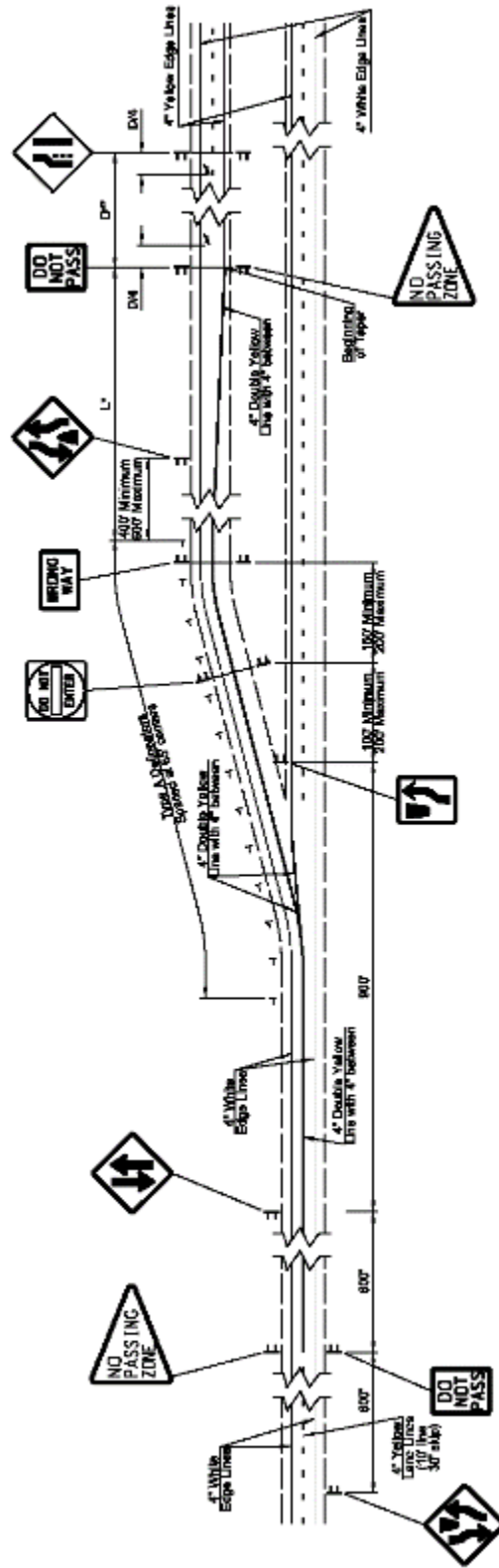
**URBAN HIGHWAY JUNCTIONS**  
In urban areas where speeds are low, the spacing requirement for advance warning signs is reduced. The route turn sign may be placed within 50 feet of the intersection where no STOP sign exists. In some instances, in urban areas the curb to right-of-way or curb to sidewalk is to accommodate some of the larger signs or where viewing may be obstructed. It may be necessary to eliminate a destination sign, or in the case of the distance sign, it may be necessary to place the sign further down the road or at the edge of the city.

**SIGN VISIBILITY AT HIGHWAY JUNCTIONS**  
Each sign in the junction identification sequence should be visible and unobstructed. Special attention should be given to the location and visibility of the STOP sign at Highway Junctions since this is the most important traffic control message.

After the proper position of the STOP sign has been determined the remaining signs in the sequence in advance of the STOP sign should be placed in an offset position so that the STOP sign will be visible a distance at least equal to the minimum sight distance, which varies from the outside edge of the driving lane on the approach roadway (600 feet or 70 mps). Reference to increase this distance when the approach roadway is on a down grade.  
Where the route marker turn assembly is mounted on the far side of the intersection, care should be taken to position the signs so they do not interfere with the visibility of the motorist stopped on the approach.

Note: Sign sizes shall conform with current MUTCD guidelines

# ROADWAY TRANSITIONS DIVIDED ROADWAY TO TWO-WAY TWO LANE



\* L=WS for speeds of 45 mph or greater and L=WS/80 for speeds of less than 45 mph

\*\*See Guidelines for Advance Placement of Warning Signs Table in the MUTCD

FIGURE O

Note: Sign above shall conform with current MUTCD guidelines

## CLIMBING LANE SIGNING AND MARKING

Barrier Stripe Length					
Speed Limit (S)	30	40	50	60	65
Minimum Length	200'	300'	450'	650'	750'

**Note:**  
The climbing lane area may have some no passing zone restrictions because of site distance. The climbing lane areas should be checked for no passing areas and should have the downhill side marked where there is no passing.

Lane-reduction arrows are optional for speeds of less than 45 mph.

- L = WS for speeds of 45 mph or greater and  $L = WS/60$  for speeds of less than 45 mph (feet)
- W = Offset (feet)
- S = Posted Speed, 85th - percentile or statutory speed (mph)
- D = Advance warning distance (feet)\*

\*See Guidelines for Advance Placement of Warning Signs Table in the MUTCD

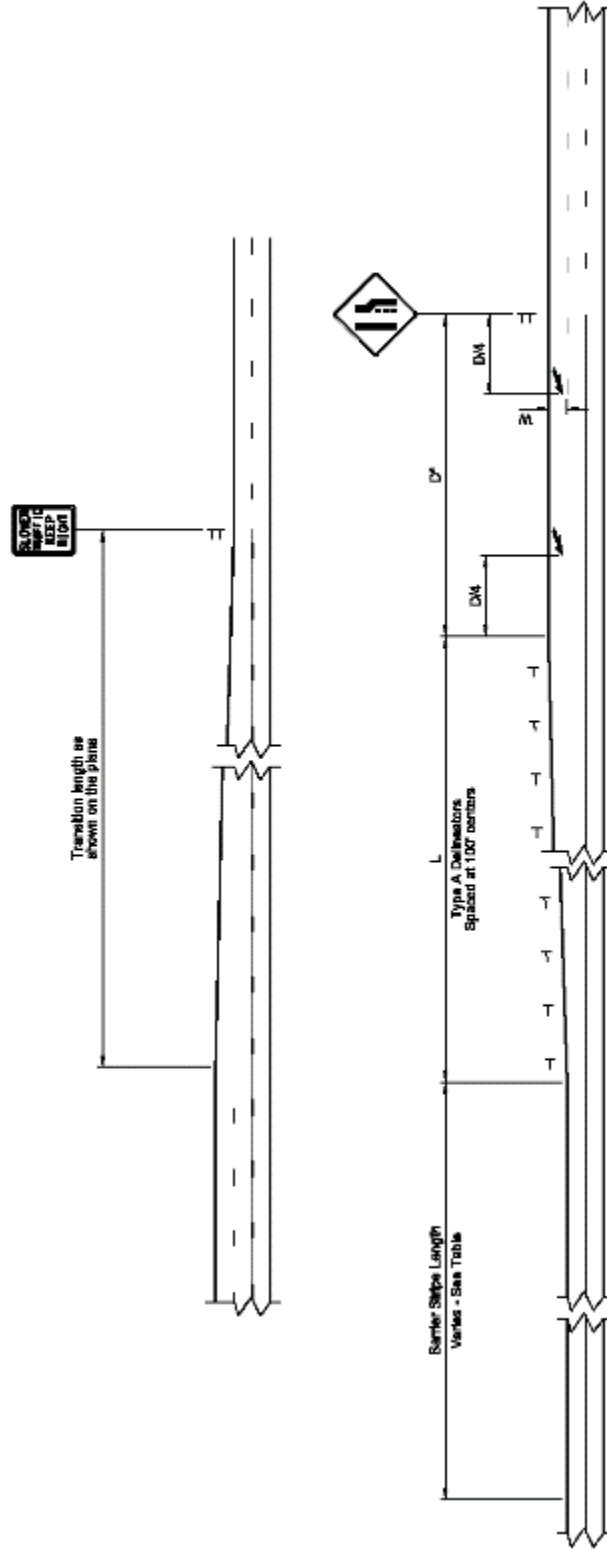


FIGURE P

Note: Sign sizes shall conform with current MUTCD guidelines

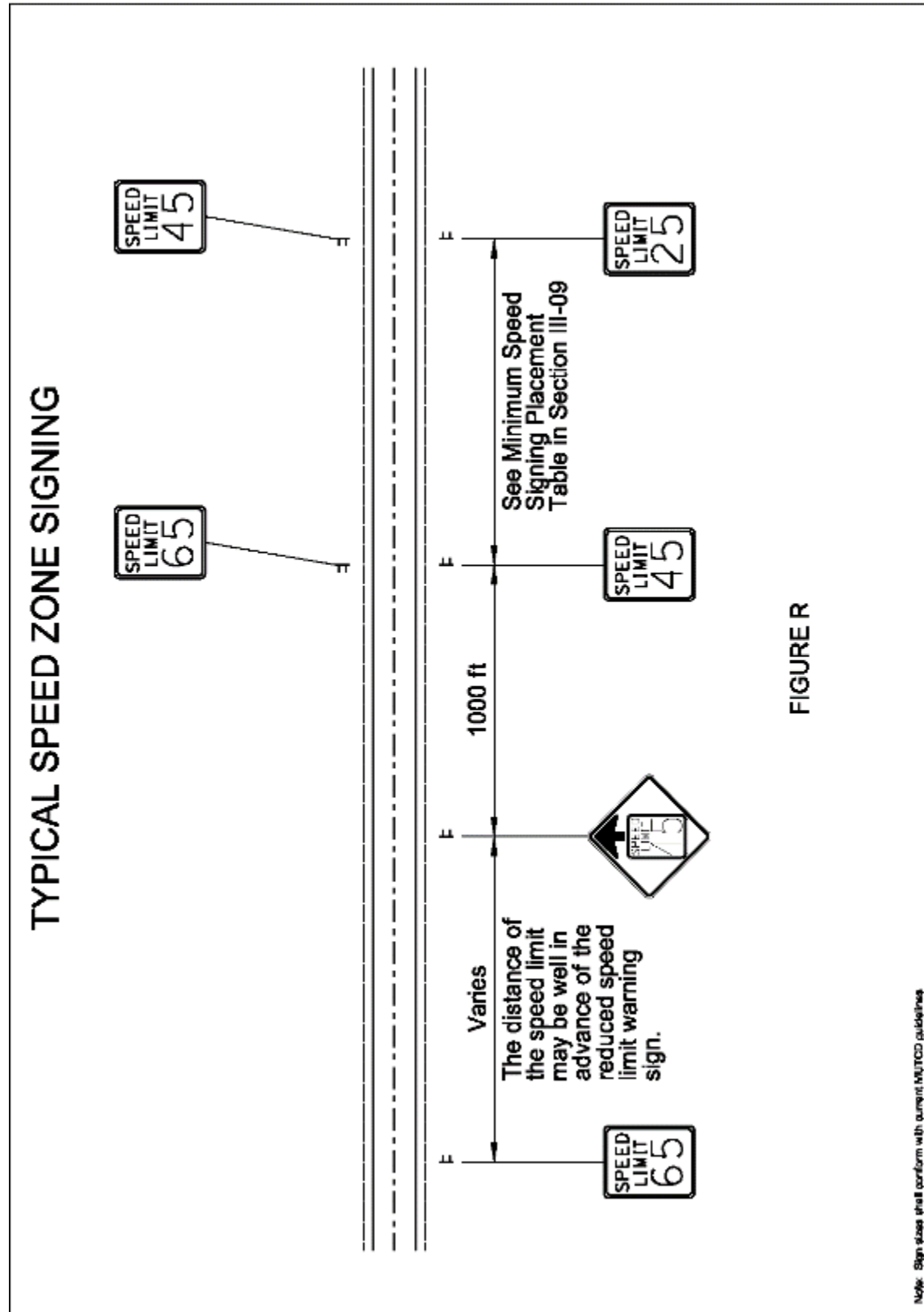
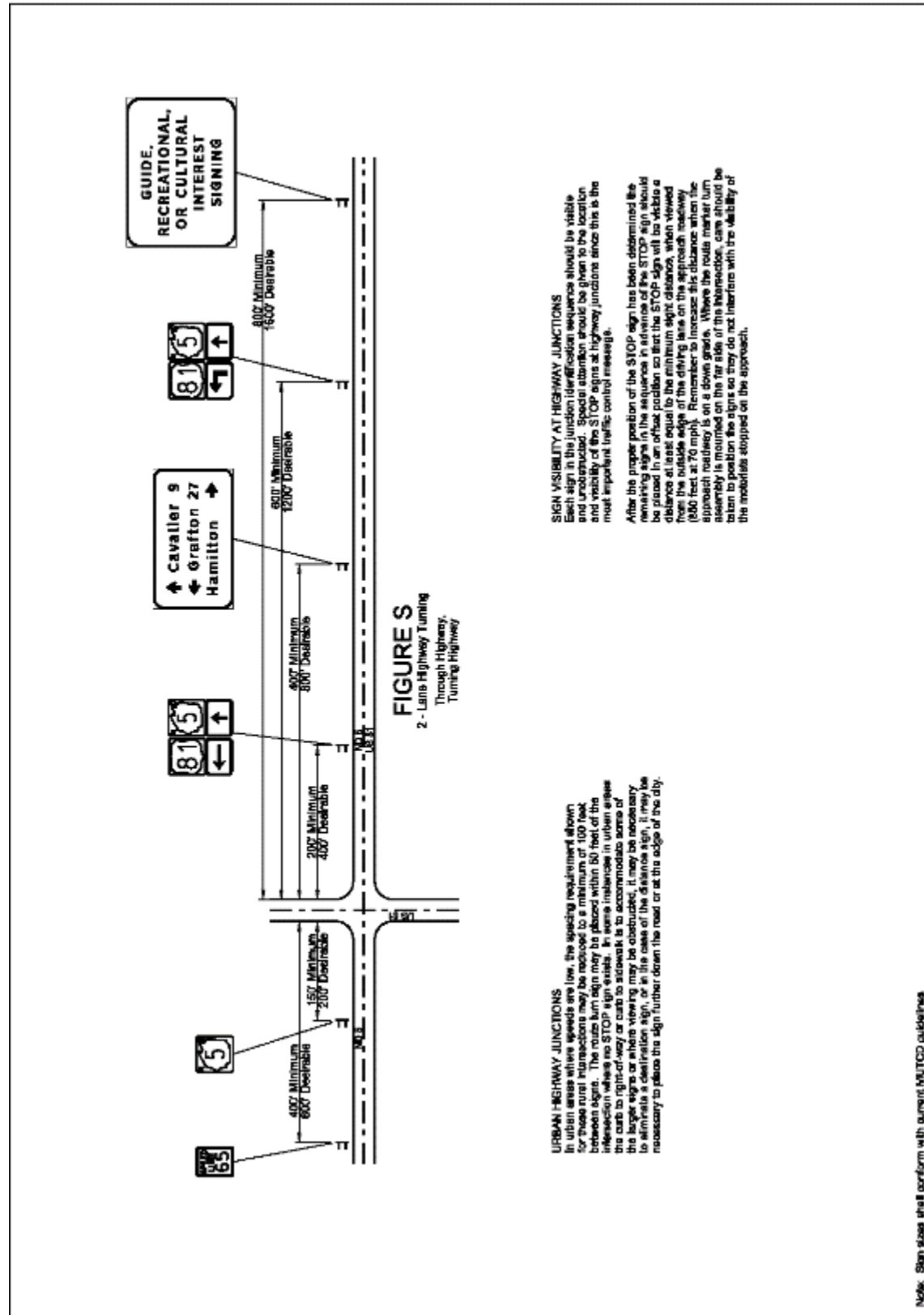


FIGURE R

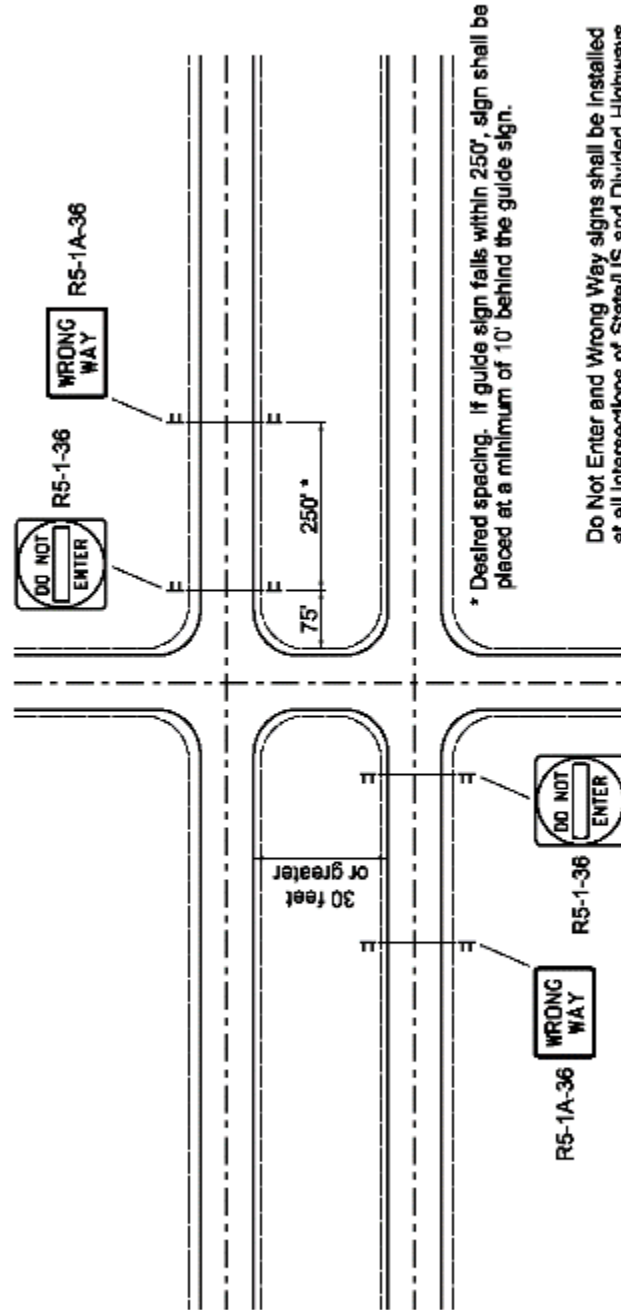


**URBAN HIGHWAY JUNCTIONS**  
In urban areas where speeds are low, the spacing requirements shown for these rural intersections may be reduced to a minimum of 100 feet between signs. The route marker sign may be placed within 50 feet of the intersection where no STOP sign exists. In some instances in urban areas the curb to right-of-way or curb to sidewalk is to accommodate some of the larger signs or where viewing may be obstructed, it may be necessary to minimize a distance sign. In the case of the distance sign, it may be necessary to place the sign further down the road or at the edge of the city.

**SIGN VISIBILITY AT HIGHWAY JUNCTIONS**  
Each sign in the junction identification sequence should be visible and unobstructed. Special attention should be given to the location and visibility of the STOP sign at highway junctions since this is the most important traffic control message.  
After the proper position of the STOP sign has been determined the remaining signs in the junction identification sequence should be placed in the same offset as the STOP sign. The STOP sign should be placed at least equal to the minimum sight distance when viewed from the outside edge of the driving lane on the approach roadway (800 feet at 70 mph). Remember to increase this distance when the approach roadway is on a down grade. Where the route marker turn assembly is mounted on the far side of the intersection, care should be taken to position the signs so they do not interfere with the visibility of the motorists stopped on the approach.

Note: Sign sizes shall conform with current MUTCD guidelines

# DO NOT ENTER AND WRONG WAY SIGNS



\* Desired spacing. If guide sign falls within 250', sign shall be placed at a minimum of 10' behind the guide sign.

Do Not Enter and Wrong Way signs shall be installed at all intersections of State/US and Divided Highways.

Do Not Enter signs may be installed at intersections of Local Roads (County/Township) if the AADT on the Local Road exceeds 250 or if there have been two or more crashes in three years related to a vehicle turning the wrong way onto the Divided Highway.

Wrong Way signs may be installed to supplement the Do Not Enter signs at intersections of Local Roads and Divided Highways when the AADT exceeds 500 or if crash problems persist.

FIGURE T

Note: Sign sizes shall conform with current MUTCD guidelines

NORTH DAKOTA DEPARTMENT OF TRANSPORTATION

INTERCHANGE NUMBERING ON I-94

April 2001

<u>Interchange Name</u>	<u>Reference Point</u>	<u>Exit No.</u>	<u>Interchange Classification</u>
Beach	1.849	1	Intermediate
Boys Ranch	7.368	7	Intermediate
Sentinel Butte	10.478	10	Intermediate
Buffalo Gap	18.452	18	Minor
West River Road	23.001	23	Minor
West Medora	24.315	24	Intermediate
East Medora	27.243	27	Intermediate
Painted Canyon	32.963	32	Intermediate
Fryberg	36.861	36	Intermediate
Belfield	42.366	42	Major B
South Heart	51.476	51	Intermediate
West Dickinson	59.485	59	Major B
ND 22	61.476	61	Major B
East Dickinson	64.204	62	Major B
Gladstone	72.253	72	Intermediate
Taylor	78.901	78	Intermediate
ND 8	84.885	84	Major B

<u>Interchange Name</u>	<u>Reference Point</u>	<u>Exit No.</u>	<u>Interchange Classification</u>
Antelope	90.110	90	Minor
Hebron	97.188	97	Intermediate
Eagles Nest	102.914	102	Intermediate
Glen Ullin	108.354	108	Intermediate
ND 49	110.367	110	Intermediate
Geck Township	113.389	113	Minor
Dengate	117.197	117	Minor
Bluegrass	120.204	120	Minor
Almont	123.200	123	Intermediate
ND 31	127.662	127	Intermediate
Judson	134.115	134	Intermediate
Sweet Briar	140.148	140	Minor
ND 25	147.183	147	Major B
Northwest Mandan	152.329	152	Major B
Refinery Road	153.988	153	Intermediate
West Midway	155.026	155	Major B
East Midway	156.069	156	Major B
Ward Road	157.344	157	Major B



<u>Interchange Name</u>	<u>Reference Point</u>	<u>Exit No.</u>	<u>Interchange Classification</u>
U.S. 83	159.419	159	Major B
East Bismarck	161.439	161	Major B
Menoken	170.519	170	Intermediate
McKenzie	176.501	176	Intermediate
Sterling	182.488	182	Major B
Driscoll	190.110	190	Intermediate
Long Lake	195.090	195	Minor
ND 3	200.760	200	Major B
Robinson	205.071	205	Minor
ND 3	208.702	208	Major B
Tappen	214.126	214	Intermediate
Pettibone	217.145	217	Intermediate
Crystal Springs	221.733	221	Intermediate
Streeter	228.321	228	Intermediate
Medina	230.288	230	Intermediate
Halfway Lake	233.343	233	Minor
Cleveland	238.793	238	Intermediate
Windsor	242.672	242	Intermediate
Oswego	245.191	245	Minor

<u>Interchange Name</u>	<u>Reference Point</u>	<u>Exit No.</u>	<u>Interchange Classification</u>
Lippert Township	248.991	248	Minor
Eldridge	251.686	251	Intermediate
Woodbury Township	256.224	256	Intermediate
West Jamestown crossover	257.002	257	Intermediate
US 281	258.055	258	Intermediate
Southeast Jamestown	260.125	260	Intermediate
Bloom	262.361	262	Intermediate
Spiritwood	269.355	269	Intermediate
Urbana	272.369	272	Minor
Eckelson	276.385	276	Intermediate
Sandborn	281.640	281	Intermediate
Rogers	283.139	283	Intermediate
Oakes	288.636	288	Intermediate
West Valley City	290.803	290	Intermediate
Kathryn	292.072	292	Intermediate
East Valley City	294.283	294	Intermediate
Peak	296.741	296	Minor
Cuba	298.746	298	Minor
ND 32	302.712	302	Major B

<u>Interchange Name</u>	<u>Reference Point</u>	<u>Exit No.</u>	<u>Interchange Classification</u>
Tower City	307,679	307	Intermediate
Hill Township	310.456	310	Minor
ND 38	314.863	314	Major B
Ayr	317.846	317	Intermediate
Emden	320.837	320	Intermediate
Absaraka	322.827	322	Intermediate
Wheatland	324.821	324	Intermediate
Lynchburg	328.710	328	Minor
Casselton	331.226	331	Major B
Mapleton	338.737	338	Intermediate
Kindred	340.717	340	Intermediate
Raymond	342.721	342	Intermediate
West Fargo	343.803	343	Major B
Horace Road	346.442	346	Intermediate
45 <sup>th</sup> Street	348.581	348	Intermediate
Jct. I-94 & I-29	349.584	349	Major A
25 <sup>th</sup> Street	350.586	350	Intermediate
US 81	351.590	351	Major B

**NORTH DAKOTA DEPARTMENT OF TRANSPORTATION**

**INTERCHANGE NUMBERING ON I-29**

April 2001

<u>Exit No</u>	<u>Interchange Name</u>	<u>Reference Point</u>	<u>Interchange Classification</u>
1	State Line	0.013	Intermediate
2	Lamars	2.074	Minor
8	ND 11	8.073	Intermediate
15	Great Bend	15.079	Intermediate
23	ND 13	22.583	Intermediate
26	Dwight	26.030	Minor
31	Galchutt	31.038	Intermediate
37	Colfax	37.047	Intermediate
42	Walcott	42.117	Intermediate
44	Christine	44.126	Intermediate
48	ND 46	48.182	Intermediate
50	Hickson	50.186	Minor
54	St. Benedict	54.167	Intermediate
56	Horace	56.249	Intermediate
60	Durbin	60.252	Intermediate
62	32 nd Ave. S	62.249	Intermediate
63	Jct I-29 & I-94	63.267	Major A

<u>Exit No.</u>	<u>Interchange Name</u>	<u>Reference Point</u>	<u>Interchange Classification</u>
64	13 <sup>th</sup> Ave S	64.252	Intermediate
65	US 10	65.252	Intermediate
66	12 <sup>th</sup> Ave N	66.255	Intermediate
67	19 <sup>th</sup> Ave N	67.258	Intermediate
69	North Fargo	69.374	Major B
73	Harwood	72.778	Intermediate
79	Argusville	78.542	Intermediate
86	Gardner	85.826	Intermediate
92	Grandin	92.142	Intermediate
100	Blanchard	100.391	Intermediate
111	ND 200	110.795	Intermediate
118	Buxton	117.987	Intermediate
123	Reynolds	123.001	Intermediate
130	ND 15	130.043	Major B
138	32 <sup>nd</sup> Ave	138.146	Major B
140	6 <sup>th</sup> Ave	140.195	Intermediate
141	US 2	141.196	Major B
145	North Grand Forks	144.711	Major B
152	Manvel	144.711	Intermediate
157	Johnstown	156.680	Minor

<u>Exit No.</u>	<u>Interchange Name</u>	<u>Reference Point</u>	<u>Interchange Classification</u>
161	ND 54	160.927	Intermediate
164	Lake Ardoch	163.699	Minor
168	Minto	167.722	Intermediate
172	Pulaski	171.723	Intermediate
176	ND 17	175.792	Intermediate
180	Cashell	179.876	Minor
184	Herrick	184.038	Intermediate
187	ND 66	186.881	Intermediate
191	Pittsburg	190.955	Minor
193	Lincoln	192.960	Minor
196	Bowesmont	196.014	Intermediate
200	Carlisle	200.243	Minor
203	Jolliette	203.413	Intermediate
208	Bathgate/ Macarther	208.473	Intermediate
212	Nече	212.717	Minor
215	Pembina	215.237	Intermediate

## Sign Support Design

### Standard Pipe, W Shape Supports, and Perforated Tube Material

The sign supports for ground mounted signs are designed as cantilever beams with uniform loads on the signs. Single post supported signs include a torsional load applied at 0.15 times the sign width offset from the center of the sign support.

Programs are written to calculate the support length and sizes for a particular sign. It also determines the maximum support length for the support selected. Standard pipe posts are used for single post signs and Gore Signs. Two or more post signs are designed using Standard Pipe and W-Shape.

The Signs Calculator is a Microsoft 2000 database and can be found on North Dakota Department of Transportation web site – Click on Manuals – Sign Calculator and follow instructions.

The program will start with one post and continue until a support will fit the design requirements.

If you start with perforated tube and the support configuration does not fit the design, it will indicate the design load exceeds the allowable design requirements and you will have to use the Round Pipe or W-Shape posts.

### Design Requirements:

Formula:  $L_{max} = (CRS \times S \times N) / W_p$

$L_{max}$  = Maximum Lever Arm

S = Section Modulus of the support = Cubic inches

N = Number of supports

CRS is  $\leq 1.0$  Where  $CRS = f_a / F_a + F_b / C A F_b + (f_v / F_v)^2 = PSI$

CA = Coefficient for Amplification

$f_a$  = Calculated axial compressive stress = PSI

$f_b$  = Calculated bending stress = PSI

$f_v$  = Calculated torsional stress = PSI

$F_y$  = Specified minimum yield stress = PSI

$F_b$  = Allowable unit bending stress = PSI

$F_v$  = Allowable unit shear stress = PSI

$W_p = 0.00256(1.3V)^2 C_d C_h A$

$W_p$  = Wind load on signs = lbs.

V = Wind velocity: 85 MPH

$C_d$  = Length to Width Ratio (L/W)

If L/W < 1, then  $C_d = 1.12$

If L/W < 2, then  $C_d = 1.19$

If L/W < 5, then  $C_d = 1.2$

If L/W < 10, then  $C_d = 1.23$

Ch=Height Coefficient  
 Ch= 0.8 where the lever arm is  $\leq 180$  in.  
 Ch= 1.0 where the lever arm is  $> 180$  in.  
 A= Area of the sign = Sq. ft.

### Sectional Properties for Round Pipe, W-Shape, and Perforated Tube

Property	Standard	W Shape Pipe	Perforated Tube
Moment of Inertia (I)	$3.14 R^3 t$	**	$5.33 R^3 t$
Section Modulus (S)	$3.14 R^2 t$	**	$5.33 R^2 t$
Area of Section (A)	$6.28 Rt$	**	$8.00 Rt$
Shape Factor (Kp)	1.27	**	1.12
Radius of Gyration (R)	(1)	**	$0.816 R$
Thickness of Section (t)			

(1) R is measured to the mid thickness of the wall  
 \*\* See Steel Construction Manual

### Expressions of Maximum Stress

Stress	Standard Pipe	W Shape	Perforated Tube
Maximum Bending Stress ( fb)	$fx^2 + fy^2$	$fx^2 + fy^2$	$fx^2 + fy^2$
Maximum Shear Stress due to Transverse Loads ( vb)	$2.0 Vs/A$	$1.5Vs/A$	$2.25 Vs/A$
Maximum Shear Stress due to Torsion ( vt)	$Mz/6.28R^2t$	$MzK/8.0bf^2$	$Mzk/8.0R^2t$

Where  $K=( t^3 \times L)/3$   
 $Q = Vy$   
 t = Thickness  
 L = Length of section

### Standard Pipe

$Fy = 36,000$   
 $Fy/E (r/t) \leq 0.063$   
 $Fy/E (r/t)^{3/2} \leq 0.44$   
 $Fb = 0.66Fy$     $Fv = 0.33 Fy$



No.	Nominal Dia. – in.	R in.	t in.	Wt/Ft lbs.	S in. <sup>3</sup>	A in. <sup>2</sup>	R/T	Fy/E(R/t)
1	3.5	1.887	0.266	9.11	2.394	2.680	8.349	0.010
2	4	2.132	0.237	10.79	3.215	3.174	8.996	0.011
3	5	2.653	0.258	14.62	5.449	4.300	10.283	0.013
4	6	3.173	0.280	18.97	8.495	5.581	11.331	0.014
5	8	4.174	0.277	24.70	14.69	7.265	15.069	0.019
6	10	5.236	0.279	31.20	23.42	9.178	18.875	0.023
7	12	6.210	0.330	43.77	38.98	12.88	18.818	0.023

**W Shape**

$$F_y = \underline{36,000}$$

$$F_b = 0.60 F_y \quad F_v = 0.33 F_y$$

Compact Section

$$W/t < 2050 / F_y^{1/2} = 9.1679$$

$$D/t < 20200 / F_y^{1/2} = 90.33$$

$$D/t > 8120 / F_y^{1/2} = 36.3137$$

No.	Nominal Size	Area in. <sup>2</sup>	Web D in.	t in.	Flange Section		W/t	D/t	Modulus( x-x) in. <sup>3</sup>
					W in.	t in.			
1	W4x133.83	4.16	0.280	4.060	0.345	5.46	11.8	14.9	
2	W5x164.68	5.01	0.240	5.000	0.360	8.51	13.9	20.9	
3	W6x205.87	6.20	0.260	6.020	0.365	13.4	16.5	23.8	
4	W8x247.08	7.93	0.245	6.495	0.400	20.9	16.2	32.4	
5	W8x288.25	8.06	0.285	6.535	0.465	24.3	14.0	28.2	
6	W8x319.13	8.00	0.285	7.995	0.435	27.5	18.4	28.1	
7	W10x39	11.5	9.92	0.315	7.985	0.530	42.1	15.1	31.5

**Perforated Tubes**

$F_y = 55,000$

$F_b = 0.60 F_y$     $F_v = 0.33 F_y$

No.	size in.	t in.	wt./ft. lbs.	Section Modulus in. <sup>3</sup>	Area in. <sup>2</sup>	Radius in.	n=	t/R	Kt	Rt
1	2	0.105	2.416	0.372	0.590	0.9475	1.49	0.1108	1.187	1.571
2	2.25	0.105	2.773	0.499	0.695	1.0725	1.49	0.0979	1.200	1.242
3	2.50	0.105	3.141	0.643	0.803	1.1975	1.49	0.0877	1.225	0.980
4	2.5	0.135	4.006	0.783	1.010	1.1825	1.49	0.1142	1.180	0.781
5	2 & 2.25	0.210	5.189	0.871	1.285	1.0200	1.49	0.2059	1.100	0.629
6	2.25 & 2.50	0.210	5.914	1.142	1.498	1.1450	1.49	0.1834	1.115	0.506
7	2.1875 & 2.5	0.270	7.438	1.373	1.851	1.1150	1.49	0.2422	1.080	0.402

**Foundation Design**

Maximum Overturn Moment =  $W_p \times L_{max}$

where:

$W_p = (CRS \times S) / L_{max}$

$W_p$  = Wind Load on the Sign=lbs.

CRS=Combined Stress Ratio

S= Section Modulus= in.<sup>3</sup>

$L_{max}$ = Maximum Lever Arm

Formula:       $P/S1 = bD^2 / ( 2.37 D + 2.64 H )$

- Where:
- P = Load on the sign
  - D = Embedment Depth of Foundation
  - b = Width of Foundation
  - S1 = Soil Pressure
  - H = Load Lever Arm

**Standard Widths of Foundations**

<b>Standard Pipe Post Dia. in.</b>	<b>Foundation Dia. ft.</b>	<b>W Shape Post Size</b>	<b>Foundation Dia. ft.</b>
3.5 & 4	b = 1'-4"	W4x13	b = 1'-9"
5 & 6	b = 1'-9"	W5x16	b = 1'-9"
8	b = 2'-0"	W6x20	b = 2'-0"
10	b = 2'-4"	W8x24	b = 2'-4"
12	b = 2'-6"	W8x28	b = 2'-4"
		W8x31	b = 2'-6"
		W10x39	b = 2'-6"

**III-10.01 Pavement Marking**

Markings on highways have important functions to provide guidance and information for road users. Major marking types include pavement, and curb markings, object markings, delineators, colored pavements, barricades, channelizing devices, and islands. They are used to supplement signing and other devices and they are used alone where other devices can't achieve the desired result. Basically, it consists of Long Term and Short Term Markings consisting of Striping and Messages.

**III-10.01.1 Pavement Marking Material**

Generally, Paint, Epoxies and Preformed Plastic are used for Long Term markings. The Plastic may also be inlaid in Asphalt Pavements or Grooved in PCC Pavements. The type of Pavement Marking to be used may be found in the table, **Pavement Marking Material Selection**, in Appendix III-10 A.

**III-10.01.2 Long Term Pavement Marking**

Generally, this type marking is covered by Part III of the MANUAL OF UNIFORM TRAFFIC CONTROL DEVICES (MUTCD). These requirements have been standardized in the following Standards:

1.	Interstate Mainline and Ramps	D-762-2
2.	Rural and Urban two and four lane roads and Interstate.	D-762-4
3.	Flared Intersections	D-762-3
4.	Narrow Bridges	D-754-84
5.	Railroad	D-762-1
6.	Pavement Messages	D-762-1
7.	School Message      Part VI of MUTCD and	D-762-1
8.	Left Turn Lane, Stop Bar, and Crosswalk Lines	Typical Detail
9.	Bicycle Lane Markings	Typical Details

These Standard can be found on [www.state.nd.us](http://www.state.nd.us) under design division standards.

Note-The Typicals are located in Appendix III-10 B and Appendix IIIB10 C. The Standards are in the Book of Standards.

### III-10.01.3 Short-Term Pavement Marking

Generally, this type pavement Marking is placed in construction zones for up to two (2) weeks.

All Short-Term Pavement Markings, including no-passing zones, should conform to Chapter 3B, 7C, and 9C, Section 8b.16 of the MUTCD and as follows

- All short-term broken line pavement marking (lane line and center line ) of 2-lane 2-way roadways should use the same cycle length as Long Term markings and be 10 foot in length. The cycle length is 40 feet.
- For those short-term situations of 3 calendar days, or less, for 2 or 3 lane roadways, no-passing zones may be identified by using signs rather than pavement markings.
- For Seal and Paving projects with  $ADT \leq 750$  short-term pavement marking may be used. In lieu of markings, “No Center Stripe” and “Do Not Pass” signs may be used as shown in D-704-20 type H.

#### III-10.01.03.1 Paint or Tape Pavement Marking

Short-Term pavement marking paint and beads or pavement marking tape should be applied 4 inches wide and 10 feet in length with an unmarked gap of 30 feet for lane lines and center lines of two lane two way roadways. When required, no-passing zones should be marked with a 4 inch wide line long enough to cover the no-passing zone with paint or tape.

Short-term pavement marking should be applied to the roadway for the full length of the surfacing or milled surface before sunset of the same day the work is accomplished.

#### III-10.01.03.2 Raised Pavement Markers

Raised Pavement Markers (RPMs) may be used without the use of any other pavement markings. When RPMs are used to simulate lines, it is important they are visible day and night. The following guidelines should be applied:

- Lane and Center Lines of two lane, two way roadways- Four (4) RPMs should be used at 3.33 foot centers with a 30 foot gap.
- Solid Lines- The RPMs should be placed on five (5) foot centers to simulate solid lines.
- Double Solid Lines - The RPMs should be placed on five (5) foot centers.

There are three situations where RPMs do not provide adequate simulation of solid lines. When these occur, especially on low speed urban highways, it is necessary to provide these lines with paint or tape. When the existing surface is to be removed, the markings should be painted.

Where the existing surface is to remain in place or is the finished surface, the markings should be removable tape. The three situations are as follows:

- Areas where the RPMs, even at 5 foot centers, become visually separated. This occurs on low speed urban roadways with sharp curves and short transitions. This also occurs where there are steep grades and dips.
- Areas of high ambient lighting which may diminish the retro reflective capabilities of the RPMs.
- Areas where the traffic control will be in place over the winter.

### III- 10.01.3.3 Raised Pavement Marker Types

- Type 1- These are acceptable for use on all roadways for short or long term projects. They may be used to simulate solid or broken lines and should be installed and spaced as shown on Standard Drawing DB762B6.
- Type 2- These markers are acceptable for use where needed for less than 15 calendar days and where the traffic is less than 3,000 ADT They may be used to simulate solid or broken lines as shown on DB762B6.
- Type 3- These are acceptable on chip and sand seal operations. They are designed to be placed prior to beginning seal operations. They have a protective cover that is removed after the application of the seal coat. Generally, these are used to spot the center line by installing at 200 foot centers and marking the beginning and end of the no-passing zones.

### III - 10.01.3.4 Seal Coat Projects

Pavement marking should consist of Pavement Marking Paint and Beads. Prior to beginning operations, RPMs should be installed every 200 feet along the center line and at the beginning and end of no-passing zones.

The pavement marking should be in place prior to sunset each day for the full length of roadway that received the seal coat that day as follows:

- Two-Lane Two-Way - The Yellow Broken Center Line should be 4 inches wide and 4 feet long followed by a 36 foot gap.
- Multilane - The White Lane Lines should be 4 inches wide and 4 feet long followed by a 36 foot gap.
- For both types of roadways, the Solid Line Barrier Stripe and No-Passing zones marking should be 4 inches wide for the length to cover the entire barrier line and no-passing zone.

**III-10.01.3.5 Edge Lines**

Pavement Markings are not required unless there is some circumstance that would suggest they be used. If used they are limited to a duration of 60 days.

**III-10.01.3.6 School Zone**

Pavement markings are not required if regulations and warnings are conveyed by other devices such as traffic signs, beacons, or signals. If it is determined that school zones can't be adequately protected with these other devices, pavement marking should be installed. Pavement markings are limited to a duration of 60 calendar days except this limit should be no more than 15 calendar days when the Permanent Markings are not installed by August 15.

**III-10.01.3.7 Railroad Crossing**

Pavement marking is not required, if warning signs and cross bucks are present, unless there are special circumstances. The pavement markings are limited to 60 calendar days.

**III-10.01.3.8 Stop Lines**

Pavement markings are not required except in locations where it is determined to be important to indicate the point, behind which, vehicles should stop in compliance with Stop Signs or Traffic Signals. These markings are limited to 60 calendar days except this limit will be 15 calendar days if the permanent markings are not installed by September 15.

Markings for Stop Lines for actuated signals may be required because if the stop location is not indicated, there may be erratic signal operation or traffic movements.

**III-10.01.3.9 Crosswalks**

Crosswalks should be marked at designated non-intersection crossings if such crossings are legally permitted. Markings should be provided at intersections where it is determined that there is substantial conflict between vehicle and pedestrian movements or where there is a need to guide pedestrians in a proper path. Markings may be omitted at locations where the above criteria do not suggest usage. These markings are limited to 60 calendar days.

**III-10.01.3.10 Word and Symbol Markings and Channelization Lines**

Pavement Markings for these features are not required if regulations, warnings, or guidance are conveyed by other devices. If it is determined that these features are needed they should be installed. The Markings for these features are limited to 60 calendar days.

### III-10.01.3.11 No-Passing Zone Markings on State Highway System

No-passing zone shall be marked by either the one direction no-passing zone pavement markings or two-direction no-passing zone pavement markings described and shown in figure III-10.3A and 3B.

When centerline markings are used, no-passing zone markings shall be used on two-way roadways at lane reduction transitions (see figure III-10.3C) and on approaches to obstructions that must be passed on the right (see figure III-10.3D).

Where centerline markings are used, no-passing zone markings shall be used on approaches to highway-rail grade crossings in conformance with Standard Drawing 762-1.

On two-way, two- or three lane roadways, where centerline markings are installed, no-passing zones shall be established at vertical and horizontal curves and other locations where an engineering study indicates that passing must be prohibited because of sight distance or other special conditions.

On three-lane roadways where direction of travel in the center lane transitions from one direction to the other, a no-passing buffer zone shall be provided in the center lane as shown in figure III- 10.3E. A lane transition shall be provided at each end of the buffer zone.

The buffer zone shall be a median island that is at least 50 feet in length.

The minimum lane transition taper length shall be 100 feet in urban areas and 200 feet in rural areas.

On roadways with centerline markings, no-passing zones markings shall be used for horizontal or vertical curves where passing sight distance is less than the minimum necessary for reasonably safe passing at the 85<sup>th</sup>-percentile or the posed or statutory speed limit as shown in table III-10.3F. The passing sight distance on a vertical curve is the distance at which and object 3.5 feet above the pavement surface can be seen from a point 3.5 feet above the pavement (see figure III-10.3G). Similarly, the passing sight distance on a horizontal curve is the distance measured along the centerline (or right-hand lane of a three-lane roadway) between two points 3.5 feet above the above the pavement on a tangent to the embankment or other obstruction that cuts off the view on inside of the curve (see figure III-10.3G).



Where a segment of highway, with less than 400 feet of adequate sight distance, exists between two no-passing zones, the striping should be continuous from one on-passing zone to the other.

**Table III-10.3E**

<b>85<sup>th</sup>- Percentile or Posted or Statutory Speed limit (mph)</b>	<b>Minimum Passing Sight Distance  (feet)</b>
25	450
30	500
35	55
40	600
45	700
50	800
55	900
60	1,000
65	1,100
70	1,200

Figure III-10.3A  
Two-Lane, Two  
Way Marking  
Application

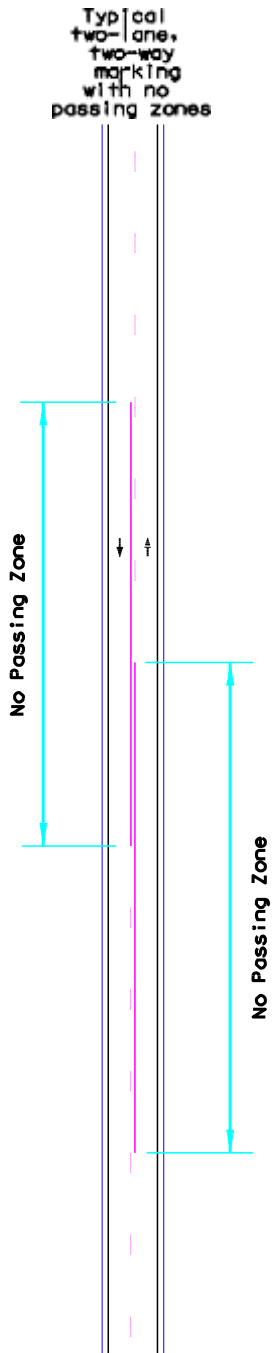
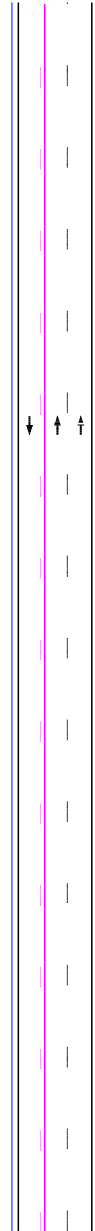
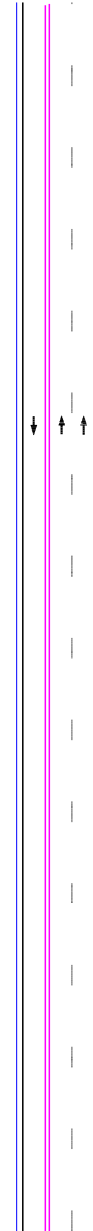


Figure III-10.3B  
Examples of Three-Lane,  
Two-Way Marking  
Application

Typical  
three-lane,  
two-way  
marking  
with passing  
permitted in  
single-lane  
direction

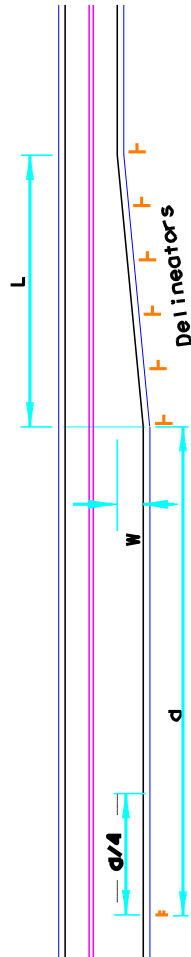


Typical  
three-lane,  
two-way  
marking  
with passing  
permitted in  
single-lane  
direction

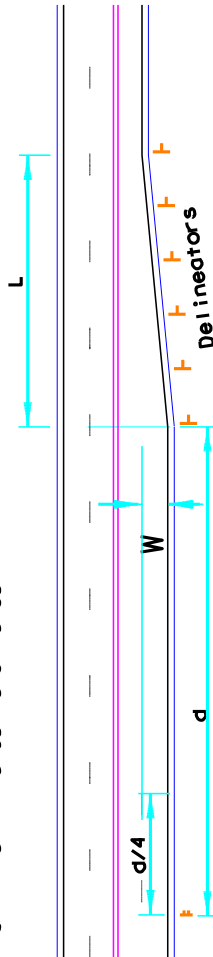


**Figure III-10.3C Examples of Lane Reduction Markings**

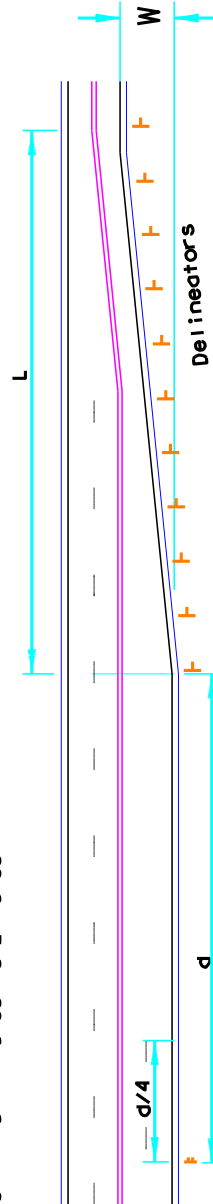
a - from 3 lanes to 2 lanes



b - from 4 lanes to 3 lanes

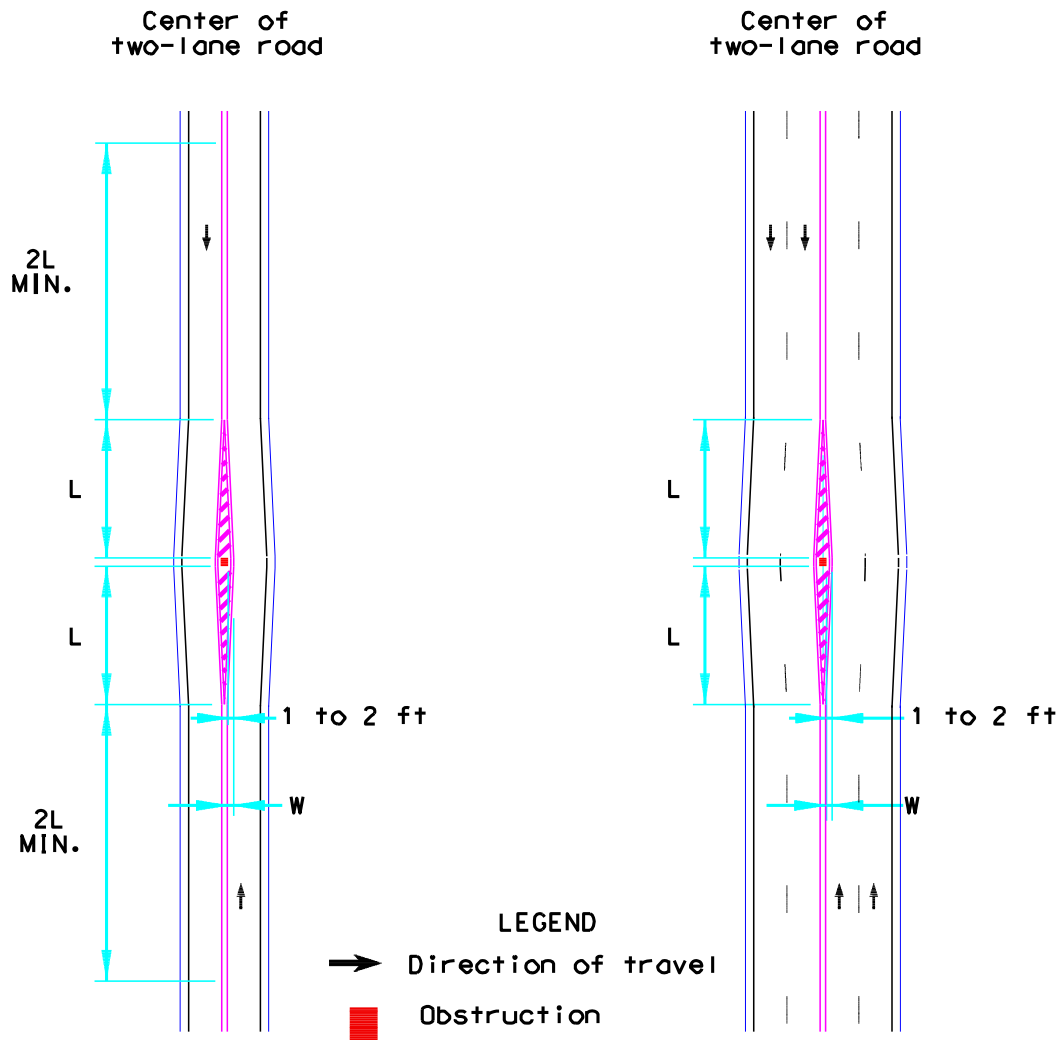


c - from 4 lanes to 2 lanes



For speeds 45 mph or more  
 $L=0.62 WS$  ( $L=WS$ )  
 For speeds less than 45 mph  
 $L=WS^2/155$  ( $L=WS^2/60$ )  
 $S$ =Posted, 85th-percentile, or statutory speed in mph  
 $W$ =Offset distance in ft  
 $L$  = Length in Feet  
 $d$  = Advance warning distance (see Section III-9.041)

Figure III-10.3D Example of Markings for Obstructions in the Roadway  
(Sheet 1 of 2)



For speeds 45 mph or more  $L=0.62 WS$  ( $L=WS$ )

For speeds less than 45 mph  $L=WS^2/155$  ( $L=WS^2/60$ )

S=Posted, 85th-percentile, or statutory speed in mph

W=Offset distance in ft

Minimum length of: L= 100 ft in urban areas

L= 200 ft in rural areas

Length "L" should be extended as required by sight distance conditions.

Figure III- 10.3D Examples of Markings for Obstruction in the Roadway (Sheet 2 of 2 Legend

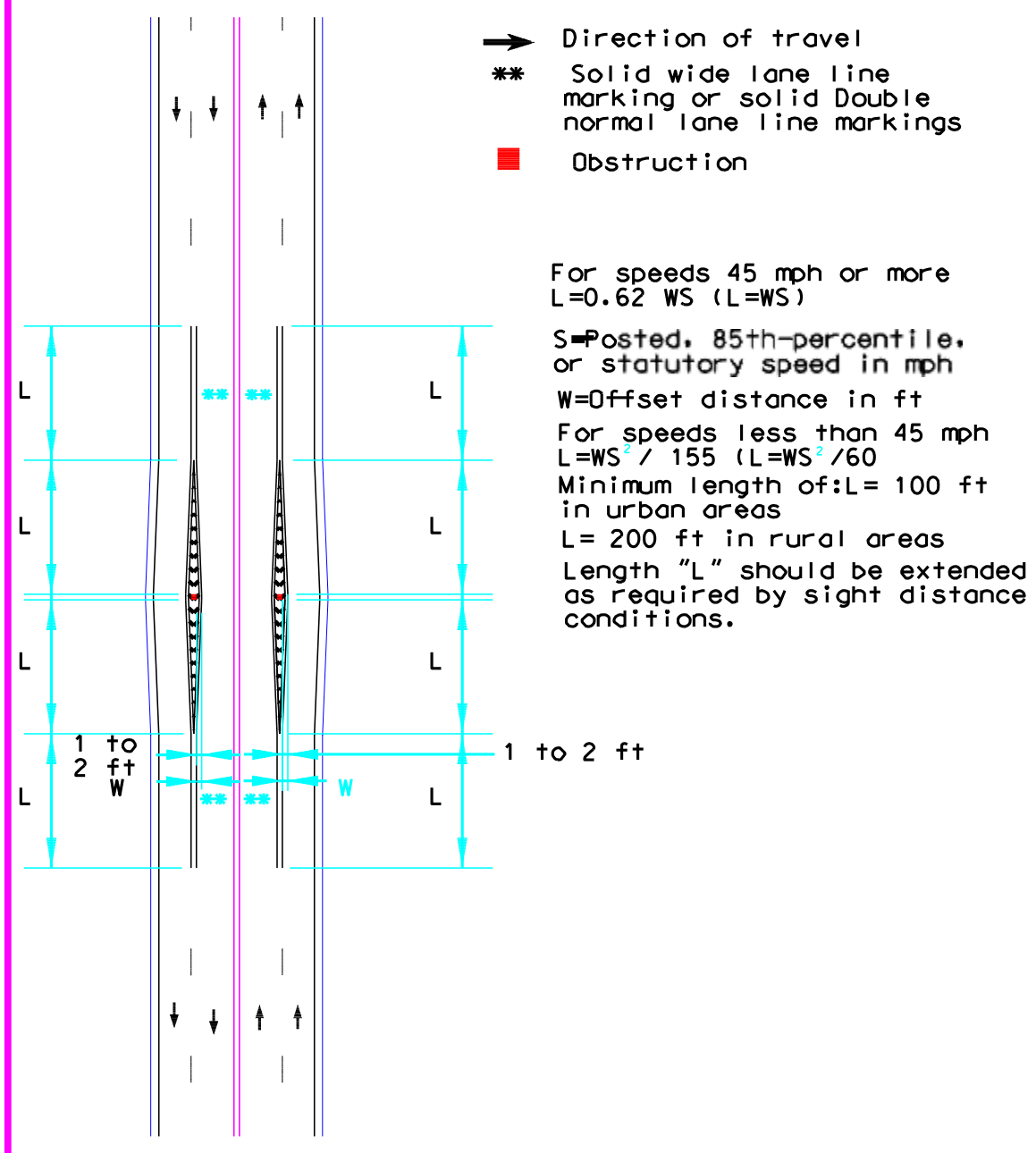


Figure III-10.3E

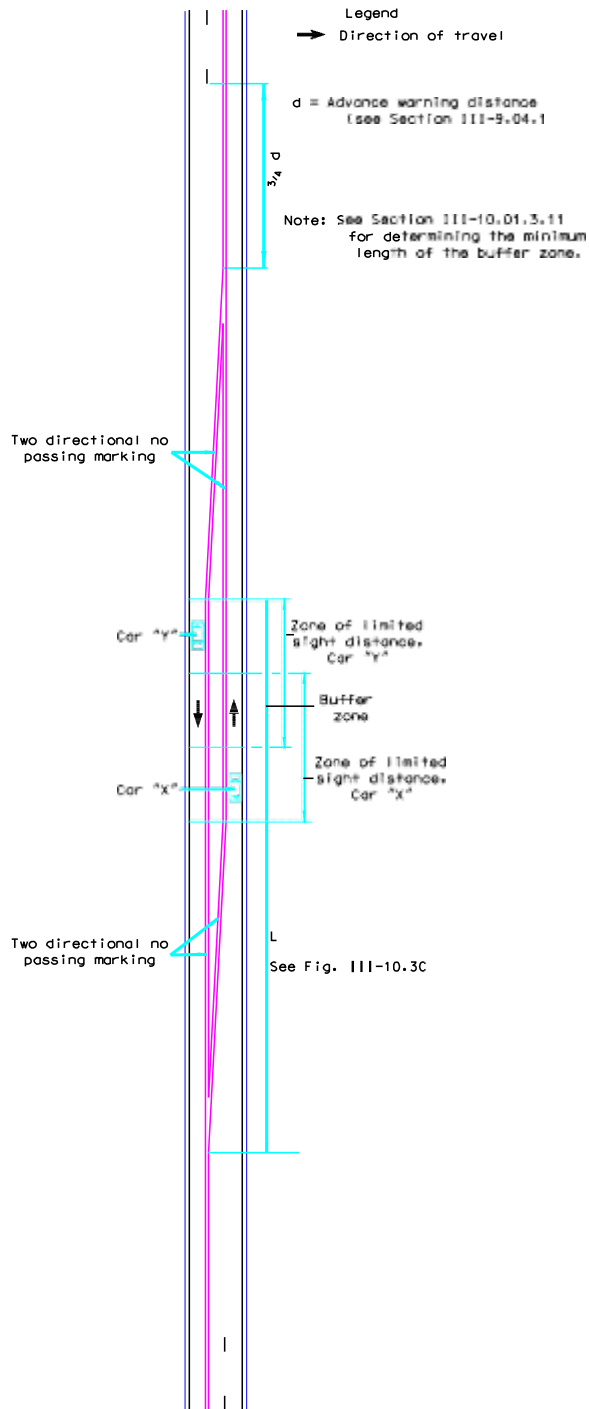
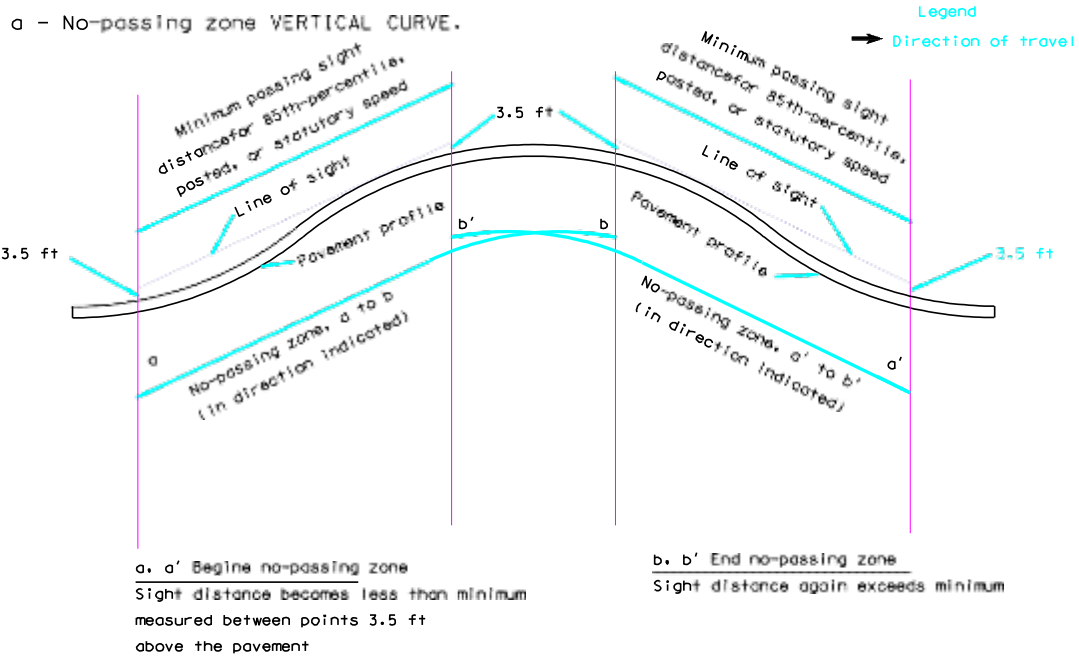


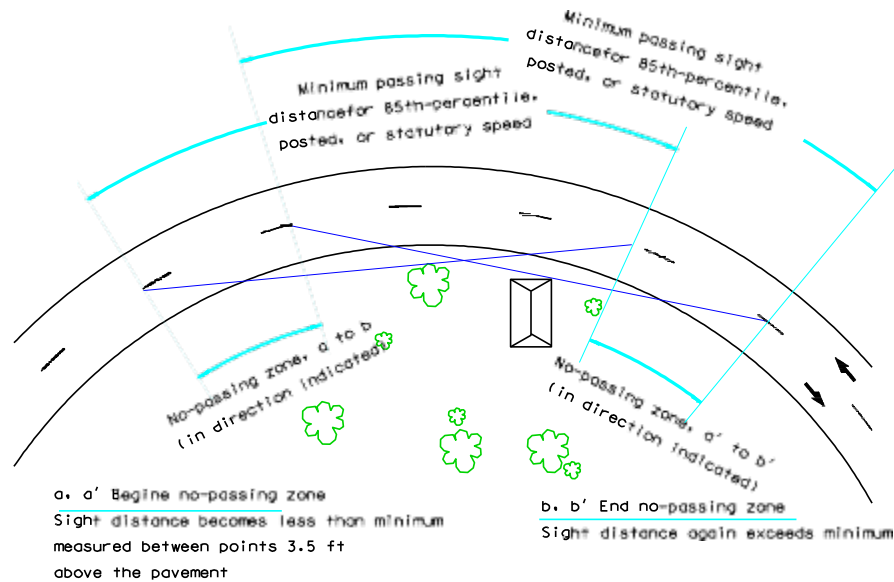
Figure III-10.3F Method of locating and determining the Limits of No-Passing Zones at Curves



**PROFILE VIEW**

Note: No-passing zones in opposite direction may or may not overlap, dependent on alignment

b - No-passing zone at HORIZONTAL CURVE.



**PLAN VIEW**

Note: No-passing zones in opposite direction may or may not overlap, dependent on alignment

**III-10.02 Delineators**

Delineators should be installed along the Interstate, divided highway expressways, interchanges, rest areas, median crossovers, and consideration should also be given to approaches where local roads or county roads intersect a major roadway.

The request to delineate an approach should come from law enforcement and/or Local Government. Residential drives and field drives will not be considered for delineation.

The following conditions should be considered when determining if an approach should be delineated. If any one of the conditions are true, it may warrant delineator installation.

- 1) Crash history with a countermeasure being the installation of delineators.
- 2) Decision sight distance for avoidance maneuver.
  - A. 65 mph, 1050 feet
  - B. 60 mph, 990 feet
  - C. 55 mph, 865 feet
  - D. 50 mph, 750 feet
  - E. 45 mph, 675 feet
  - F. 40 mph, 600 feet

Where the decision sign distance is less than the distances shown, the approach in question should be moved or the addition of a warning sign shall be installed for the intersection along the state highway. Suggested signs to be used may include W2-1 or W2-2, dependent on the type of intersection.

- 3) Engineering judgement.



## Introduction

Pavement markings have different life expectancies and costs. Low cost pavement markings, such as paint, do not last, and must be replaced frequently. Pavement marking locations and traffic volumes are also determining factors that contribute to the life expectancy of the pavement marking.

The goal is to provide an appropriate pavement marking for all highways, 365 days per year.

## Purpose and Definition

The purpose is to establish a statewide approach for pavement marking installation and material life.

An acceptable pavement marking is one that conforms in all respects to the principles and standards set forth in the Manual on Uniform Traffic Control Devices (MUTCD). During snow and ice operations pavement markings should provide delineation after bare pavement is attained.

## Guidelines

Every effort shall be made to select pavement marking materials that are compatible with the anticipated life of the surfacing section, before the next surface treatment is performed, or are compatible with the expected life of the existing pavement marking materials on adjacent roadway sections. Pavement markings on projects shall be extended, as necessary, so transitions in material types are logical. For example, a short segment with short life material should not separate two road segments with longer life markings. Pavement marking portions of projects should also be extended so termination points of long life materials segments are logical. Examples include exit and entrance ramps within projects and extension of long life materials to major intersections or other logical termini. **The termini for longer life markings should be determined on a project prior to Project PS&E, between the District, Designer, and Design Traffic Safety Engineer.**

All pavement marking materials shall be installed according to the manufacturer's specifications. This may include removal of existing pavement markings and other surface treatments as recommended by the manufacturer.

Four tables are provided for guidance of pavement marking material selection based on rural or urban location, type of roadway, and anticipated surface life. If the use of a longer lasting pavement marking material, than what is shown, can be justified, then it would be acceptable to install this material.

The type of pavement markings should be determined as follows.

The designer should determine if the location is rural or urban, type of roadway and what the anticipated life of the surface pavement will be before the next surface treatment is performed.

The pavement marking material selected should have an anticipated life expectancy that is the same or less than the anticipated life expectancy before the next surface treatment is performed. **The Traffic Safety Section would be able to assist in this selection.**

Example: The expected life of the new pavement surface on a rural two lane two way highway is 20 years, but the pavement is to be seal coated in 1 to 4 years, therefore the anticipated life of new pavement is 1 to 4 years before the next surface treatment. This section of highway has a present ADT of <1500. Therefore, the pavement marking centerline should be paint and the edgelines should be paint.

Example: The expected life of a new pavement surface on a rural two lane two way highway is 20 years and the pavement will be seal coated in 2 to 4 years and the ADT is 1500 to 4000, therefore the pavement marking centerline should be epoxy and the edgelines should be paint.

Example: An asphalt surface having an expected life of 20 years on a rural two lane two way highway and the ADT is 1500 to 4000 is to be seal coated. It is determined that the seal coat has an anticipated life of 8 years. The centerline should be grooved epoxy and the edge line should be epoxy. The centerline could be placed and then have tape with masking placed just before the seal coat is placed. The masking shall be removed when the seal is completed. Edgelines should be marked using epoxy after the seal is placed.

Example: The expected life of a new concrete surface on a rural two lane roadway is 40 years and the pavement will be rehabilitated in 15 years, and the present ADT is over 4000, therefore the pavement markings that will meet these requirements is grooved epoxy for both centerline and the edgelines.

#### Pavement Marking Life Expectancy

Materials	ADT		
	<1,500	1,500 - 4000	>4000
Paint	1 yr.	1 yr.	<1 yr.
Epoxy	> 5 yr.	4-5 yr.	3-4 yr.
Grooved Epoxy	> 5 yr.	> 5 yr.	> 5 yr.
Tape	> 5 yr.	> 5 yr.	> 5 yr.
Grooved Tape	> 8 yr.	> 8 yr.	> 8 yr.

**Rural  
Pavement Marking Goals  
Two Lane Two Way Highways**

Anticipated Surface Life <sup>1</sup> (years)		ADT					
		< 1,500		1,500 - 4,000		> 4,000	
		Edgeline	Centerline	Edgeline	Centerline	Edgeline	Centerline
0 - 2		Paint	Paint	Paint	Paint	Paint	Paint
2 - 4		Paint	Paint	Paint	Epoxy	Epoxy	Epoxy
4 - 6	Asphalt	Paint	Paint	Epoxy	Epoxy	Epoxy	Epoxy
	Concrete	Paint	Paint	Epoxy	Epoxy	Epoxy	Epoxy
6+	Asphalt	Paint	Paint	Epoxy	Epoxy	Grooved Epoxy (A)	Epoxy
	Concrete	Paint	Paint	Epoxy	Epoxy	Grooved Epoxy (A)	Epoxy

(A) If grooved epoxy and rumble strips coincide, grooved epoxy should not be used and epoxy should be applied. Shoulder widths of less than 4', edgeline should have epoxy.

<sup>1</sup> Anticipated life of the surface is based on the design life of the new pavement or the anticipated time before the next surface treatment.

**Rural  
Pavement Marking Goals  
Multilane Divided and Undivided Highways**

		< 1,500		1,500 - 4,000		> 4,000	
		Edgeline	Centerline	Edgeline	Centerline	Edgeline	Centerline
0 - 2		Paint	Paint	Paint	Paint	Paint	Paint
2 - 4		Paint	Paint	Paint	Epoxy	Epoxy	Epoxy
4 - 6	Asphalt	Epoxy	Epoxy	Epoxy	Grooved Epoxy (A)	Epoxy	Grooved Epoxy (A)
	Concrete	Epoxy	Epoxy	Epoxy	Grooved Epoxy (A)	Epoxy	Grooved Epoxy (A)
6+	Asphalt	Epoxy	Epoxy	Epoxy	Grooved Epoxy (A)	Grooved Epoxy (A)	Grooved Epoxy (A)
	Concrete	Epoxy	Epoxy	Epoxy	Grooved Epoxy (A)	Grooved Epoxy (A)	Grooved Epoxy (A)

(A) If grooved epoxy and rumble strips coincide, grooved epoxy should not be used and epoxy should be applied. Shoulder widths of less than 4', edgeline should have epoxy.

<sup>1</sup> Anticipated life of the surface is based on the design life of the new pavement or the anticipated time before the next surface treatment.

**Urban  
Pavement Marking Goals  
Two Lane Two Way Highways**

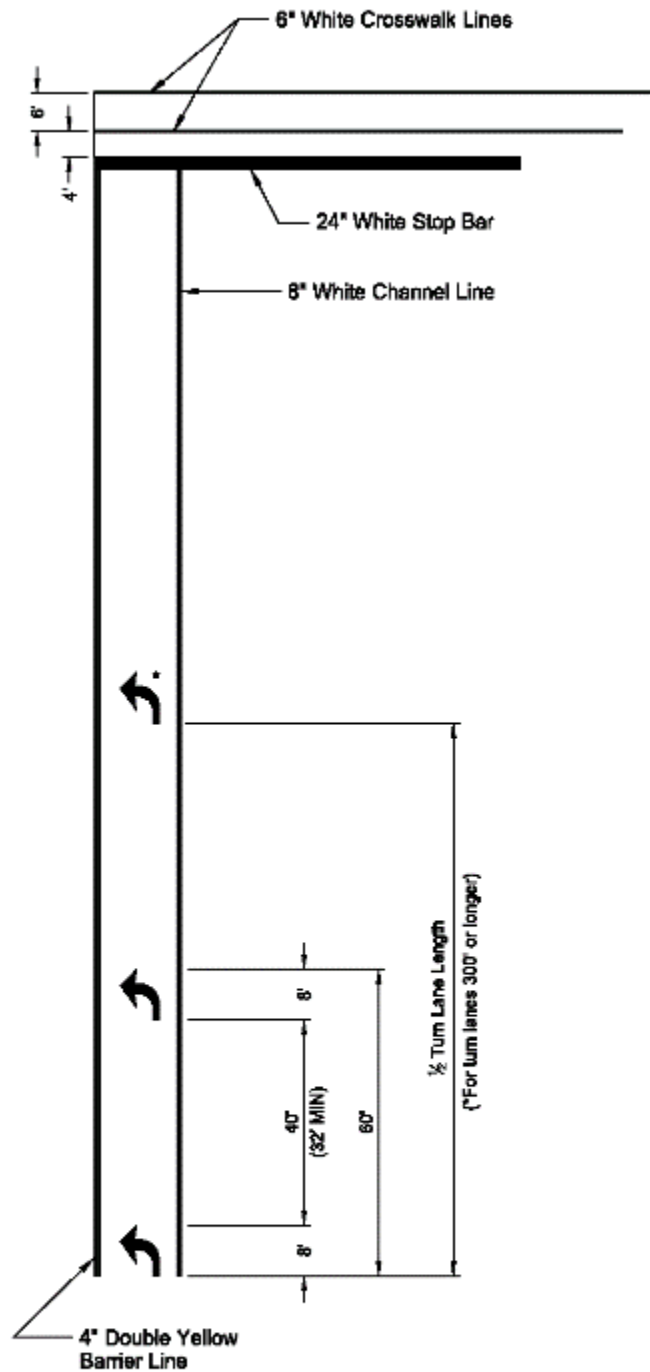
Anticipated Surface Life <sup>1</sup> (years)		ADT					
		< 1,500		1,500 - 4,000		> 4,000	
		Edgeline	Centerline	Edgeline	Centerline	Edgeline	Centerline
0 - 2		Paint	Paint	Paint	Paint	Paint	Paint
2 - 4		Paint	Paint	Paint	Epoxy	Epoxy	Epoxy
4 - 6	Asphalt	Paint	Paint	Epoxy	Grooved Epoxy	Grooved Epoxy	Grooved Epoxy
	Concrete	Paint	Paint	Epoxy	Grooved Epoxy	Grooved Epoxy	Grooved Epoxy
6+	Asphalt	Paint	Paint	Epoxy	Grooved Tape	Grooved Tape	Grooved Tape
	Concrete	Paint	Paint	Epoxy	Grooved Tape	Grooved Tape	Grooved Tape

<sup>1</sup> Anticipated life of the surface is based on the design life of the new pavement or the anticipated time before the next surface treatment.

**Urban  
Pavement Marking Goals  
Multilane Divided and Undivided Highways**

Anticipated Surface Life <sup>1</sup> (years)		ADT					
		< 1,500		1,500 - 4,000		> 4,000	
		Edgeline	Centerline	Edgeline	Centerline	Edgeline	Centerline
0 - 2		Paint	Paint	Paint	Paint	Paint	Paint
2 - 4		Paint	Paint	Paint	Epoxy	Epoxy	Epoxy
4 - 6	Asphalt	Epoxy	Epoxy	Epoxy	Grooved Epoxy	Grooved Epoxy	Grooved Epoxy
	Concrete	Epoxy	Epoxy	Epoxy	Grooved Epoxy	Grooved Epoxy	Grooved Epoxy
6+	Asphalt	Epoxy	Epoxy	Epoxy	Grooved Tape	Grooved Tape	Grooved Tape
	Concrete	Epoxy	Epoxy	Epoxy	Grooved Tape	Grooved Tape	Grooved Tape

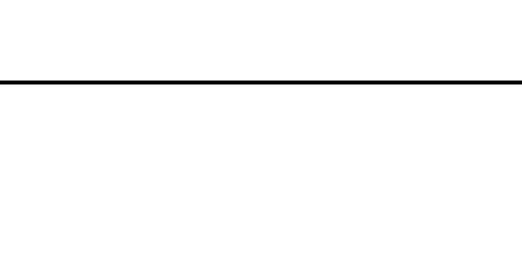
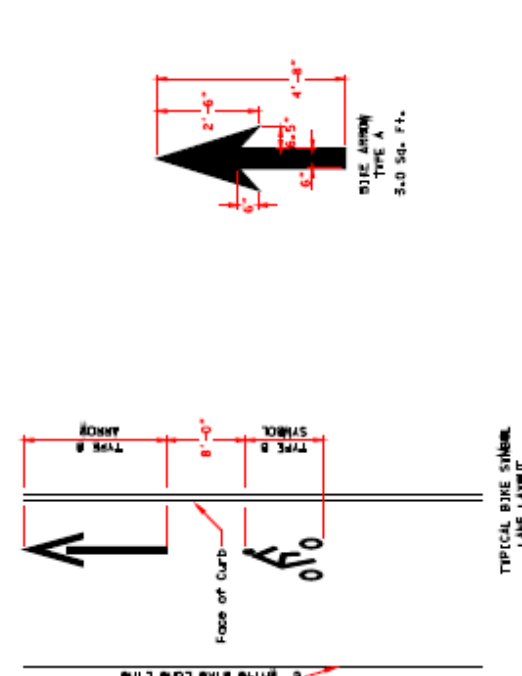
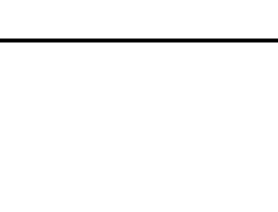
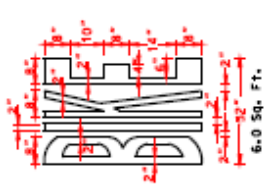
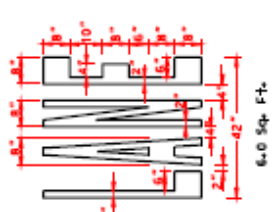
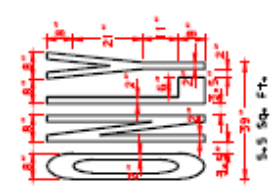
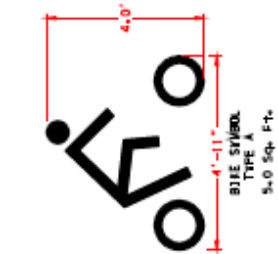
<sup>1</sup> Anticipated life of the surface is based on the design life of the new pavement or the anticipated time before the next surface treatment.



**TYPICAL PAVEMENT MARKING DETAIL**  
For Left Turn Lane, Stop Bar  
and Crosswalk Lines

PAVEMENT MARKING  
BICYCLE LANE DETAILS

Note: Message and Symbols shall be white.



**III-11.01 Warrants for Highway Lighting**

Warrants for highway lighting should follow the NDDOT Lighting Warrant Policy found on the Manuals and Publications webpage at:

<https://www.dot.nd.gov/manuals/manuals-publications.htm>.

**III-11.02 Plans and Specifications**

The plans and specifications for all lighting facilities to be installed on or adjacent to state highways, including service roads, constructed under an agreement between the state and a local government agency, are subject to approval by NDDOT.

**III-11.02.01 Design Requirements**

All new lighting installations shall utilize LED lighting.

Due to the use of dark aggregates in hot bituminous pavement and staining of concrete roadways, the value for road surface classification as shown in AASHTO's Roadway Lighting Design Guide, 2005, should be R3 for both types of roadway surfaces.

The total Light Loss Factor (LLF) is based on luminaire dirt depreciation, lamp lumen depreciation and equipment factor. For conventional or decorative lighting where location is close to the roadway, the LLF value should be 0.69. For high mast lighting, the LLF value should be 0.81.

The specific lighting and traffic signal foundation size shall be shown in the plans for each foundation installed with the project. Refer to the table on the following page for the specific foundation diameter and depth requirements for various lighting and traffic signals.

<b>LIGHTING &amp; TRAFFIC SIGNAL FOUNDATION TABLE</b>			
<b>(USE FOR SINGLE MAST ARMS ONLY)</b>			
<b>Description</b>	<b>Footing Depth, "D"</b>		<b>Footing Depth, "D"</b>
	<b>24" &amp; 30" Ø</b>		<b>36" &amp; 42" Ø</b>
	<b>(ft)</b>		<b>(ft)</b>
<b>Light Standard</b>			
30'-35' Mounting Height	6		5
36'-44' Mounting Height	6		5
45'-50' Mounting Height	8		7
<b>Type I, II, V, VI, VII Signal Standard</b>			
	4		3
<b>Type IV Signal Standard</b>			
0'-25' Signal Mast Arm	11,11		11,11
26'-30' Signal Mast Arm	12,12		12,12
31'-35' Signal Mast Arm	12,12		12,12
36'-39' Signal Mast Arm	13,13		13,13
40'-45' Signal Mast Arm	16,15		15,15
46'-50' Signal Mast Arm	16,16		15,15
51'-55' Signal Mast Arm	17,16		16,16
56'-60' Signal Mast Arm	18,17		17,17
<b>Combination 30' Mounting Height</b>			
0'-25' Signal Mast Arm	11,11		11,11
26'-30' Signal Mast Arm	12,12		12,12
31'-35' Signal Mast Arm	13,13		13,13
36'-39' Signal Mast Arm	14,14		14,14
40'-45' Signal Mast Arm	16,16		15,15
46'-50' Signal Mast Arm	17,16		16,16
51'-55' Signal Mast Arm	17,17		16,16
56'-60' Signal Mast Arm	18,18		17,17

<b>LIGHTING &amp; TRAFFIC SIGNAL FOUNDATION TABLE</b>			
<b>(USE FOR SINGLE MAST ARMS ONLY)</b>			
<b>Description</b>	<b>Footing Depth, "D"</b>		<b>Footing Depth, "D"</b>
	<b>24" &amp; 30" Ø</b>		<b>36" &amp; 42" Ø</b>
	<b>(ft)</b>		<b>(ft)</b>
<b>Combination 40' Mounting Height</b>			
0'-25' Signal Mast Arm	12,12		12,12
26'-30' Signal Mast Arm	13,13		13,13
31'-35' Signal Mast Arm	13,13		13,13
36'-39' Signal Mast Arm	14,14		14,14
40'-45' Signal Mast Arm	16,16		15,15
46'-50' Signal Mast Arm	17,16		16,16
51'-55' Signal Mast Arm	18,17		16,16
56'-60' Signal Mast Arm	19,18		17,17
<b>Combination 50' Mounting Height</b>			
0'-25' Signal Mast Arm	12,12		12,12
26'-30' Signal Mast Arm	13,13		13,13
31'-35' Signal Mast Arm	14,13		13,13
36'-39' Signal Mast Arm	15,14		14,14
40'-45' Signal Mast Arm	17,16		16,16
46'-50' Signal Mast Arm	17,16		16,16
51'-55' Signal Mast Arm	18,17		17,17
56'-60' Signal Mast Arm	19,18		18,17



### III-11.02.01 Breakaway Light Standards

Breakaway light standards do not apply to High Mast Lighting.

Breakaway light standards, designed to minimize damage or injury when struck by an errant vehicle, should be specified under the following conditions:

- All lighting facilities to be used on interstate highways, including crossroad lighting, unless the light standards will be located behind adequate guardrail or bridge rail.
- All light standards to be installed within the clear zone, as shown in Tables 1 and 2 of Appendix 3-14B where the speed limit exceeds 25 mph except:
  - When the light standard is located near a pedestrian facility where light standards may fall on the pedestrian facility when impacted. However, an engineering study of the roadside conditions may warrant the installation of breakaway standards.

### III-11.03 Reference Material and Computer Programs

- AASHTO's Roadway Lighting Design Guide, 2005
- National Electric Code
- American Electric Handbook
- Illuminating Engineers Society (IES) publication RP-8-00, Roadway Lighting
- Visual Professional Edition Version 2.05.0000 Program for Conventional Lighting
- Visual Professional Edition Version 2.05.0000 Program for High Mast Lighting and Sign Lighting

### III-11.04 Standard Drawings

There are design features that are used frequently and these have been embodied in the 770 Standard Drawings, which are available on the web at:

<http://www.dot.nd.gov/dotnet2/view/stddrawings.aspx>

Traffic control signals are valuable devices for the control of motor vehicle and pedestrian traffic. Because they assign the right of way to the various traffic movements, traffic signals exert a profound influence on traffic flow.

Traffic control signals, when properly located and operated, usually have one or more of the following advantages:

1. They can provide for the orderly movement of traffic.
2. Where proper physical layouts and control measures are used, they can increase the traffic handling capacity of the intersection.
3. They can reduce the frequency of certain types of crashes, especially the right-angle type.
4. Under favorable conditions, they can be coordinated to provide for continuous or nearly continuous movement of traffic, at a definite speed, along a given route.
5. They can be used to interrupt heavy traffic at intervals to permit other traffic, vehicular or pedestrian, to cross.

Even though warranted, if not properly placed, operated, or maintained, the following can result:

- Excessive delay may be caused.
- Disobedience of the signal indication is encouraged.
- The use of less adequate routes may be induced in an attempt to avoid the signal.
- Crash frequency (especially the rearBend type) can be significantly increased.

### **III-12.01 Engineering Study**

Because there are disadvantages as well as advantages in the use of traffic signals, it is important to conduct an engineering study of the traffic operations before placing a signal at a particular location. Generally, this is conducted by the Programming Division and the recommendations are contained in the Traffic Operations Report.

### **III-12.02 Warrants**

A careful analysis of traffic operations and other factors at a large number of signalized and unsignalized intersections, coupled with the judgment of experienced engineers, have provided a series of warrants that define the minimum conditions under which signal installations may be justified.

There are 9 warrants and they may be found in Part 4 Chapter C of the Manual on Uniform Traffic Control Devices (MUTCD).

**III-12.03 Design Requirements**

If the design speed is 30 mph or less, the signal standard should be placed a minimum of 2' from the curb face to the signal standard base.

If the design speed is greater than 30 mph, the signal standard should be placed outside the clear zone. If the signal standard is placed within the clear zone, it should be shielded from traffic. Feed points and traffic signal controller cabinets should be placed outside the clear zone.

The specific lighting and traffic signal foundation size shall be shown in the plans for each foundation installed with the project. Refer to the table below for the specific foundation diameter and depth requirements for various lighting and traffic signals.

<b>LIGHTING &amp; TRAFFIC SIGNAL FOUNDATION TABLE</b>			
<b>(USE FOR SINGLE MAST ARMS ONLY)</b>			
<b>Description</b>	<b>Footing</b>	<b>Footing</b>	
	<b>Depth, "D"</b> 24" & 30" Ø <b>(ft)</b>	<b>Depth, "D"</b> 36" & 42" Ø <b>(ft)</b>	
<b>Light Standard</b>			
30'-35' Mounting Height	6	5	
36'-44' Mounting Height	6	5	
45'-50' Mounting Height	8	7	
<b>Type I, II, V, VI, VII Signal Standard</b>			
	4	3	
<b>Type IV Signal Standard</b>			
0'-25' Signal Mast Arm	11,11	11,11	
26'-30' Signal Mast Arm	12,12	12,12	
31'-35' Signal Mast Arm	12,12	12,12	
36'-39' Signal Mast Arm	13,13	13,13	
40'-45' Signal Mast Arm	16,15	15,15	
46'-50' Signal Mast Arm	16,16	15,15	
51'-55' Signal Mast Arm	17,16	16,16	
56'-60' Signal Mast Arm	18,17	17,17	
<b>Combination 30' Mounting Height</b>			
0'-25' Signal Mast Arm	11,11	11,11	
26'-30' Signal Mast Arm	12,12	12,12	
31'-35' Signal Mast Arm	13,13	13,13	
36'-39' Signal Mast Arm	14,14	14,14	
40'-45' Signal Mast Arm	16,16	15,15	
46'-50' Signal Mast Arm	17,16	16,16	
51'-55' Signal Mast Arm	17,17	16,16	
56'-60' Signal Mast Arm	18,18	17,17	

<b>LIGHTING &amp; TRAFFIC SIGNAL FOUNDATION TABLE</b>			
<b>(USE FOR SINGLE MAST ARMS ONLY)</b>			
<b>Description</b>	<b>Footing</b>	<b>Footing</b>	
	<b>Depth, "D"</b> 24" & 30" Ø <b>(ft)</b>	<b>Depth, "D"</b> 36" & 42" Ø <b>(ft)</b>	
<b>Combination 40' Mounting Height</b>			
0'-25' Signal Mast Arm	12,12	12,12	
26'-30' Signal Mast Arm	13,13	13,13	
31'-35' Signal Mast Arm	13,13	13,13	
36'-39' Signal Mast Arm	14,14	14,14	
40'-45' Signal Mast Arm	16,16	15,15	
46'-50' Signal Mast Arm	17,16	16,16	
51'-55' Signal Mast Arm	18,17	16,16	
56'-60' Signal Mast Arm	19,18	17,17	
<b>Combination 50' Mounting Height</b>			
0'-25' Signal Mast Arm	12,12	12,12	
26'-30' Signal Mast Arm	13,13	13,13	
31'-35' Signal Mast Arm	14,13	13,13	
36'-39' Signal Mast Arm	15,14	14,14	
40'-45' Signal Mast Arm	17,16	16,16	
46'-50' Signal Mast Arm	17,16	16,16	
51'-55' Signal Mast Arm	18,17	17,17	
56'-60' Signal Mast Arm	19,18	18,17	

**III-12.04 Span Wire Signals and Flashing Beacons**

The maximum span between support poles is shown in the table below for the number of heads (up to 5 section head) that can be supported. The span calculations are based on ½" – 7 strand steel cables with a 5% sag, Class II wood poles for supports, and soil anchors capable of resisting 12,000 lbs of tension at 30° and 24,500 lbs of tension at 15°.

Number of Traffic Signal Heads			
1	2	3	4
200 FT	185 FT	165 FT	145 FT

Note: Reducing the sag to less than 5% will significantly increase the tension in the wires and may cause failure.

If signing is required on the span wires, each sign would take the place of one head.

**III-12.05 Resources and References**

- The Traffic Signal Book
- Manual of Traffic Signal Design
- Traffic Control System Handbook
- The Highway Capacity Manual for Timing and Lane Assignments
- Manual on Uniform Traffic Control Devices
- Standard Specifications for Structural Supports for Highway Signs, Luminaires and Traffic Signals

**III-12.06 Standards and Standard Drawings**

The Manual on Uniform Traffic Control Devices (MUTCD) Part 4 covers Highway Traffic Signals. There are design features that are used frequently and these have been embodied in the 770 and 772 Standard Drawings which can be found on the web at:

<http://www.dot.nd.gov/dotnet/standarddrawings/std drawings.aspx>

*Standard Drawings D-764-5A to 17A and D-764-33 to 37 have been deleted and moved to the Design Manual as Appendix III-13B. Standard Drawing D-764-2B has been renumbered to D-764-4. Standard Drawing D-764-2C has been renumbered to D-764-6. Standard Drawing D-764-2D has been renumbered to D-764-5. Standard Drawing D-764-2H has been renumbered to D-764-7. Standard Drawing D-764-3 has been renumbered to D-764-9. Standard Drawing D-764-3A has been renumbered to D-764-10. Standard Drawing D-764-5 has been renumbered to D-764-11. Standard Drawing D-764-3B has been renumbered to D-764-13.*

### **III-13.01 Introduction**

These design procedures should be used after it has been determined that guardrail is warranted. Standards D-764-1 through D-764-37 should be used to determine the length of need and location of the guardrail and post spacing. The Standard Drawings can be found on the web at <http://www.dot.nd.gov/dotnet/standarddrawings/std drawings.aspx>. These design procedures should be used to determine the type of guardrail, the length of guardrail, and the position of the guardrail. The AASHTO Roadside Design Guide has been used for guidance in preparing these design procedures.

### **III-13.02 Design Speed**

The design speed should be determined according to the roadway classification. Generally, there are five classifications of roadway; 1) Rural/Urban Interstate; 2) Interregional System; 3) State Corridor; 4) District Corridor, and 5) District Collector.

The design speed should be obtained from Section I-06.

### **III-13.03 Lateral Clearance**

The lateral clearance from the roadway centerline to the edge of the obstacle should be determined.

The distance from the finished shoulder to the roadway centerline should also be determined. For new surfacing projects, this distance should be determined from the typical section for the new surfacing.

### **III-13.04 Obstacle Type**

There are several different types of obstacles. The type of obstacle will determine the type of guardrail to be used. Some of the different types of obstacles are as follows.

#### **III-13.04.01 Bridge Rail Ends**

These are near the roadway and should be treated with W-beam guardrail. The bridge rail should be an acceptable type of design and should have been crash tested in accordance with NCHRP Report 350.

The following types of bridge rail are acceptable and should have an acceptable end treatment for guardrail to bridge end connection:

- A. **Jersey Barriers:** The Jersey barrier bridge rail should have the W-beam guardrail attached to the bridge rail using the standard W-beam terminal connector and transitioning to the standard W-beam guardrail, as shown on Standard Drawing D-764-3. Further requirements of this design are discussed in Section III-13.05.01.A.
- B. **Double Box Beam Rail Retrofit:** Bridges with sloped curb (Code E) bridge rail or other deficient bridge railings, should be retrofitted with a double box beam bridge railing, with thrie beam guardrail connection plates.
1. **Bridge Rail Retrofit:** The retrofit bridge rail should have a thrie beam terminal connector plate for transition from the retrofit bridge rail to the thrie beam connector. A 12'-6" thrie beam, with a thrie beam to W-beam transition section, is installed between the thrie beam connector and the W-beam approach rail. These sections should be double thickness. The thrie beam to W-beam transition and connection details are shown in Standard Drawing D-764-3A.

#### III-13.04.02 Light Standards

These are usually made breakaway by providing a slip base or a frangible transformer base. High mast poles are usually placed outside the clear zone of the particular highway and need no safety treatment. Guardrail warrants would be determined by clearances between driving lane and the pole locations. The offset distance requirement will be discussed later in this design procedure.

#### III-13.04.03 Utility Poles

These are usually placed outside the clear zone of the particular highway. Guardrail for any poles that are within the clear zone will be discussed later.

#### III-13.04.04 Bridge Piers

These may be placed within the clear zone and may need guardrail. The type of guardrail will depend on the offset distance between the guardrail and the pier. The type of guardrail required is discussed in Section III-13.05.02.

#### III-13.04.05 Sign Supports

Sign supports are made breakaway or are a yielding type, except overhead sign structures. The overhead sign structures are treated like piers and will be discussed later.

#### III-13.04.06 Culverts

A single culvert (or end section) opening larger than 36" or multiple culvert (or end section) openings larger than 30" within the clear zone are considered obstructions. These culverts should be extended to the clear zone or guardrail should be installed. The type of guardrail will depend on the offset distance between the guardrail and the top of the culvert opening.

**III-13.04.07 Water**

Water is considered an obstacle if it is 2 or more feet deep and within the clear zone. In most cases, 3-cable guardrail is used to shield water areas.

**III-13.04.08 Trees**

Trees over 4 inches in diameter within the clear zone should have guardrail if they cannot be removed. The type of guardrail will depend on the offset from the guardrail.

**III-13.04.09 Rock or Rip Rap**

Rock or rip rap within the clear zone should be removed or moved outside the clear zone. If rocks or rip rap cannot be removed or moved, guardrail should be installed. The type of guardrail will depend on available offset between the guardrail and the rock or rip rap. In some instances where there is insufficient room to install guardrail because of a narrow roadway width, it may be necessary to post the area for reduced travel speed.

**III-13.04.10 Steep Slopes**

Steep slopes are studied during the safety review to determine if guardrail or flattening the slopes is cost effective. When guardrail is required, 3-cable guardrail is used unless there is another obstruction on the foreslope that is within 11 feet of the guardrail in which case W-beam guardrail is required.

### III-13.05 Treatment of Obstacle

#### III-13.05.01 Bridge Rail Ends

The clear roadway distance is obtained from the bridge plans. The bridge plans will also show the type of bridge rail that is in place. The two types of acceptable bridge rail have been specified in Section III-12.04.01.

##### A. Jersey Barrier

1. This type of rail requires a transition as shown on Standard Drawing D-764-3. A W-beam terminal connector is bolted directly to the jersey barrier for attachment of the approach guardrail. At each bridge corner where guardrail is required, a 6 inch high curb with height transitions shall be installed. The minimum length of the curb (including height transitions at each end) is 20 feet, and a maximum length of 25 feet may be installed. At the end nearest the jersey barrier, the curb shall transition to match the lower jersey barrier shape. At the end furthest from the bridge, the curb shall taper from 6" to 0" over a distance of 3 feet. Details of the required curb are shown on Standard D-764-3. On roadways where curb and gutter will extend beyond the 20 foot approach curb, the transition curb height shall taper down from 6" to 3" maximum. On roadways where additional curb is required beyond the transition curb, the lower 3" curb height shall be provided for a distance equal to the length of the guardrail embankment area as shown on Standards D-764-9B through D-764-13. At the location where the 4:1 taper for the embankment meets the face of curb, the curb height may then be transitioned back up to a standard 6" curb height. The length of the height transition at this location should be a minimum of 2 feet in length.
  - a. Where a bridge approach slab is placed, the Bridge Division will provide the curb on the slab. If no approach slab is to be placed, the guardrail designer will provide for the curb in the guardrail plans.
    1. Where no additional curb is installed beyond the minimum 20 foot long transition curb, drainage shall be carried down the foreslope from the curb end, and the foreslope shall have turf reinforcement mat installed in accordance with Standard Drawing D-708-4.
      - a. At locations where the existing foreslope will not be disturbed, and adequate turf exists to prevent erosion, consideration may be given to omitting the turf reinforcement mat.
    2. At some locations, inlets may be provided within the 20 foot long transition curb. Where necessary, these must be carefully sized and located between the guardrail posts, which have a maximum center to center spacing of 3'-1 1/2" in the area where the curb is installed. Drainage from inlets installed at these locations



shall be carried through underground drains to the bottom of the foreslope.

3. If inlets are required beyond the 6" tall transition curb, they must be of a type which has a curb box that is adjustable to allow installation in the 3" curb required in these areas, or the curb may be transitioned to a mountable type, and mountable inlets may be installed.

4. When no approach slab is in place and curb and gutter is in place, the curb and gutter should be removed, or if possible, modified to conform to the requirements as shown on Standard Drawing D-764-3. When drainage is provided by using drop inlets, the inlets should be treated as discussed in 2 and 3 above.

B. Double Box Beam Bridge Rail Retrofit

Several types of existing bridge rail can be retrofitted with double box beam railing which has been crash tested in accordance with NCHRP 350. The bridge designer provides the plans for retrofit bridge railing. The approach rail for the retrofit bridge rail should start with a thrie beam terminal connector attached to the attachment plate on the retrofit bridge rail. A double thickness, 12'-6" section of thrie beam is attached to the terminal connector using splice bolts. The post spacing on this section of thrie beam is 1'- 6 3/4" except the last space (between the 6<sup>th</sup> and 7<sup>th</sup> post) before the thrie to W-beam transition section is 3'-1 1/2". The next section is a 6'-3" thrie beam to W-beam transition section with a post spacing of 3'-1 1/2" and is also double thickness. For details, see Standard Drawing D-764-3A, "Thrie Beam to W-Beam Transition and Connection to Double Box Beam Retrofit." The thrie beam to W-beam transition section is connected to the thrie beam and W-beam with splice bolts.

1. Where a thrie beam to W-beam transition is used in conjunction with double box beam bridge rail retrofit, as described above, any curb and gutter installed within the guardrail area, from the end of the embankment taper to the beginning of the bridge, shall be either curb and gutter having a maximum curb height of 3" or mountable curb having a maximum curb height of 3". When curb and gutter is installed, the width of the curb should be modified to 5" maximum, to avoid conflict with the installation of guardrail posts. If mountable curb is installed, the location of the curb, and the flow line will require adjustment to avoid conflict with the installation of guardrail posts. The preferred option is generally the standard Type I curb and gutter with a modified 3" curb height.

C. Bridge rails may have to be updated temporarily by placing retrofit bridge rail.

1. The guardrail transition for an installation of this type is as described above in B.

D. Bridge End Treatments with speeds under 30 mph.

1. The type of bridge rail will determine what is required.
  - a. At design speeds of less than 30 mph, where jersey barrier type bridge rails exist or are to be used, a 20 foot long transition wall can be provided which transitions from the 32" jersey barrier shape to a standard Type I curb shape (6" curb height). This transition is typically provided as part of a bridge approach slab. If no curb exists, the wall transitions to a height of 4" or less. This treatment is for use only at low speed locations such as urban areas where site conditions such as pedestrian facilities adjacent to the roadway, limit the available end protection options.
  - b. Double box beam bridge rail retrofit does not have an acceptable tapered down transition for speeds of less than 30 mph. It is recommended that guardrail be installed. The transition as described in B. above, and as shown on Standard Drawing D-764-3A should be provided, with approach guardrail length of need provided in accordance with Standard Drawing D-764-5A.
2. Reduction in posted speed to 25 mph for the sole purpose of elimination of guardrail at bridge ends, or other obstructions is generally not recommended. If the prevailing speeds at the bridge are greater than 45 mph, there should be no reduction of speed to eliminate guardrail or reduce guardrail length. Motorists will tend to exceed what they perceive to be over-restrictive speed limits when these speed reductions are not otherwise consistent with the general roadway conditions.

**III-13.05.02 Bridge Piers**

Bridge piers that are within the clear zone require shielding. Shielding of median piers on divided highways, where they lie within the clear zone of both roadways may be accomplished by use of vertical concrete walls or jersey barriers with attenuation devices or crash cushions, or by installation of guardrail. The type of guardrail which may be used will depend on lateral clearance from the guardrail to the piers.

- A. When piers are less than 1'-3" from the finished shoulder, a Jersey type barrier should be placed directly against the pier and the Jersey barrier should run from outside of the pier to outside of the pier, and be 42" in height. The Jersey barrier should then transition down in 10' to the height of 32". A curb and gutter shall be installed on the approach end of the Jersey barriers as shown on Standard Drawing D-764-3. The W-beam is bolted to a W-beam terminal connector, which is bolted directly to the Jersey barrier as shown on Standard Drawing D-764-3. On non-divided roadways, a height transition, and a curb and gutter shall be placed in both directions. See Figures 1-3 in Appendix III-13 A.
- B. When bridge piers are between 1'-3" and 3' from the finished shoulder, W-beam guardrail should be used. The post spacing of the W-beam guardrail should be reduced to 3'-1 1/2" from 25' in advance of the piers and past the pier area. The last section beyond the piers should have 6'-3" post spacing and a breakaway cable treatment should be used in the last 6'-3" post spacing section. See Figure 13 in Appendix III-13 A.
- C. When bridge piers are 3' to 11' from the guardrail, W-beam guardrail should be used with 6'-3" post spacing throughout. The last 6'-3" post spacing past the pier should have a breakaway cable treatment. See Figure 13 in Appendix III-13 A.
- D. When piers are over 11' from the finished shoulder, 3-cable guardrail should be used because of reduced installation cost and reduced snow accumulations. The 3-cable guardrail should be placed 9' from the driving lane on the median side of divided roadways as long as 11' or more minimum clearance can be maintained between the cable and the face of the pier. The 3-cable guardrail should be placed on a slope of 10:1 or flatter when placed in this position. The 10:1 or flatter slope should be carried 3' behind the guardrail (measured from the cable). The area outside the 10:1 slope should be graded to drain away from the piers. Some culvert extension or installation may be needed.
- E. Where there are median piers and both roadways are at nearly the same elevation, one of the following treatments should be installed:
  1. Where piers are set on top of a rectangular footing having a continuous, smooth face, the top of which is at least 42" above the final finished surface after the median is filled:

The median should be filled to provide a flat area wide enough to provide a minimum of 5 feet of flat area (measured perpendicularly from the device toward the roadway) adjacent to a Type B attenuation device when this type of end protection is installed. Where a crash cushion will be used to shield the barrier end, provide a minimum width of 5 feet of flat area adjacent to the median bridge

pier for the entire length of the median pier protection embankment. From this point the fill should be placed at a 12:1 or flatter slope to the finished edge of the shoulders.

Vertical faced transition walls shall be installed at each end of the pier footing, having a height of 42" or higher at the face of the pier foundation, and tapering down to a height of 32" above the finished surface, and a width of 24". The top of the transition wall shall taper at a rate of 10:1 or flatter slope. The traffic faces of the transition wall shall have a taper rate consistent with, or flatter than, the suggested flare rates for barrier design for rigid barrier systems, as given in Table 5.7 of the 2002 AASHTO Roadside Design Guide. The values in Table 5.7 are given for design speeds from 30 mph to 70 mph. Where a design speed of 75 mph applies, the taper rate for concrete transition walls shall be 23:1 or flatter. An additional 2 feet of wall 32" high by 24" wide shall extend beyond the end of the height transition, and the last 5 feet of the transition wall shall be 24" wide, to accommodate the rearward movement of crash cushion side panels when impacted. The barrier walls and transitions shall be reinforced.

The end of these types of transition walls may be shielded by either an attenuating crash cushion meeting the crash test requirements of NCHRP Report 350 (TL3), installed on a concrete pad, or a Type B attenuation device, as shown on Standard Drawing D-704-1. The type B attenuation device when permanently installed shall be placed on a concrete pad. Permanent installations of this type are described with pay items "Barrel Attenuation Device Type B-(speed, mph). Concrete pads for attenuating crash cushions shall be specified to be as recommended by the crash cushion manufacturer.

See Figures 3-7 in Appendix III-13 A.

2. Where piers are set on footings below the ground, or where the pier footing is less than 42" above the final finished surface:

The median should be filled to provide a flat area wide enough to provide a minimum of 5 feet of flat area (measured perpendicularly from the device toward the roadway) adjacent to a Type B attenuation device when this type of end protection is installed. Where a crash cushion will be used to shield the barrier end, provide a minimum width of 5 feet of flat area adjacent to the jersey barrier for the entire length of the median pier protection embankment. From this point the fill should be placed at a 12:1 or flatter slope to the finished edge of the shoulders.

A 42" high Jersey barrier will be placed from end of pier to end of pier on both sides of the piers. The 42" high Jersey barrier walls shall be tapered down to a 32" height, and the traffic faces shall be tapered at a rate consistent with, or flatter than the suggested flare rates for barrier design for rigid barrier systems, as given in Table 5.7 of the 2002 AASHTO Roadside Design Guide. The values in Table 5.7 are given for design speeds from 30 mph to 70 mph. Where a design speed of 75 mph applies, the taper rate for concrete barrier walls shall be 23:1 or flatter.

The length of the barrier transition will vary depending upon the width of the pier foundation. The top width of the Jersey barrier face (at the pier) shall be tapered to 1'-8" near the end of the transition. The barrier then transitions, over a distance of 7'-6 <sup>3</sup>/<sub>4</sub>" to a 24" wide by 32" tall rectangular shape. Two additional feet of the rectangular wall shape are required at the end of the transition. The barrier walls and transitions shall be reinforced.

The end of these types of barrier walls may be shielded by either an attenuating crash cushion meeting the crash test requirements of NCHRP Report 350 (TL3), installed on a concrete pad, or a Type B attenuation device, as shown on Standard Drawing D-704-1. The type B attenuation device when permanently installed shall be placed on a concrete pad. Permanent installations of this type are described with pay items "Barrel Attenuation Device Type B-(speed, mph)." Concrete pads for attenuating crash cushions shall be specified to be as recommended by the crash cushion manufacturer.

See Figures 8-12 Appendix III-13 A

### **III-13.05.03 Sign Supports**

Sign supports usually are made of breakaway or yielding type material. In some cases, overhead sign structures are utilized and their end towers and foundations may need guardrails or have Jersey barrier and crash cushion placed when the end towers and foundations are within the clear zone. The overhead sign structure end tower and foundation should be shielded by guardrail, or have Jersey barriers and crash cushions installed, when warranted, using the same criteria as used for bridge pier protection.

### **III-13.05.04 Culverts**

The location of the culvert end openings will determine the type of guardrail. The same criteria used for piers will determine the type of guardrail to be used. Single centerline culverts having openings of greater than 36" in width, or multiple culverts having greater than 30" width openings that are within the clear zone, will require either extension of the culvert, or the installation of guardrail. Centerline culvert ends 15 to 36 inches in diameter can be within the clear zone if they have a traversable end section. Culverts installed parallel to the roadway, such as those through approaches, can be within the clear zone if they have a traversable end section. The details for traversable end sections can be found on Standard Drawing D-714-1 on the NDDOT web site.

### **III-13.05.05 Water**

Water areas may be shielded by 3-cable type guardrail in most cases, provided that rip rap or other obstructions are outside the 11-foot deflection distance. W-beam guardrail must be used where obstructions lie within 3 to 11 feet of the railing.

### III-13.05.06 Rock Outcroppings

The location of the obstacle will determine the type of guardrail to be used. The same criteria used for guardrail at piers should be used.

### III-13.05.07 Steep Slopes

Steep foreslopes warranting guardrail will normally require the use of 3-cable guardrail. Foreslopes 3:1 or steeper require guardrail. A foreslope steeper than 2:1 will require shielding with W-beam guardrail because errant vehicles could under-ride the cables of the 3-cable guardrail system at or near the maximum deflection on slopes steeper than 2:1.

### III-13.06 Guardrail Location

- A. W-beam guardrail should be placed at bridge ends or barrier walls. The straight sections should be aligned with the face of the barrier wall or the flat plate of the retrofit bridge rail.
- B. W-beam guardrail installed at locations other than bridge ends should be placed at the finished shoulders with the front face of the guardrail aligned with the finished shoulder. In no case should the slope in front of the W-beam guardrail be greater than a 10:1 slope. Where piers are close to the roadway, and a barrier wall is to be installed, the alignment should be as stated above for W-beam guardrail placed at bridge ends.
- C. W-beam guardrail may be flared away from the roadway at the flare rate shown on the standard drawings, dependent on the design speed. In all cases, a curved section will transition the straight section to the flared section. A minimum length of 25 feet of tangent railing shall be installed in advance of an obstruction, such as a pier, culvert, rock outcrop, overhead sign structure, steep slope, etc., before the curved rail section and flared rail are installed. See Standard Drawings D-764-13B through D-764-17A.
- D. Some locations may have conditions that will not allow W-beam guardrail to be flared at the standard taper rates. When conditions such as drainage, right of way, or possible clear zone violation for opposing traffic lanes (such as at median installations on divided highways) will not allow the W-beam guardrail to be flared at the taper rates given on the standard drawings, the guardrail should be installed either straight along the shoulder, parallel with the traveled lane, or wherever possible, should be flared at a rate flatter than the standard taper rates. A 50:1 taper rate has been used at many locations by NDDOT to accommodate unusual field conditions such as those discussed above.
- E. Box beam guardrail should be placed at the finished shoulder with the front face of the guardrail aligned with the finished shoulder break. In no case should the slope in front of the box beam guardrail be greater than a 10:1 slope. The box beam guardrail shall have an NCHRP Report 350 crash-tested end terminal installed, such as the Wyoming Box Beam End Terminal (WYBET). Presently, box beam guardrail is rarely used on North Dakota highways. It is not currently supported by the NDDOT standard drawings.

- F. 3-cable guardrail should be placed 2' from the finished shoulder, but should be at least 2' inside of the graded shoulder. Where the roadway slough is steeper than 10:1, fill should be placed, at a 10:1 slope, from the finished shoulder to 3' behind the 3-cable guardrail. On divided highways where piers are protected with 3-cable guardrail, the 3-cable guardrail should be placed 9' from the edge of the driving lane on the median side, but no closer than 11' from the face of the pier. In most cases, fill will be required for placement of the 3-cable guardrail at that point. The fill area between the finished shoulder and 3' beyond the 3-cable guardrail location should be 10:1 or flatter. Drainage may have to be modified for installation of the 3-cable guardrail at the 9' offset. 3-cable guardrail will only be used in the median where the finished elevations of the two roadways differ to the extent that median protection using either the vertical concrete wall or the jersey barrier installation cannot be installed. The wide flat area required for the installation of these systems, especially when attenuation devices are installed, will in some cases prohibit their use when roadway elevations differ.

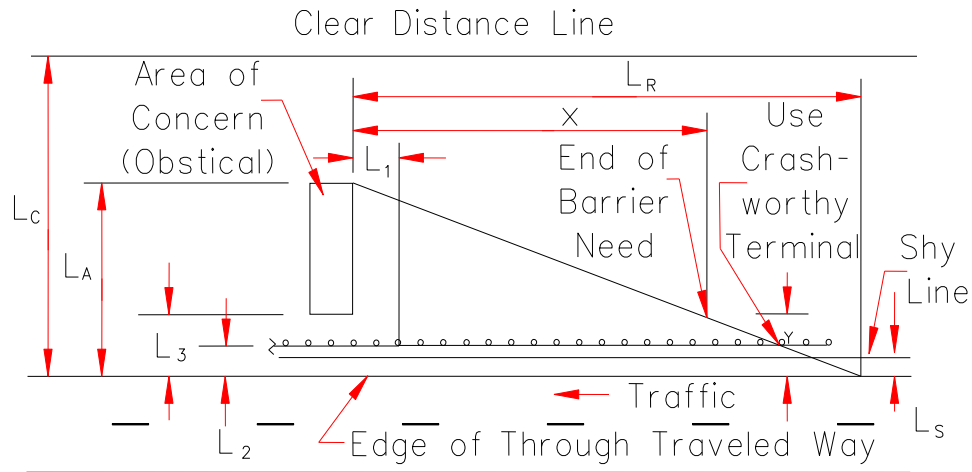
### III-13.07 Length of Need

#### III-13.07.01 Bridge End Treatment

- A. The W-beam guardrail should be carried 39'- 4 3/4" straight as shown on the layouts for the various design speeds, on Standard Drawings D-764-5A through D-764-9A. The end terminal should be one of those shown in Standard Drawings D-764-2B, D-764-2C, or D-764-2H. The acceptable end terminal type or types will be specified in the plans depending upon guardrail taper rate, or length of the installation. The criteria for determining the proper end terminal options at a given location is discussed in section III-13.11.
- B. The bridge end connection will depend on the bridge rail. Jersey barrier bridge rails should have the W-beam bolted to a W-beam terminal connector which is bolted directly to the Jersey barrier as shown on Standard Drawing D-764-3.
- C. When the bridge railing is a double box beam rail retrofit, the straight section should begin on the bridge with the thrie beam terminal connector, which attaches to the retrofit attachment plate. The thrie beam and thrie to W-beam transition should be installed as shown on Standard Drawing D-764-3A. The straight section, from the beginning of the thrie beam terminal connector to the curved section shall be at least 45'-7 3/4."
- D. When drainage or other constraints won't allow the W-beam guardrail to be flared at the standard taper rates, with the required 10:1 sloped embankment slope, the W-beam guardrail should be installed either at a flatter than standard taper rate, or straight, as was discussed in III-13.06. The length of need should be determined by the traffic volume, design speed, bridge clear roadway, and clear zone.

When guardrail is to be installed straight (non-flared), the length of need can be determined from the following equation:

$$X = (LA - L2)/(LA/LR)$$



Where  $L_A$  is the clear zone because at most bridge structures, steep slopes, water, or other obstacles lie behind the bridge railing, so shielding to protect out to the clear zone is necessary.  $L_2$  is the clearance between the edge of the travel way and the guardrail.  $L_R$  is the runout length.

Traffic Volumes (ADT)				
Design Speed (mph)	Over 6000 vpd	2000-6000 vpd	800-2000 vpd	Under 800 vpd
	Runout Length $L_R$ (ft)	Runout Length $L_R$ (ft)	Runout Length $L_R$ (ft)	Runout Length $L_R$ (ft)
75	520	485	430	395
70	475	445	395	360
65	450	425	370	345
60	425	400	345	330
55	360	345	315	280
50	330	300	260	245
45	260	245	215	200
40	230	200	180	165
30	165	165	150	130

**Suggested Runout Lengths for Barrier Design**



Design Speed (mph)	DESIGN ADT	FORESLOPES					BACKSLOPES						
		Flatter than 6:1	6:1	5:1	4:1	3:1	Steeper than 3:1	3:1	4:1	5:1	6:1	Flatter than 6:1	
40 or less	Under 750	7 - 10	7 - 10	7 - 10	7 - 10	**	7 - 10	7 - 10	7 - 10	7 - 10	7 - 10	7 - 10	7 - 10
	750 - 1500	10	12	12	14	**	10 - 12	10 - 12	10 - 12	10 - 12	10 - 12	10 - 12	10 - 12
	1500 - 6000	12	14	14	16	**	12 - 14	12 - 14	12 - 14	12 - 14	12 - 14	12 - 14	12 - 14
	OVER 6000	14	16	16	18	**	14 - 16	14 - 16	14 - 16	14 - 16	14 - 16	14 - 16	14 - 16
45 - 50	Under 750	10	12	12	14	**	8 - 10	8 - 10	8 - 10	8 - 10	10	10	12
	750 - 1500	14	16	16	20	**	10	12	12	14	14	16	16
	1500 - 6000	16	18	20	26	**	12	14	14	16	16	18	18
	OVER 6000	20	22	24	28	**	14	16	18	20	20	22	22
55	Under 750	12	14	14	18	**	8	10	10 - 12	10 - 12	10 - 12	10 - 12	10 - 12
	750 - 1500	16	18	20	24	**	10	12	14	16	16	18	18
	1500 - 6000	20	22	24	30	**	14	16	16	18	20	22	22
	OVER 6000	22	24	26	32	**	16	18	20	22	22	24	24
60	Under 750	16	18	20	24	**	10	12	12	14	14	16	16
	750 - 1500	20	24	26	32	**	12	14	16	18	20	22	22
	1500 - 6000	26	30	32	40	**	14	18	18	22	24	26	26
	OVER 6000	30	32	36	44	**	20	22	24	26	26	28	28
65 - 70	Under 750	18	20	20	26	**	10	12	14 - 16	14 - 16	14 - 16	14 - 16	14 - 16
	750 - 1500	24	26	28	36	**	12	16	18	20	20	22	22
	1500 - 6000	28	32	34	42	**	16	20	22	24	26	28	28
	OVER 6000	30	34	38	46	**	22	24	26	30	28	30	30
75	Under 750	19	22	24	29	**	12	14	14	17	17	19	19
	750 - 1500	25	30	32	40	**	15	17	20	22	25	27	27
	1500 - 6000	32	36	39	49	**	17	22	22	27	29	32	32
	OVER 6000	37	39	44	54	**	24	27	29	32	32	34	34

**Clear Zone Table  
For Guardrail Length of Need Determination**

The length of need tables in the Standard Drawings for guardrail were developed based upon the clear zone values given above, for 6:1 foreslope, in all cases. It was found that the weighted average foreslope rate that an errant vehicle travels across a runout path consisting of a 4:1 slope in advance of the guardrail embankment area, and the 10:1 foreslope of the embankment in advance of the guardrail was very nearly 6:1. Therefore, for standardization, the 6:1 values were used in developing the lengths of need for guardrail. Since a 10:1 foreslope is provided in advance of flared guardrail, the use of the 6:1 clear zone values, for graphical analysis, when the Standard Drawings are not used, or not applicable, should provide results comparable to the lengths of need provided by the Standard Drawings.

### III-13.07.02 Obstacles

The treatment of the various types of obstacles will depend on the lateral clearance.

- A. Objects within 0 to 1'-3" from the roadway finished shoulder should have a barrier wall installed with the W-beam guardrail as was discussed in III-13.05.02 A. The guardrail length of need should be determined from Standard Drawings D-764-5A through D-764-9A for bridge ends.
1. On divided highways, the 42" barrier wall should be installed only to the end of the obstacle on the exiting end.
  2. The W-beam should be attached to the 32" barrier wall at both ends on two-way roadways and on the upstream, approach end on divided highways.

- B. Obstacles 1'-3" to 3' from the roadway finished shoulder should have W-beam guardrail installed with reduced post spacing. The post spacing for the railing in front of, and for 25 feet in advance of the obstruction, shall be 3'-1 ½".
1. On non-divided highways, the straight portion of the W-beam rail in the vicinity of the obstacle shall be determined by taking the length of the obstacle, and rounding this up to the nearest length which is divisible by 12'-6". An additional length of 25 feet is added to each end. This total straight portion is installed symmetrical about the centerline of the obstacle. This is illustrated in the W-beam guardrail dimension layout, on Standard Drawings D-764-13B through D-764-17A.
  2. On divided highways, the straight portion of the W-beam rail in the vicinity of the obstacle shall be determined by taking the length of the obstacle, and rounding this up to the nearest length which is divisible by 12'-6". This portion of the straight railing is installed symmetrical about the centerline of the obstacle, and shall have 3'-1 ½" post spacing. An additional length of 25 feet of railing, having 3'-1 ½" post spacing is added to the upstream, approach end, before a curved rail section and flared rail with end terminal is installed. At the downstream end, an additional 12'-6" section with 6'-3" post spacing is installed, just beyond the obstacle, with a breakaway cable terminal end in the last 6'-3".
- See Figure 13 in Appendix III-13 A.
- C. Obstacles 3' to 11' from the roadway finished shoulder should have W-beam guardrail installed.
1. The guardrail along the obstacle should have the length calculated as specified in B 1 above, except all post spacings may be 6'-3" for obstacles 3' or more behind the face of the W-beam guardrail.
  2. The guardrail for divided highways should be as specified in B 2 above, except all post spacings may be 6'-3" for obstacles 3' or more behind the face of the W-beam guardrail.
- D. Objects over 13' from the roadway finished shoulder should have 3-cable guardrail installed.
1. 3-cable guardrail should be placed 2' from the finished shoulder, but not closer than 2' to the graded shoulder. To ensure the 2' to the graded shoulder, the distance from the 3-cable guardrail to the finished shoulder could be less than 2'.
- E. On divided highways where median piers are protected with 3-cable guardrail, the 3-cable guardrail should be placed 9' from the edge of the driving lane on the median side but no closer than 11' from the face of the pier. In most cases, fill will be required for placement of the 3-cable guardrail at that point. The fill area between the finished shoulder and 3' beyond the 3-cable guardrail location should be 10:1 or flatter. Drainage may have to be modified for installation of the 3-cable guardrail at the 9' location. 3-cable guardrail will only be used in the median where the finished elevations of the

two roadways differ to the extent that median protection using either the vertical concrete wall or the jersey barrier installations cannot be installed. The wide flat area required for the installation of these systems, especially when attenuation devices are installed, will in some cases prohibit their use when roadway elevations differ.

### III-13.08 Guardrail Design

The design of the guardrail for a particular type of obstacle uses each of the above sections to obtain the proper design. The following information should be obtained for each location.

- A. The designer should determine the type of obstacle.
  - 1. Bridge ends: Obtain bridge rail plans.
  - 2. Piers and bridge layout: Obtain bridge layouts and pier plans.
  - 3. Culverts: Obtain plan and profile sheets.
  - 4. Steep slopes: Obtain plan and profile sheets.
  - 5. Water: Obtain plan and profile sheets.
  - 6. Other: Obtain plan and profile sheets.
- B. The designer should obtain the design speed for the roadway. Guardrail design speeds used by NDDOT are: 30 mph, 40 mph, 45 mph, 50 mph, 55 mph, 60 mph, 65 mph, 70 mph and 75 mph.
- C. Lateral clearance from the roadway centerline to the obstacle should be determined. Obtain the cross sections of the roadway in the area that guardrail is warranted.
- D. The traffic volumes should be obtained from the plan title page or from the Planning/Asset Management Division.

### III-13.09 Design Procedures

The following design procedures should be followed, dependent on the type of obstacle, using the above information.

#### III-13.09.01 Bridge Ends

The designer should use W-beam guardrail at these locations and the length of need should be obtained from Standard Drawings D-764-5A to D-764-9A, dependent on design speed.

- A. The type of bridge end treatment should depend on whether the bridge has a jersey barrier rail or a double box beam rail retrofit.

1. **Jersey Barrier**
    - a. The requirements for the transition railing, including curb requirements, were discussed in III-13.05.01 A, and the transition is shown on Standard Drawing D-764-3.
  2. **Double Box Beam Bridge Rail Retrofit**
    - a. The requirements for the guardrail transition railing, including curb requirements, if curb is needed, were discussed in III-13.05.01B, and the transition is shown on Standard Drawing D-764-3A.
- B. The length of need is taken from Standard Drawings D-764-5A to D-764-9A, dependent on design speed.
1. Entering the table on the appropriate standard drawing with the bridge width and traffic volume, read across the standard drawing to determine the various guardrail dimensions for that bridge width and traffic volume.
  2. The bridge on a two-way roadway should have the length of guardrail shown on the approach side and opposite side. The guardrail should have the end terminals as shown on Standard Drawings D-764-2B, D-764-2C or D-764-2 H. Dimensions C or C1 give the length of the end terminal.
  3. Where an approach falls within this length, the approach should be moved. The district office should determine if the approach can be moved.
  4. If the approach cannot be moved, the guardrail should be broken, with a minimum of either 39'-4 <sup>3</sup>/<sub>4</sub>" (at bridges with Jersey barrier) or 45'-7 <sup>3</sup>/<sub>4</sub>" (at bridges with double box beam rail retrofit) straight section and an end terminal, as shown on Standard D-764-2B, D-764-2C or D-764-2H, installed in the vicinity of the radius of the approach roadway as a minimum. If additional guardrail can be installed, then extend the rail with additional straight W-beam rail sections, to place the end terminal in the vicinity of the approach radius. The guardrail length need should be provided by placing a length of guardrail on the other side of the approach to the required length, and an end treatment as shown on Standard D-764-2B, D-764-2C, or D-764-2H shall be installed on both ends of the guardrail. The length of need shall include the end treatments minus the first 12.5 feet from the end of the terminal ends that may be hit by errant vehicles. The end treatment at the approach should begin at a point approximately 5 feet from the vehicle turning radius. The end treatment shall have the offsets as shown on the standard drawings. For private drives or field drives, a general rule of thumb is that the access opening between the guardrail ends should be approximately 60 feet. Adjacent land use, skew angle of the approach, and turning movements should be considered in determining the opening.

On low-volume, low-speed roadways a curved rail may be placed as shown on Standard Drawing D-764-3B. The speeds on the main roadway shall be 55 mph or less and the 750 ADT or less.

5. Where roadside constraints, such as drainage, do not allow for flaring the guardrail at standard taper rates (10:1 for 30 mph to 45 mph, 11:1 for 50 mph, 12:1 for 55 mph, 14:1 for 60 mph, 15:1 for 65 mph and 70 mph, and 16:1 for 75 mph), the guardrail should be installed at a flatter taper rate. Any taper rate which is flatter than that prescribed for a given design speed is acceptable. The standard taper rates are maximum taper rates. This means that if right of way restrictions limit the available guardrail offset, a flatter taper rate could be used to install the rail. However, the length of the railing would likely require adjustment. This can best be accomplished by graphical means. Refer to Section 5.6.4 of the 2002 AASHTO Roadside Design Guide. A 50:1 taper rate has been used by NDDOT at many high speed locations, to allow for a reasonable length of guardrail to be installed which satisfies length of need requirements. Alternately, straight guardrail can be installed, which further increases the length of rail required. This type of installation is not preferred, as increased nuisance hits are likely, and snow buildup on the roadway may be increased.

If an approach is encountered in this length, it should be treated as stated above. Wherever possible, approaches should be relocated rather than providing breaks in the guardrail installation.

6. For length of guardrail needed for double box beam rail retrofit installations, the straight approach length is revised from the 39.4' shown in the length of need tables, to 45.65'. This increases the total length given in the table, by 6.25 feet.
- C. Flared guardrail (and most straight guardrail installations) will require fill material provided to place the guardrail on, as shown on Standard Drawings D-764-9B through D-764-13A. It should be noted that this fill area should be installed from the finished shoulder to 3' behind the guardrail, and this area should be 10:1 or flatter. The foreslope in advance of the end treatment should be equal to the foreslope it is matching. The foreslope behind the guardrail, between the downstream end of the end terminal (beginning of flared W-beam rail) and the beginning of the bridge may be steepened if necessary to accommodate the fill.
- D. Where guardrail is provided on divided highway bridges, the guardrail length is determined as stated above. However, the distance from the approach roadway centerline to the bridge rail face (lowest face of jersey barrier), times two, should be the clear roadway width used for that side of the roadway. Use this and the traffic volumes. For example, if an interstate highway bridge has two twelve foot lanes, an outside shoulder of 10 feet, and a passing lane (median side) shoulder of 4 feet, then the clear roadway width to use for the outside driving lane is:  $(12 + 10) * 2 = 44$  feet. The clear roadway width to use for the passing lane is:  $(12 + 4) * 2 = 32$  feet. Both of these would be considered an approach side, because traffic is using both lanes entering the bridge, and length of need is taken for each side, from the appropriate clear roadway width lines in the length of need table.

### III-13.09.02 Obstacles

The designer should use the guardrail type, dependent on guardrail offset from the roadway driving lane, and the clear distance from the obstacle. The W-beam guardrail should be flared, if possible. All obstacles should have a minimum of 25' of straight guardrail in advance of the obstruction and 25' past, except on divided highways, the length past the obstacle can be reduced to 12'-6" when a cable anchor is installed. 3-cable guardrail should not be placed on the inside of curves with curvature of more than 4 degrees. Intermediate anchors should be installed as specified on the standard drawings.

### III-13.10 Design Procedures For Guardrail On The Outside of Horizontal Curves

The design of W-beam guardrail on the outside of horizontal curves depends upon the degree of curvature of the roadway.

- A. For all curves of 1 Degree 15 minutes ( $R = 4583.66'$ ) or flatter, the layout of the W-beam guardrail for the outside of the curve may be established in accordance with the Standard Drawings for guardrail length of need. Adjustments to the longitudinal dimensions (measured parallel to centerline of roadway) given by the standard drawings will be required, to correct for the difference between the roadway curvature and the tangent lengths given, to allow for proper layout in the field. The offset dimensions determined from the standard drawings may be used, however the dimension "D" given for the offset of the approach end of the W-beam guardrail end terminal should be adjusted, to allow the end terminal to be installed tangent to the downstream flared (or straight) guardrail. This may be done graphically by establishing the straight tapered portion of the rail relative to the roadway using the offset dimension "B" given in the standards, and extending a line coincident with the rail for a distance of 50 feet. The offset measured from the end of this 50 foot extension, (which is coincident with the end of the end terminal) to the centerline of the roadway is the appropriate offset dimension to use in lieu of utilizing the "D" offset dimension given in the standard drawings. In this way, the end terminal will remain tangent to the downstream guardrail.
- B. Guardrail to be installed on the outside of curves sharper than 1 Degree 15 minutes ( $R < 4583.66'$ ) will require a graphical design procedure to assure that length of need is provided, and that the anticipated vehicle impact angle with the guardrail does not exceed 10 degrees.

This procedure is largely equivalent to the procedure discussed in the Roadside Design Guide 2002, page 5-42. The fundamental difference between this procedure and the Roadside Design Guide method, is that, for most horizontal curves, when using the method described here, some limited flaring of the guardrail is achieved relative to the roadway curvature. The use of a shallow flare for the guardrail results in a decrease in guardrail length of need, as compared to a parallel guardrail installation. The advantages of this type of installation include decreased snow accumulation and fewer nuisance hits. The flaring provided by this method shall be limited to provide an anticipated vehicle impact angle with the guardrail of no more than 10 degrees. Most often, an impact angle ranging between 7 and 8 degrees has been used by NDDOT. This angle is determined most easily by simple graphical means. A design example is illustrated below.

1. **Design Example**

See Figure 14 in Appendix III-13 A

In this example, a bridge is located within a 2 degree 10 minute horizontal curve ( $R=2644.42'$ ). The roadway inslopes are 6:1. Design speed is 70 miles per hour and forecast ADT = 1000. The bridge has a clear roadway width of 40 feet.

First, the clear zone is determined. Since the horizontal curve is 2 degrees, 10 minutes, a clear zone correction factor of 1.3 (See Table 3.2, Roadside Design Guide, 2002, or NDDOT Design Manual) is applied to the value obtained from Table 3.1 of the Roadside Design Guide or from the Clear Zone table in the NDDOT Design Guide. Clear zone for a tangent roadway with the above design values, is given as 26 feet. With horizontal curve correction, the clear zone at this location is:  $1.3 \times 26' = 33.8$  feet from the edge of the driving lane, or 45.8 feet from the roadway centerline.

The method for determining the design runout path is as follows: First, a line is drawn perpendicular from roadway centerline, at the beginning of the bridge, toward the outside of the curve, for a distance of  $33.8' + 12' = 45.8'$ . A curve is drawn or offset 12 feet from the centerline, to establish the edge of the driving lane in advance of the bridge end. Next, from the end of the perpendicular line, at the clear zone, a line is drawn upstream to meet the edge of the driving lane on a tangent. This line is known as the Tangential Runout Path. The distance from the point of tangency is measured, along the edge of the driving lane, to the beginning of the bridge. This distance is then compared to the Suggested Runout Length, given in Table 5.8, page 5-33 of the Roadside Design Guide, 2002, or NDDOT Design Manual. If the measured distance is less than the Suggested Runout Length, then the Tangential Runout Path shall be used to determine the guardrail length of need. However, if the distance measured along the edge of the driving lane, from the point of tangency to the beginning of the bridge is greater than the Suggested Runout Length, then the Suggested Runout length shall be used to determine the guardrail length of need. This is accomplished by drawing an arc of a length equivalent to the Suggested Runout Length, from the beginning of the bridge upstream along the edge of the driving lane. From the end of this arc, a line is drawn to the clear zone point previously established, on the outside of the curve, adjacent to the bridge end.

Once the runout path has been established, as described above, the approach guardrail is extended parallel to the roadway for a portion of its length, then continued on a tangent, resulting in a shallow flare relative to the curving roadway. The distance that the rail is required to run parallel to the horizontal curve is determined graphically, by measuring the angle between the runout path and the guardrail. This angle must be 10 degrees or less. Generally, flatter angles of 7 to 8 degrees are preferred, and can be achieved without providing excessive guardrail length.

In this example, the guardrail was run parallel to the curved roadway for the first 64.4 feet, then continues on a tangent. The angle between the runout path and the approach guardrail in this example is 7 degrees 45 minutes. Since this is less than 10 degrees, this would be considered an acceptable design.

The length of the rail is adjusted by 12'-6" rail section increments until the approach end of the end terminal (last post) is 12'-6" or more beyond the design runout path. Because the first 12'-6" of the end terminal is yielding, and redirection takes place beginning at the third post, this portion of the end terminal is not considered part of the length of need.

The opposite side guardrail for the inside of the horizontal curve is dimensioned off of the roadway centerline in accordance with the offset dimensions provided in the standard drawings, and longitudinal dimensions are adjusted to account for the horizontal curvature.

### III-13.11 W-Beam Guardrail End Terminal Installation Requirements

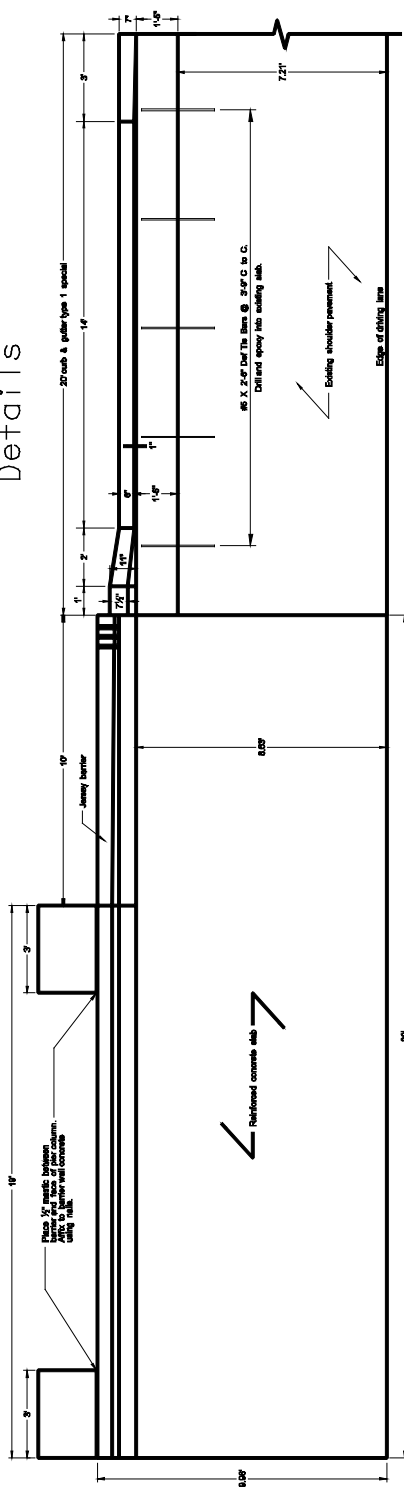
Four W-beam guardrail end terminals are used by NDDOT. These end terminals have varying site location and guardrail installation configuration requirements. The type or types of end terminals which may be installed at a given location shall be specified in the guardrail plans.

- A. ET-2000, as shown on Standard D-764-2B: The ET-2000 end terminal shall be installed on straight guardrail installations, or installations having a flare rate no greater than 25:1 relative to the approaching traffic. Where necessary, the ET-2000 may be installed straight, tangent to the approach guardrail (and parallel to the traveled way), however it is preferred, (and typical NDDOT practice) that this end terminal be tapered at 50:1 to allow clearance for snow removal equipment, and to reduce the likelihood of nuisance hits.
- B. Flared Energy Absorbing Terminal (FLEAT) as shown on Standard D-764-2C: The FLEAT end terminal shall be installed with either the 2'-6" or 4'-0 flare as shown on Standard D-764-2C, when it is installed on the end of a straight (parallel to traveled way) W-beam guardrail installation. When the FLEAT is installed to the end of a flared guardrail installation having standard flare rates of 10:1 to 16:1, the end terminal shall be installed with only the flare rate of the downstream guardrail.
- C. Sequential Kinking Terminal (SKT), as shown on Standard D-764-2D: The SKT end terminal shall be installed on straight guardrail installations, or installations having a flare rate no greater than 25:1 relative to the approaching traffic. Where necessary, the SKT may be installed straight, tangent to the approach guardrail (and parallel to the traveled way), however it is preferred, (and typical NDDOT practice) that this end terminal be tapered at 50:1 to allow clearance for snow removal equipment, and to reduce the likelihood of nuisance hits.
- D. Slotted Rail Terminal (SRT), as shown on Standard D-764-2H: The SRT end terminal shall be installed with the 4'-0 flare as shown on Standard D-764-2H, whether it is installed on the ends of straight W-beam guardrail or flared W-beam guardrail. The Slotted Rail Terminal shall not be installed at locations where the distance from the upstream end of the end terminal to the obstruction being shielded is less than 175 feet.

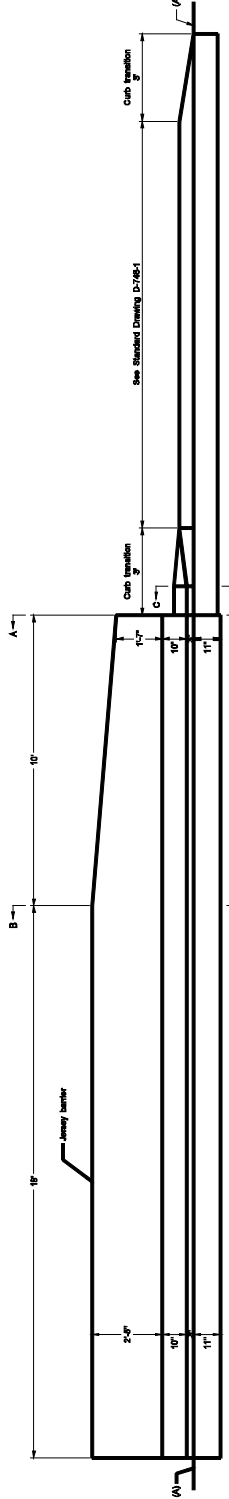


- Figure 1 Jersey Barrier at Outside Piers Details
- Figure 2 Jersey Barrier at Outside Piers – Reinforcing Details
- Figure 3 Jersey Barrier at Outside Piers – Bent Bar Details and Bar List
- Figure 4 Median Pier Transition Wall and Attenuation Device Layout
- Figure 5 Median Pier Transition Wall Details
- Figure 6 Median Pier Transition Wall Details – Reinforcing Steel Layout
- Figure 7 Median Pier Transition Wall – Bent Bar Details and Bar List
- Figure 8 Jersey Barrier and Attenuation Device Layout
- Figure 9 Jersey Barrier Details
- Figure 10 Jersey Barrier – Reinforcing Steel Layout
- Figure 11 Jersey Barrier Details – Bent Bar Details, Bar List
- Figure 12 Barrel Attenuation Device Details
- Figure 13 W-Beam Pier Protection End Treatment Details
- Figure 14 W-Beam Guardrail at Horizontal Curves Example

# Jersey Barrier At Outside Piers Details

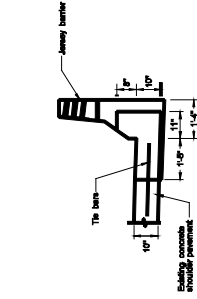


Plan View

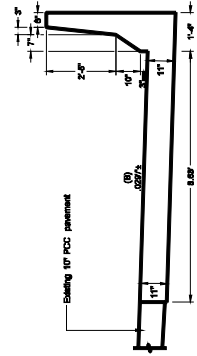


Elevation View  
Facing South

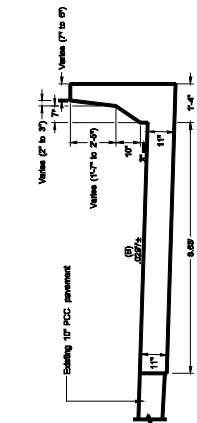
- (A) Finished surface
- (B) The cross slope of the side shall slope as near as possible. However, minor adjustment of the cross slope may be required to maintain drainage of the shoulder along the face of the barrier and curb.



Section C-C



Section B-B



Section A-A

FIGURE 1

Revised 6-1-07

Jersey Barrier At Outside Piers  
Reinforcing Details

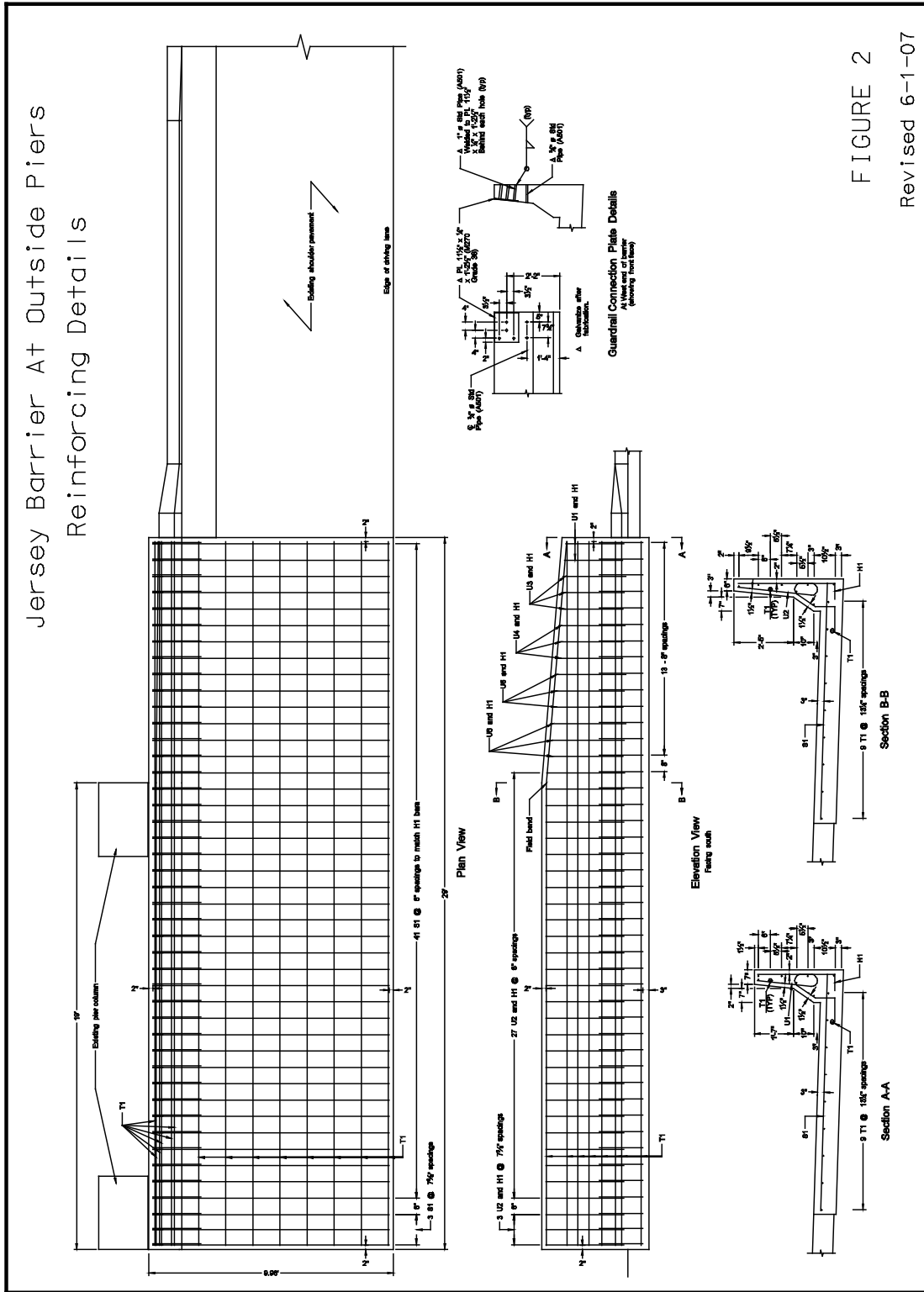
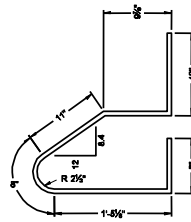
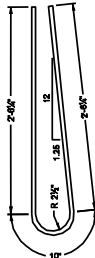
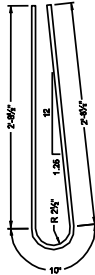
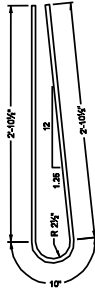
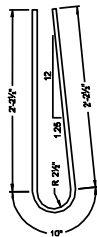
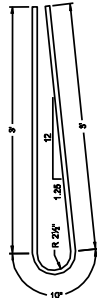
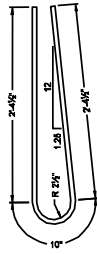


FIGURE 2

Revised 6-1-07

Jersey Barrier At Outside Piers  
Bent Bar Details and Bar List

BAR LIST - ONE BARRIER				
MARK	SIZE	NO.	LENGTH	SHAPE
H1	5	44	6'-6"	BENT
S1	5	44	9'-7 1/2"	STRAIGHT
T1	5	18	28'-8"	STRAIGHT
U1	5	2	5'-3"	BENT
U2	5	28	6'-10"	BENT
U3	5	3	8'-10 1/2"	BENT
U6	5	3	6'-2"	BENT
U8	5	3	6'-2"	BENT



BENT BAR DETAILS

Construction notes:

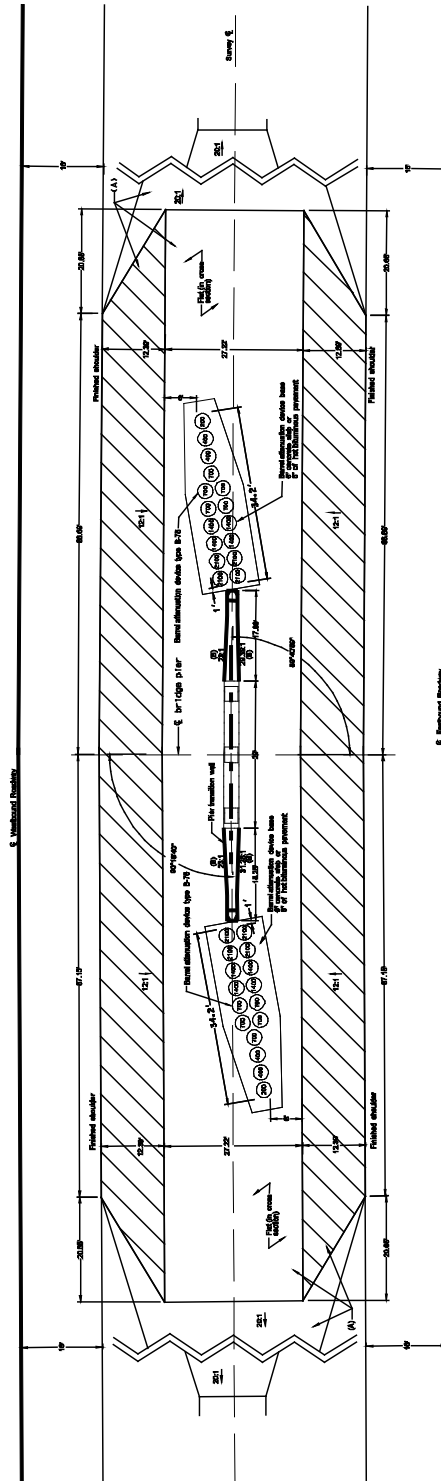
1. Barriers shall be constructed in accordance with Section 602.03 B.4 except that the top of the barrier shall be finished with a smooth finish. All faces of the barrier shall be finished with a smooth finish.
2. Each barrier section shall be bonded to the adjacent section. The barrier shall be installed and secured as shown in the drawings. The barrier shall be installed in the same manner as shown in the drawings. The barrier shall be installed in the same manner as shown in the drawings. The barrier shall be installed in the same manner as shown in the drawings.
3. Dimensions of bent bars are given in feet and inches. All dimensions shall be in the same units. All dimensions shall be in the same units. All dimensions shall be in the same units. All dimensions shall be in the same units.
4. Materials shall be as specified in the drawings. All materials shall be as specified in the drawings. All materials shall be as specified in the drawings. All materials shall be as specified in the drawings.
5. Surface finish shall be as specified in the drawings. All surface finish shall be as specified in the drawings. All surface finish shall be as specified in the drawings. All surface finish shall be as specified in the drawings.

FIGURE 3

Revised 6-1-07

### Median Pier Transition Wall And Attenuation Device Layout

Where median pier foundation consists of a vertical wall 42" or higher than finished median.



- (A) The substructure must extend to the foundation elevation indicated in the notes.
- (B) The foundation must be 42" or higher than finished median.
- (C) The foundation must be 42" or higher than finished median.

8. Retention Device

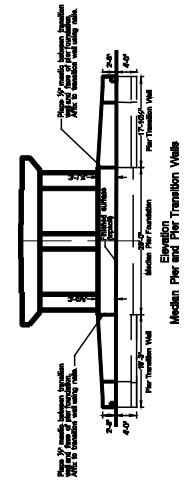
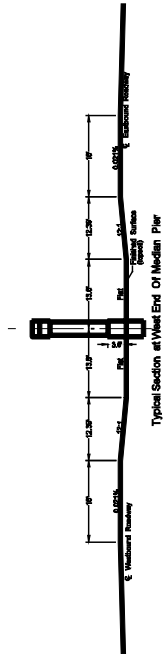


FIGURE 4  
Revised 6-1-07

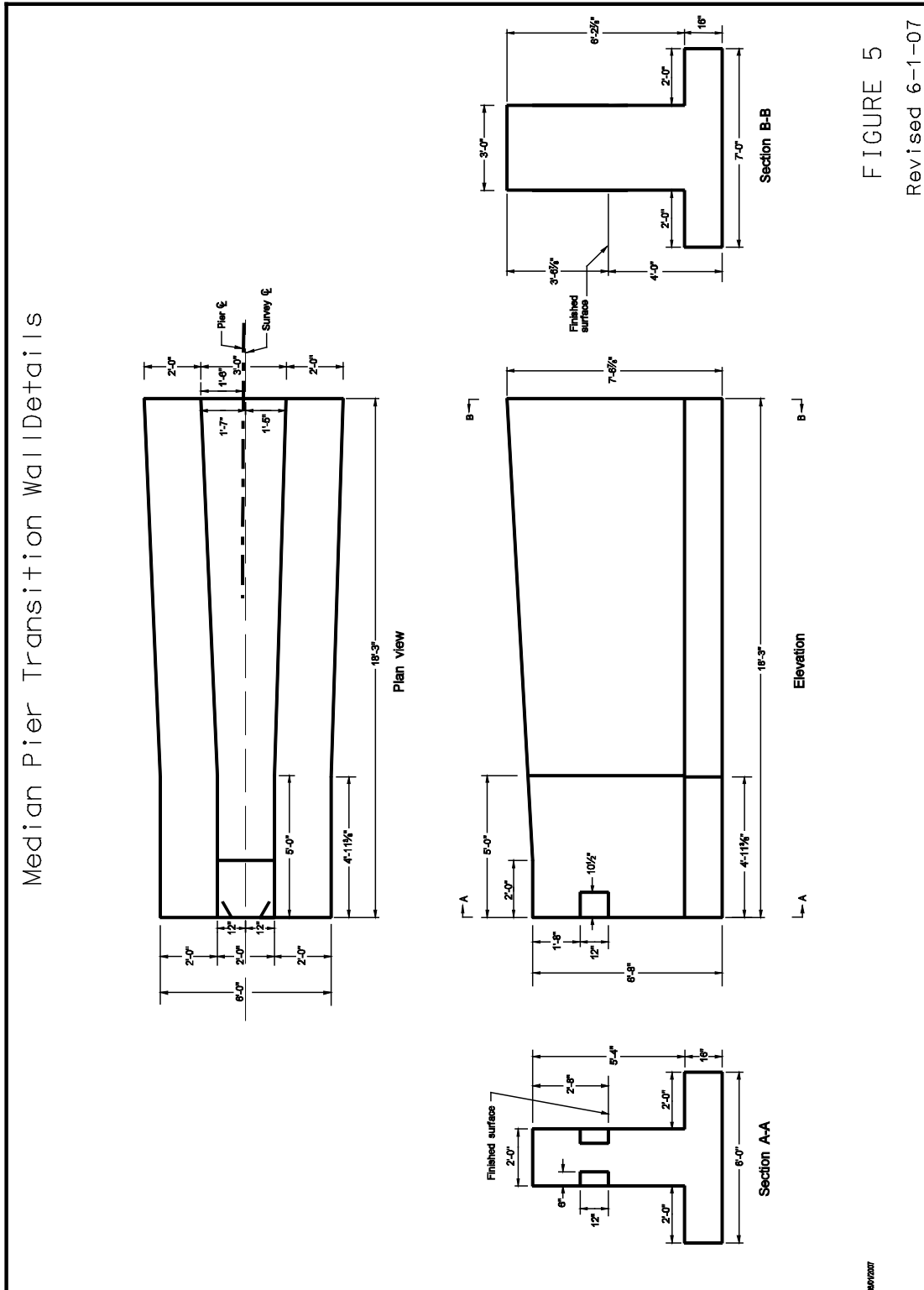
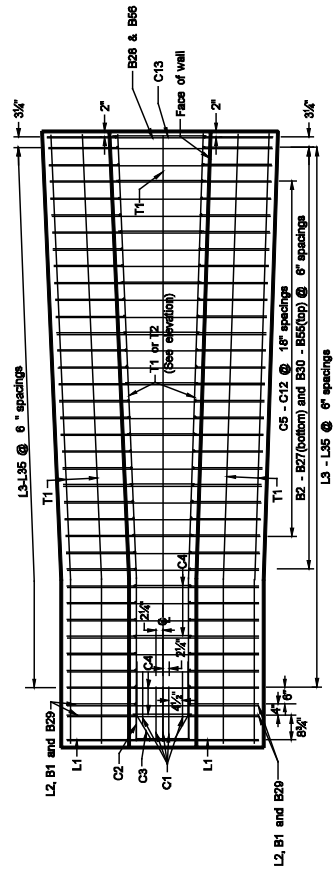


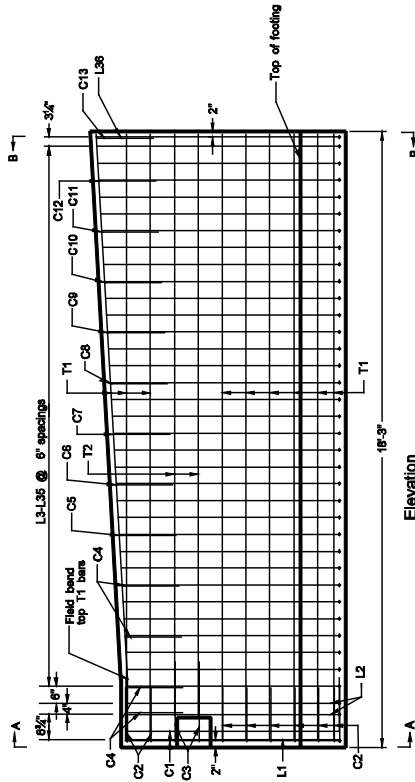
FIGURE 5  
Revised 6-1-07

SAVIMOR

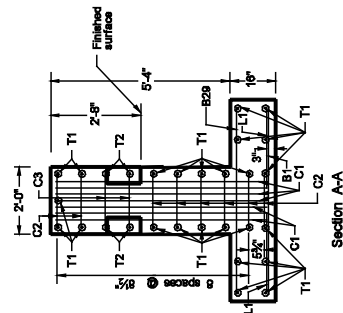
Median Pier Transition Wall Details  
Reinforcing Steel Layout



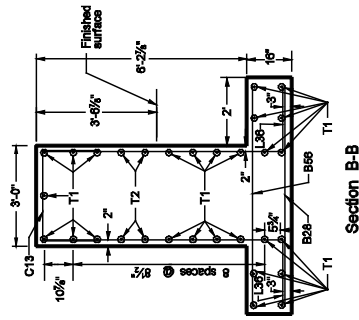
Plan view



Elevation



Section A-A



Section B-B

FIGURE 6

Revised 6-1-07

Median Pier Transition Wall  
Bent Bar Details and Bar List

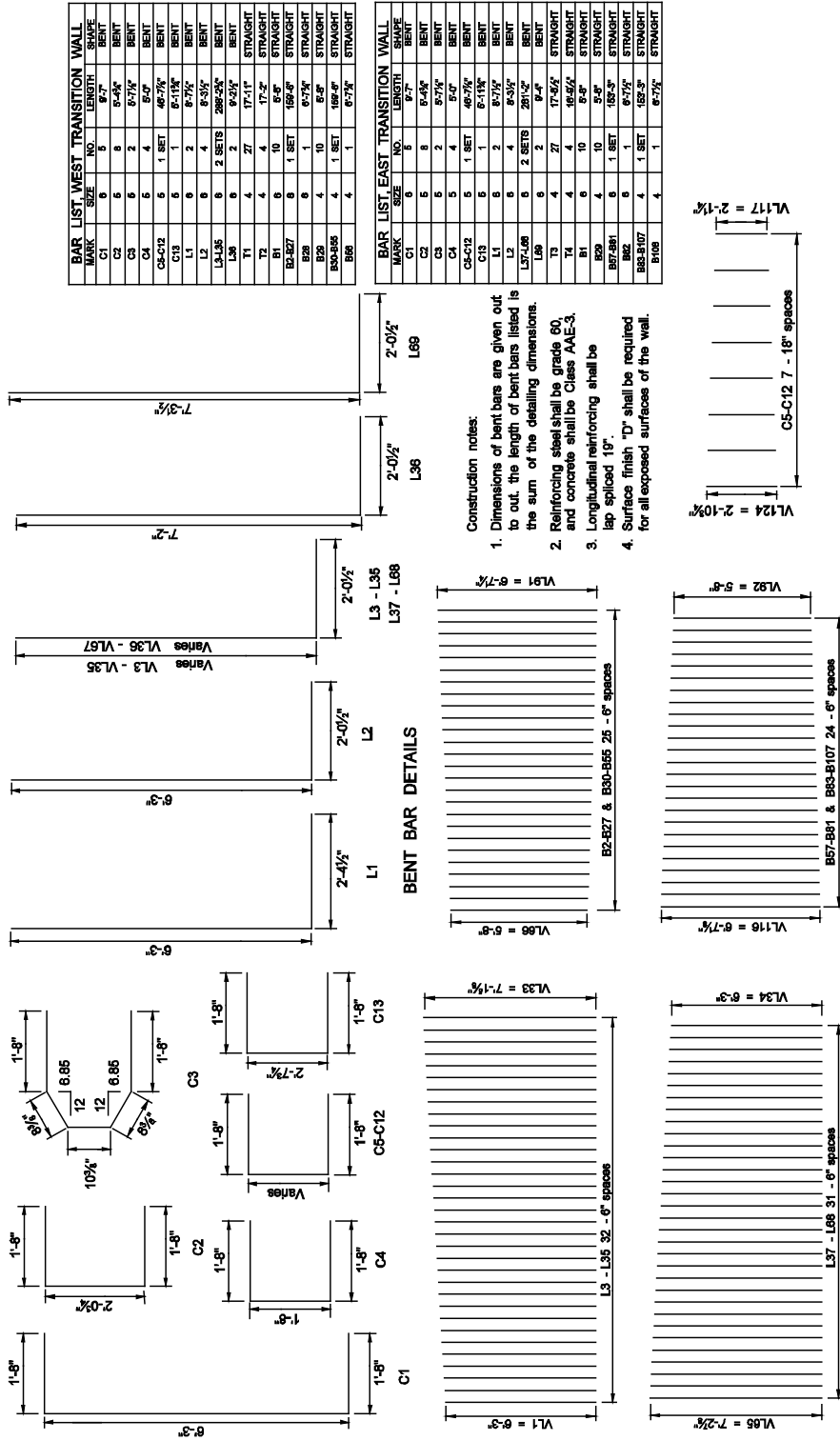
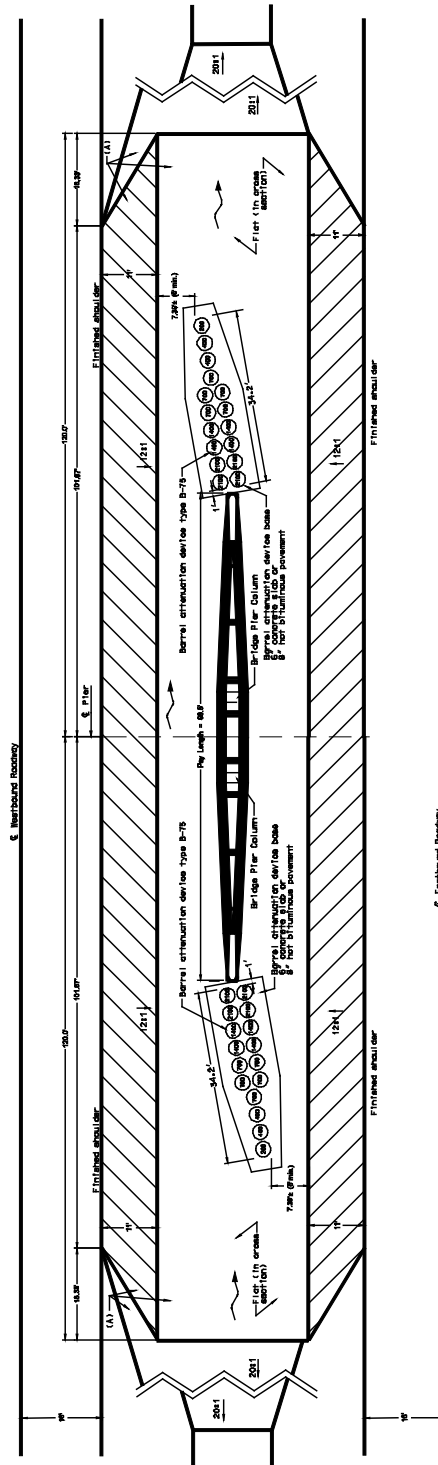


FIGURE 7  
Revised 6-1-07



Jersey Barrier And Attenuation Device Layout

Note: The barrel attenuation device shall be as shown on attached drawing B-702-1, except the reflective sheeting and baffle.  
The contractor will not be required to provide additional replacement module for this installation.  
The barrel attenuation device bases shall not be paid for. The bases shall be provided by the contractor for the item "Barrel Attenuation device type B-75".



(A) The embankment material required for this installation has been included in the quantities for the item Common excavation type - N.

FIGURE 8

Revised 6-1-07

Jersey Barrier Details

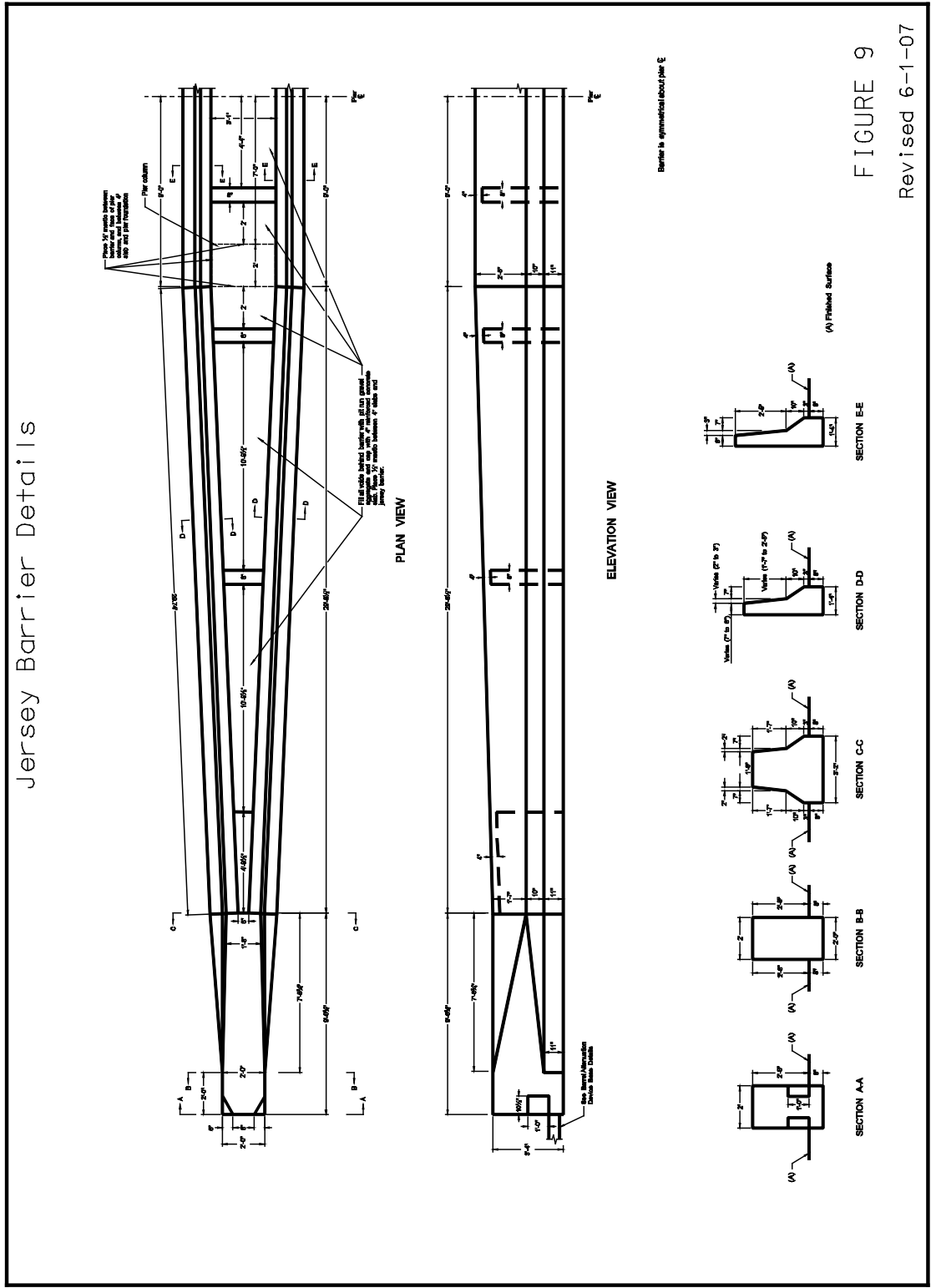
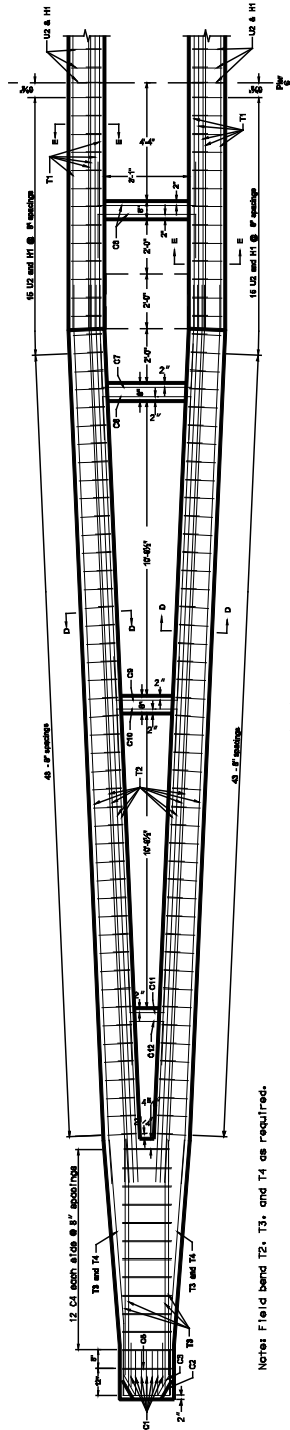
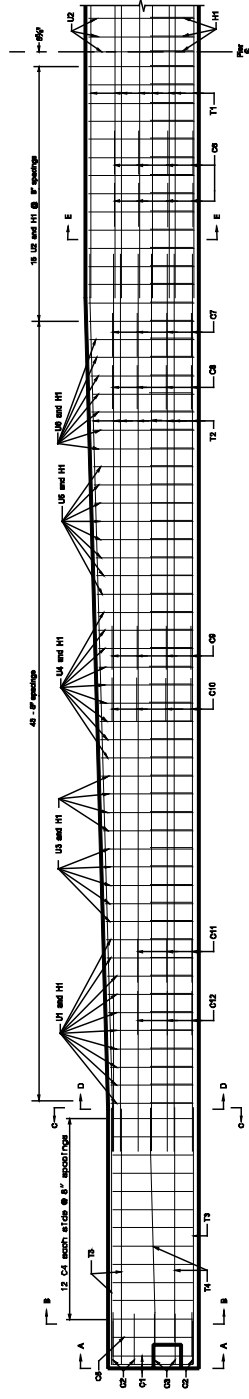


FIGURE 9  
Revised 6-1-07

Jersey Barrier Reinforcing Steel Layout



PLAN VIEW



ELEVATION VIEW

Note: Barrier layout is symmetrical about 3/4" E.

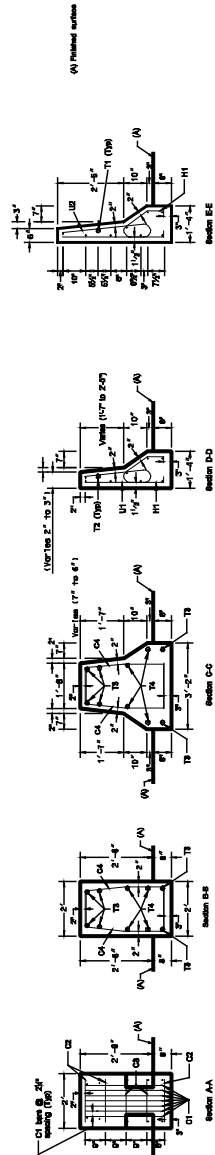
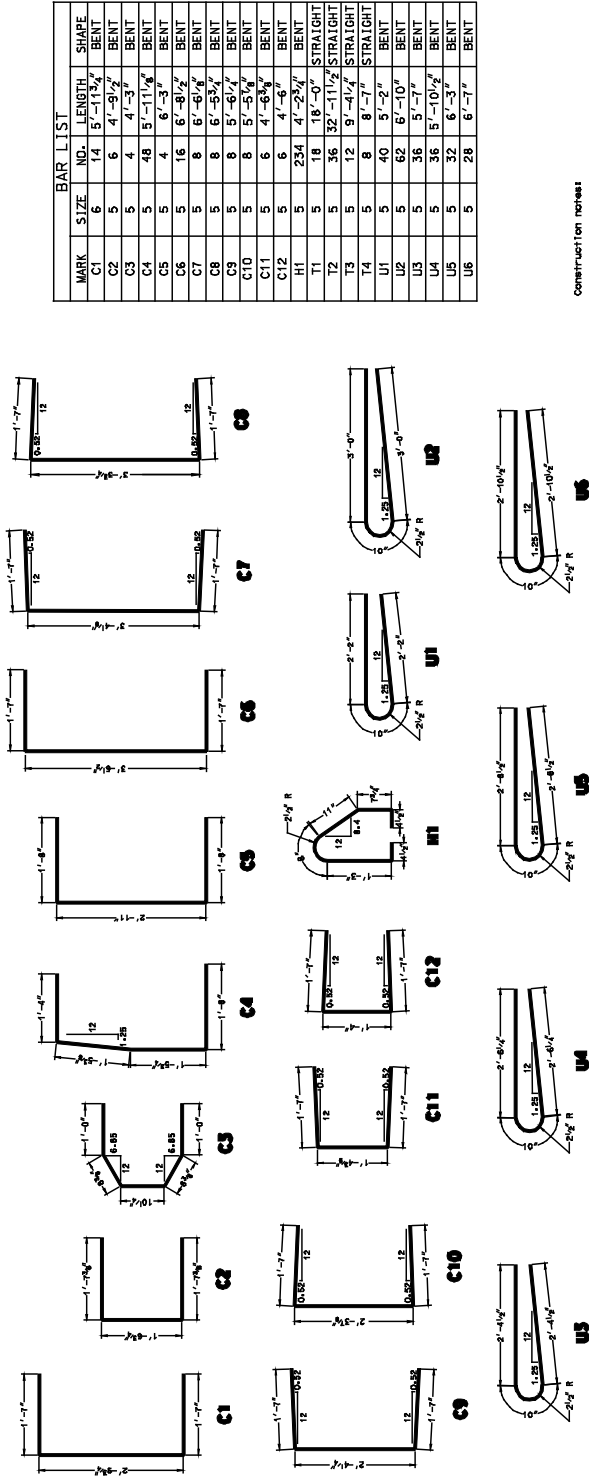


FIGURE 10

Revised 6-1-07

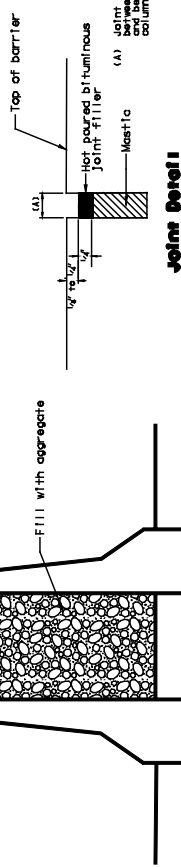
Jersey Barrier Details  
Bent Bar Details, Bar List



BENT BAR DETAILS

- CONSTRUCTION NOTES
1. Barriers shall be constructed with a minimum of 20% steel reinforcement. The steel shall be no less than #4 and shall be placed in the barrier at approximately 10-foot spacings.
  2. The top of barrier shall be finished to the top of the barrier and shall be finished to the top of the barrier and shall be finished to the top of the barrier.
  3. Reinforcing steel shall be grade 60, and concrete shall be class AEC-3.
  4. Concrete shall be finished to the top of the barrier and shall be finished to the top of the barrier.
  5. Concrete shall be finished to the top of the barrier and shall be finished to the top of the barrier.

See Joint Detail  
Concrete slab reinforced with WFL 608 - WFL 5 X WFL 5.  
Fill with aggregate

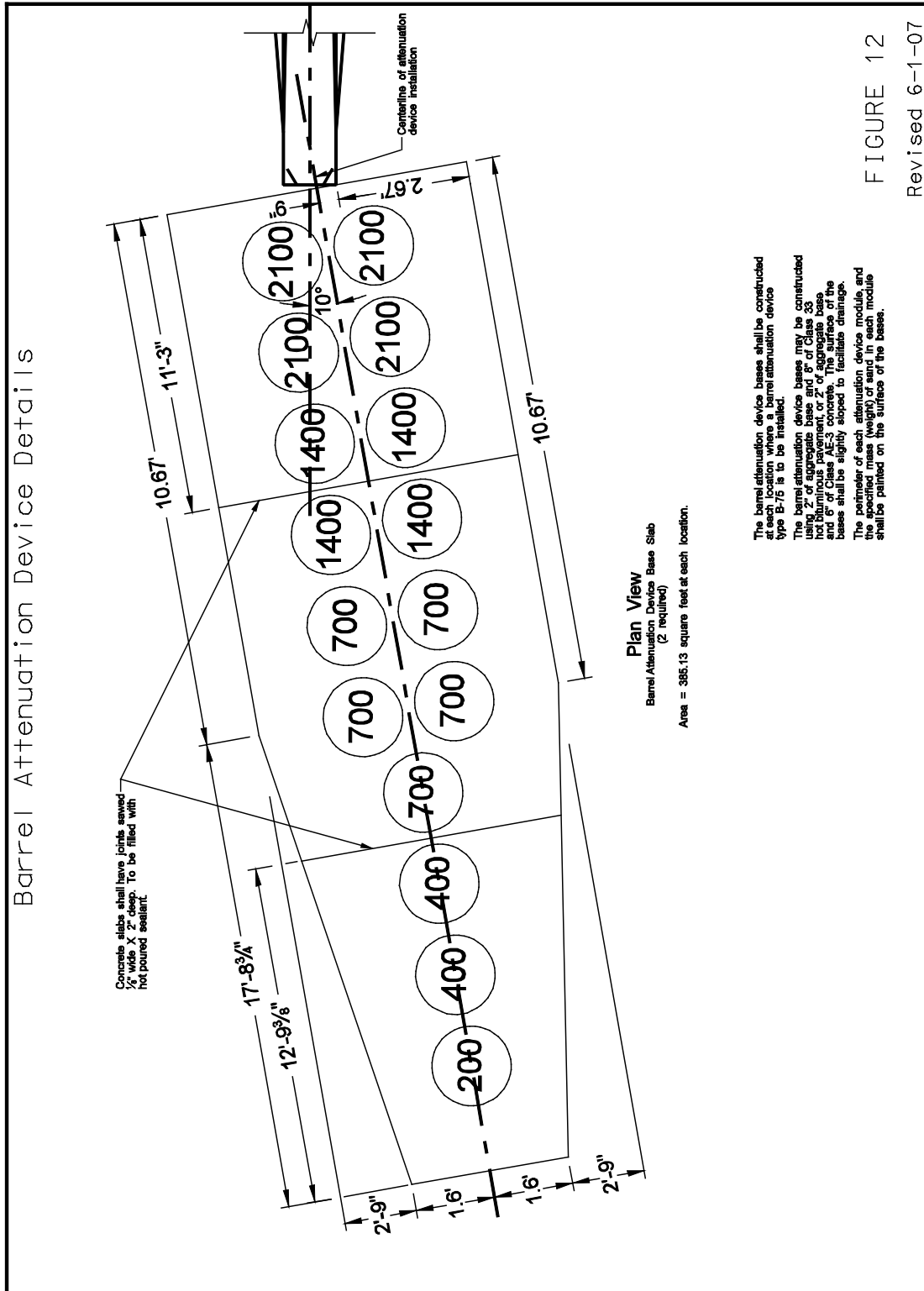


4" Slab and Aggregate Fill Detail

Joint Detail

Joint width shall be 1/2 inch between barrier and pier columns.

FIGURE 11  
Revised 6-1-07



The barrel attenuation device bases shall be constructed at each location where a barrel attenuation device type B-75 is to be installed.  
The barrel attenuation device bases may be constructed using 2" of aggregate base and 8" of Class 33 hot bituminous pavement, or 2" of aggregate base and 8" of Class A-E-3 concrete. The surface of the bases shall be slightly sloped to facilitate drainage.  
The perimeter of each attenuation device module, and the specified mass (weight) of each module shall be printed on the surface of the bases.

FIGURE 12

Revised 6-1-07

W-Beam Pier Protection End Treatment Details

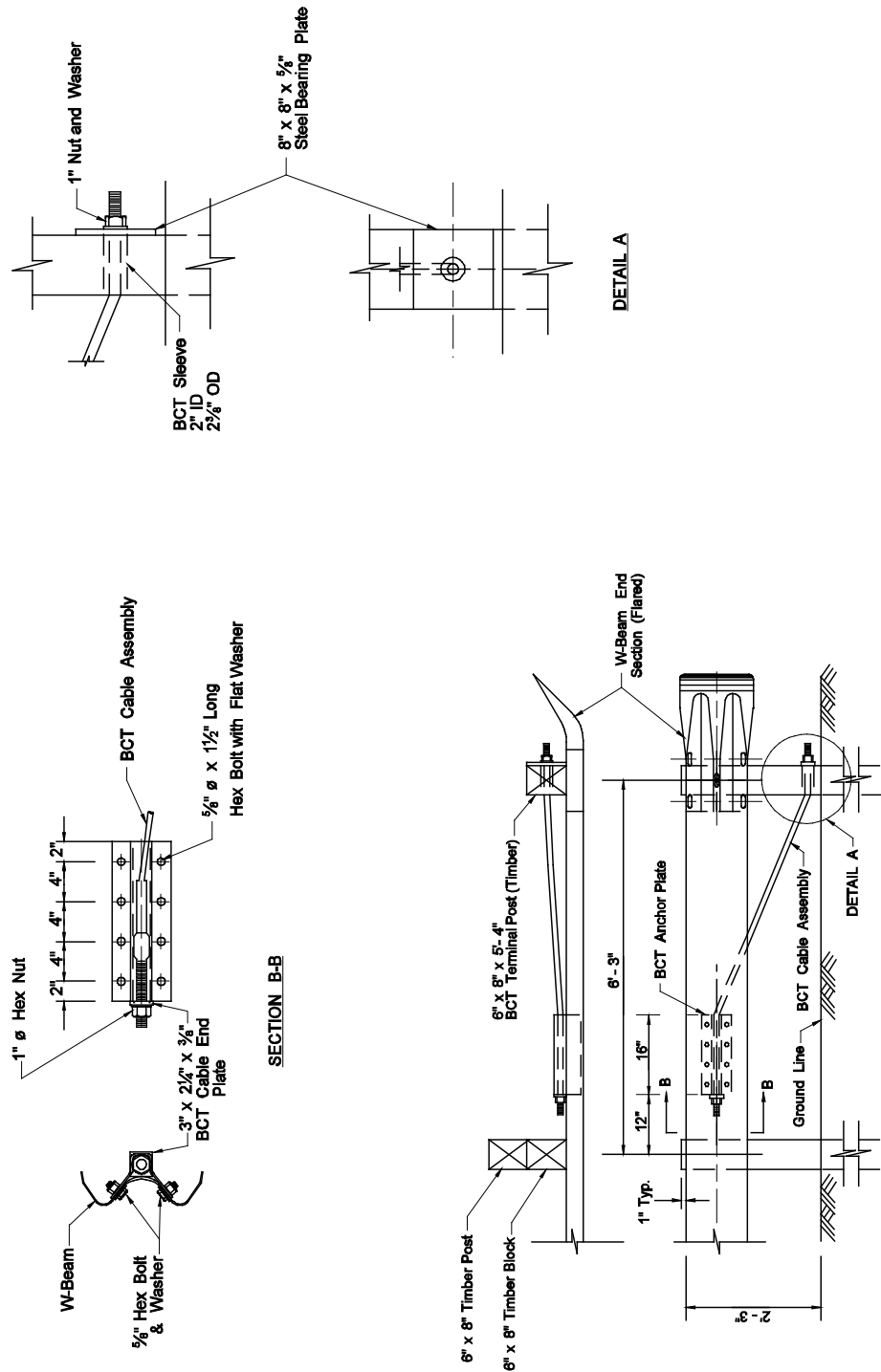
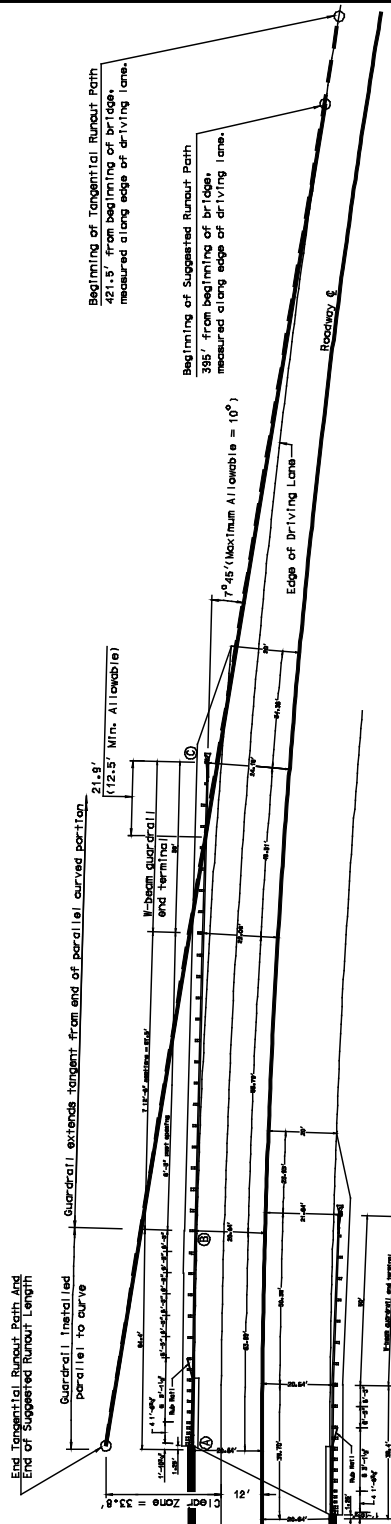


FIGURE 13  
Revised 6-1-07

W-Beam Pier Protection End Treatment Details

W-Beam Guardrail at Horizontal Curve Example



From ① to ② the W-beam guardrail is installed parallel to the horizontal curve.  
From ② to ③ the W-beam guardrail extends tangent from point ② to point ③.

**DESIGN EXAMPLE**  
**W-beam Guardrail Installation**  
**On the Outside of**  
**Horizontal Curve**

Design Data  
Design Speed = 70 MPH  
Forecast ADT = 1000  
Curve D = 2710' (R=444.42')  
Clear Zone = 33.6' (C=100 ft)  
Clear Zone Corrected for curve = 33.6'  
Suggested Runout Length = 395'

FIGURE 14  
Revised 6-1-07



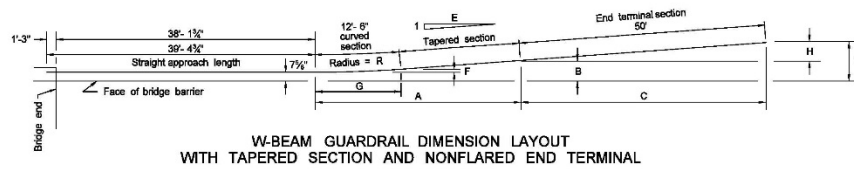
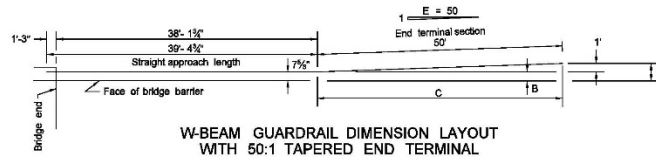
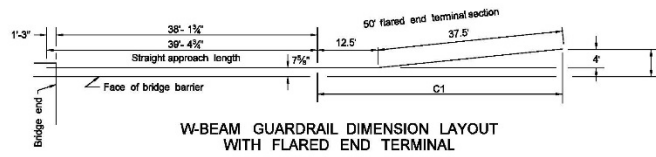






LENGTH OF NEED TABLE 50 MPH DESIGN SPEED																						
DESIGN TRAFFIC VOLUME	CLEAR ROADWAY WIDTH OF BRIDGE	STRAIGHT APPROACH LENGTH	APPROACH SIDE							OPPOSITE SIDE												
			A	B	C	D	C1	D1	E	A	B	C	D	C1	D1	E						
			FT	FT	FT	FT	FT	FT	FT	FT	FT	FT	FT	FT	FT	FT	FT					
UNDER 750 ADT	48	39.4	0.00	0.64	49.99	1.64	49.79	4.64	50	39.4	0.00	0.64	49.99	1.64	49.79	4.64	50	39.4				
	46	39.4	0.00	0.64	49.99	1.64	49.79	4.64	50	39.4	0.00	0.64	49.99	1.64	49.79	4.64	50	39.4				
	750 - 1500 ADT	44	39.4	0.00	0.64	49.99	1.64	49.79	4.64	50	39.4	0.00	0.64	49.99	1.64	49.79	4.64	50	39.4			
		42	39.4	0.00	0.64	49.99	1.64	49.79	4.64	50	39.4	0.00	0.64	49.99	1.64	49.79	4.64	50	39.4			
		1500 - 2000 ADT	40	39.4	0.00	0.64	49.99	1.64	49.79	4.64	50	39.4	0.00	0.64	49.99	1.64	49.79	4.64	50	39.4		
			38	39.4	0.00	0.64	49.99	1.64	49.79	4.64	50	39.4	0.00	0.64	49.99	1.64	49.79	4.64	50	39.4		
			2000 - 6000 ADT	36	39.4	0.00	0.64	49.99	1.64	49.79	4.64	50	39.4	0.00	0.64	49.99	1.64	49.79	4.64	50	39.4	
				34	39.4	0.00	0.64	49.99	1.64	49.79	4.64	50	39.4	0.00	0.64	49.99	1.64	49.79	4.64	50	39.4	
				OVER 6000 ADT	32	39.4	0.00	0.64	49.99	1.64	49.79	4.64	50	39.4	0.00	0.64	49.99	1.64	49.79	4.64	50	39.4
					30	39.4	0.00	0.64	49.99	1.64	49.79	4.64	50	39.4	0.00	0.64	49.99	1.64	49.79	4.64	50	39.4
					28	39.4	0.00	0.64	49.99	1.64	49.79	4.64	50	39.4	0.00	0.64	49.99	1.64	49.79	4.64	50	39.4
					26	39.4	0.00	0.64	49.99	1.64	49.79	4.64	50	39.4	0.00	0.64	49.99	1.64	49.79	4.64	50	39.4
					24	39.4	0.00	0.64	49.99	1.64	49.79	4.64	50	39.4	0.00	0.64	49.99	1.64	49.79	4.64	50	39.4
					22	39.4	0.00	0.64	49.99	1.64	49.79	4.64	50	39.4	0.00	0.64	49.99	1.64	49.79	4.64	50	39.4
					20	39.4	0.00	0.64	49.99	1.64	49.79	4.64	50	39.4	0.00	0.64	49.99	1.64	49.79	4.64	50	39.4
					18	39.4	0.00	0.64	49.99	1.64	49.79	4.64	50	39.4	0.00	0.64	49.99	1.64	49.79	4.64	50	39.4
					16	39.4	0.00	0.64	49.99	1.64	49.79	4.64	50	39.4	0.00	0.64	49.99	1.64	49.79	4.64	50	39.4
					14	39.4	0.00	0.64	49.99	1.64	49.79	4.64	50	39.4	0.00	0.64	49.99	1.64	49.79	4.64	50	39.4
					12	39.4	0.00	0.64	49.99	1.64	49.79	4.64	50	39.4	0.00	0.64	49.99	1.64	49.79	4.64	50	39.4
					10	39.4	0.00	0.64	49.99	1.64	49.79	4.64	50	39.4	0.00	0.64	49.99	1.64	49.79	4.64	50	39.4
					8	39.4	0.00	0.64	49.99	1.64	49.79	4.64	50	39.4	0.00	0.64	49.99	1.64	49.79	4.64	50	39.4
					6	39.4	0.00	0.64	49.99	1.64	49.79	4.64	50	39.4	0.00	0.64	49.99	1.64	49.79	4.64	50	39.4
					4	39.4	0.00	0.64	49.99	1.64	49.79	4.64	50	39.4	0.00	0.64	49.99	1.64	49.79	4.64	50	39.4
					2	39.4	0.00	0.64	49.99	1.64	49.79	4.64	50	39.4	0.00	0.64	49.99	1.64	49.79	4.64	50	39.4

GUARDRAIL AT BRIDGE ENDS  
50 MPH DESIGN SPEED



DESIGN SPEED	F	G	H	R
	50	0.57	12.48	4.53

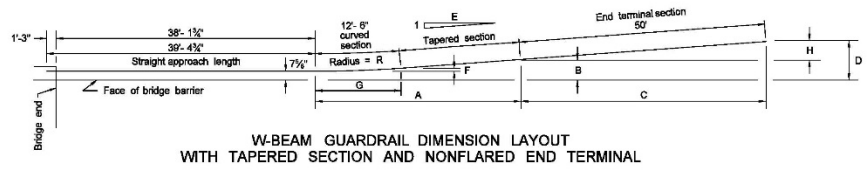
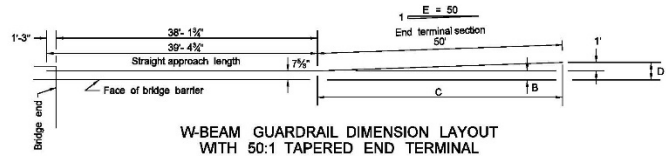
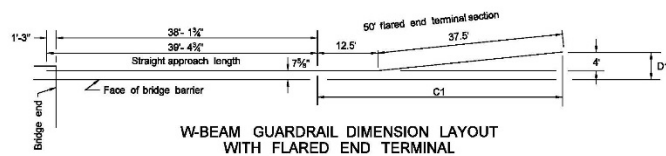
NOTES:  
On divided highways use distance from roadway centerline to bridge rail #2 and use this as clear roadway width of the bridge to determine guardrail length.  
The contractor shall use wood posts for W-beam guardrail.

- ① Does not include end terminal section
  - ② The 39'-4 1/2' straight approach length is for use with the transition shown on Standard Drawing D-764-3.
  - ③ Dimensions "B", "D" and "D1" include the 7 1/2" (0.64') offset from the lower face of jersey barrier to the rear face of the W-beam guardrail.
- For the transition shown on Standard Drawing D-764-3A, revise straight approach length to 45.85'.  
For installations using the transition shown on Standard Drawing D-764-3A, subtract 0.64' from the dimensions "B", "D" and "D1", to obtain offset from face of guardrail connection plate.



LENGTH OF NEED TABLE 60 MPH DESIGN SPEED																		
DESIGN SPEED ADT	CLEAR ROADWAY WIDTH OF BRIDGE ②	APPROACH SIDE							OPPOSITE SIDE									
		A		B		C		E	A		B		C		E			
		FT	FT	FT	FT	FT	FT		FT	FT	FT	FT	FT	FT		FT		
UNDER 750 ADT	48	39.4	12.49	1.08	49.87	4.64		14	51.9	0.00	0.64	49.99	1.64	49.79	4.64	50	39.4	
		46	39.4	12.49	1.08	49.87	4.64		14	51.9	0.00	0.64	49.99	1.64	49.79	4.64	50	39.4
		44	39.4	12.49	1.08	49.87	4.64		14	51.9	0.00	0.64	49.99	1.64	49.79	4.64	50	39.4
		42	39.4	24.96	1.97	49.87	5.53		14	64.4	0.00	0.64	49.99	1.64	49.79	4.64	50	39.4
		40	39.4	24.96	1.97	49.87	5.53		14	64.4	0.00	0.64	49.99	1.64	49.79	4.64	50	39.4
		38	39.4	37.43	2.96	49.87	6.42		14	76.9	0.00	0.64	49.99	1.64	49.79	4.64	50	39.4
		36	39.4	49.89	3.75	49.87	7.32		14	89.4	0.00	0.64	49.99	1.64	49.79	4.64	50	39.4
		34	39.4	49.89	3.75	49.87	7.32		14	89.4	0.00	0.64	49.99	1.64	49.79	4.64	50	39.4
		32	39.4	62.36	4.64	49.87	8.21		14	101.9	0.00	0.64	49.99	1.64	49.79	4.64	50	39.4
		30	39.4	74.83	5.53	49.87	9.10		14	114.4	0.00	0.64	49.99	1.64	49.79	4.64	50	39.4
		28	39.4	74.83	5.53	49.87	9.10		14	114.4	0.00	0.64	49.99	1.64	49.79	4.64	50	39.4
		26	39.4	87.30	6.42	49.87	9.99		14	126.9	0.00	0.64	49.99	1.64	49.79	4.64	50	39.4
750 - 1500 ADT	24	39.4	99.77	7.32	49.87	10.88		14	139.4	12.49	1.08	49.87	4.64		14	51.9		
		48	39.4	37.43	2.96	49.87	6.42		14	76.9	0.00	0.64	49.99	1.64	49.79	4.64	50	39.4
		46	39.4	37.43	2.96	49.87	6.42		14	76.9	0.00	0.64	49.99	1.64	49.79	4.64	50	39.4
		44	39.4	49.89	3.75	49.87	7.32		14	89.4	0.00	0.64	49.99	1.64	49.79	4.64	50	39.4
		42	39.4	49.89	3.75	49.87	7.32		14	89.4	0.00	0.64	49.99	1.64	49.79	4.64	50	39.4
		40	39.4	62.36	4.64	49.87	8.21		14	101.9	0.00	0.64	49.99	1.64	49.79	4.64	50	39.4
		38	39.4	74.83	5.53	49.87	9.10		14	114.4	0.00	0.64	49.99	1.64	49.79	4.64	50	39.4
		36	39.4	74.83	5.53	49.87	9.10		14	114.4	0.00	0.64	49.99	1.64	49.79	4.64	50	39.4
		34	39.4	87.30	6.42	49.87	9.99		14	126.9	12.49	1.08	49.87	4.64		14	51.9	
		32	39.4	87.30	6.42	49.87	9.99		14	126.9	12.49	1.08	49.87	4.64		14	51.9	
		30	39.4	99.77	7.32	49.87	10.88		14	139.4	12.49	1.08	49.87	4.64		14	51.9	
		28	39.4	99.77	7.32	49.87	10.88		14	139.4	24.96	1.97	49.87	5.53		14	64.4	
1500 - 2000 ADT	26	39.4	112.24	8.21	49.87	11.77		14	151.9	24.96	1.97	49.87	5.53		14	64.4		
		24	39.4	124.70	9.10	49.87	12.66		14	164.4	37.43	2.96	49.87	6.42		14	76.9	
		48	39.4	62.36	4.64	49.87	8.21		14	101.9	0.00	0.64	49.99	1.64	49.79	4.64	50	39.4
		46	39.4	62.36	4.64	49.87	8.21		14	101.9	0.00	0.64	49.99	1.64	49.79	4.64	50	39.4
		44	39.4	74.83	5.53	49.87	9.10		14	114.4	12.49	1.08	49.87	4.64		14	51.9	
		42	39.4	74.83	5.53	49.87	9.10		14	114.4	12.49	1.08	49.87	4.64		14	51.9	
		40	39.4	87.30	6.42	49.87	9.99		14	126.9	12.49	1.08	49.87	4.64		14	51.9	
		38	39.4	87.30	6.42	49.87	9.99		14	126.9	12.49	1.08	49.87	4.64		14	51.9	
		36	39.4	99.77	7.32	49.87	10.88		14	139.4	24.96	1.97	49.87	5.53		14	64.4	
		34	39.4	99.77	7.32	49.87	10.88		14	139.4	24.96	1.97	49.87	5.53		14	64.4	
		32	39.4	112.24	8.21	49.87	11.77		14	151.9	37.43	2.96	49.87	6.42		14	76.9	
		30	39.4	112.24	8.21	49.87	11.77		14	151.9	37.43	2.96	49.87	6.42		14	76.9	
2000 - 4000 ADT	28	39.4	124.70	9.10	49.87	12.66		14	164.4	49.89	3.75	49.87	7.32		14	89.4		
		26	39.4	124.70	9.10	49.87	12.66		14	164.4	49.89	3.75	49.87	7.32		14	89.4	
		48	39.4	137.17	9.99	49.87	13.55		14	176.9	62.36	4.64	49.87	8.21		14	101.9	
		46	39.4	149.64	10.88	49.87	14.44		14	189.4	84.83	5.53	49.87	9.10		14	114.4	
		44	39.4	149.64	10.88	49.87	14.44		14	189.4	84.83	5.53	49.87	9.10		14	114.4	
		42	39.4	162.11	11.77	49.87	15.33		14	201.9	107.30	6.42	49.87	9.99		14	126.9	
		40	39.4	162.11	11.77	49.87	15.33		14	201.9	107.30	6.42	49.87	9.99		14	126.9	
		38	39.4	174.58	12.66	49.87	16.22		14	214.4	129.77	7.32	49.87	10.88		14	139.4	
		36	39.4	174.58	12.66	49.87	16.22		14	214.4	129.77	7.32	49.87	10.88		14	139.4	
		34	39.4	187.05	13.55	49.87	17.11		14	226.9	152.24	8.21	49.87	11.77		14	151.9	
		32	39.4	187.05	13.55	49.87	17.11		14	226.9	152.24	8.21	49.87	11.77		14	151.9	
		30	39.4	199.52	14.44	49.87	18.00		14	239.4	174.71	9.10	49.87	12.66		14	164.4	

**GUARDRAIL AT BRIDGE ENDS  
60 MPH DESIGN SPEED**



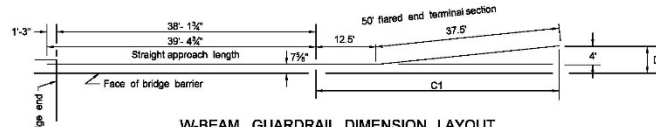
DESIGN SPEED	F	G	H	R
	FT	FT	FT	FT
60	0.45	12.49	3.56	175.30

**NOTES:**  
On divided highways use distance from roadway centerline to bridge rail/2 and use this as clear roadway width of the bridge to determine guardrail length.  
The contractor shall use wood posts for W-beam guardrail.

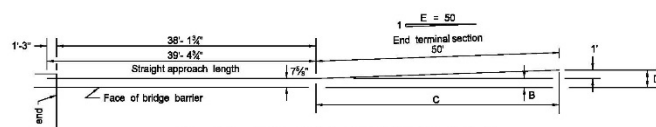
- ① Does not include end terminal section
- ② The 39'-4 1/2" straight approach length is for use with the transition shown on Standard Drawing D-764-3.
- For the transition shown on Standard Drawing D-764-3A, revise straight approach length to 45.65.
- ③ Dimensions "B", "D" and "D1" include the 7 1/2" (0.84') offset from the lower face of jersey barrier to the rear face of the W-beam guardrail.
- For installations using the transition shown on Standard Drawing D-764-3A, subtract 0.64' from the dimensions "B", "D" and "D1", to obtain offset from face of guardrail connection plate.

DESIGN TRAFFIC VOLUME	LENGTH OF NEED TABLE 65 MPH DESIGN SPEED																	
	CLEAR ROADWAY WIDTH OF BRIDGE	STRAIGHT APPROACH LENGTH	APPROACH SIDE							TOTAL W-BEAM LENGTH	OPPOSITE SIDE							TOTAL W-BEAM LENGTH
			A	B	C	D	C1	D1	E		A	B	C	D	C1	D1	E	
UNDER 750 ADT	48	39.4	12.49	1.05	49.89	4.38			15	51.9	0.00	0.64	49.99	1.64	49.79	4.64	50	39.4
	46	39.4	24.96	1.88	49.89	5.21			15	64.4	0.00	0.64	49.99	1.64	49.79	4.64	50	39.4
	44	39.4	24.96	1.88	49.89	5.21			15	64.4	0.00	0.64	49.99	1.64	49.79	4.64	50	39.4
	42	39.4	37.43	2.71	49.89	6.04			15	76.9	0.00	0.64	49.99	1.64	49.79	4.64	50	39.4
	40	39.4	49.91	3.55	49.89	6.87			15	89.4	0.00	0.64	49.99	1.64	49.79	4.64	50	39.4
750 - 1500 ADT	38	39.4	49.91	3.55	49.89	6.87			15	89.4	0.00	0.64	49.99	1.64	49.79	4.64	50	39.4
	36	39.4	62.38	4.38	49.89	7.70			15	101.9	0.00	0.64	49.99	1.64	49.79	4.64	50	39.4
	34	39.4	74.85	5.21	49.89	8.53			15	114.4	0.00	0.64	49.99	1.64	49.79	4.64	50	39.4
	32	39.4	74.85	5.21	49.89	8.53			15	114.4	0.00	0.64	49.99	1.64	49.79	4.64	50	39.4
	30	39.4	87.32	6.04	49.89	9.37			15	126.9	0.00	0.64	49.99	1.64	49.79	4.64	50	39.4
1500 - 2000 ADT	28	39.4	99.80	6.87	49.89	10.20			15	139.4	12.49	1.05	49.89	4.38				51.9
	26	39.4	99.80	6.87	49.89	10.20			15	139.4	12.49	1.05	49.89	4.38				51.9
	24	39.4	112.27	7.70	49.89	11.03			15	151.9	12.49	1.05	49.89	4.38				51.9
	48	39.4	49.91	3.55	49.89	6.87			15	89.4	0.00	0.64	49.99	1.64	49.79	4.64	50	39.4
	46	39.4	62.38	4.38	49.89	7.70			15	101.9	0.00	0.64	49.99	1.64	49.79	4.64	50	39.4
2000 - 6000 ADT	44	39.4	62.38	4.38	49.89	7.70			15	101.9	0.00	0.64	49.99	1.64	49.79	4.64	50	39.4
	42	39.4	74.85	5.21	49.89	8.53			15	114.4	0.00	0.64	49.99	1.64	49.79	4.64	50	39.4
	40	39.4	74.85	5.21	49.89	8.53			15	114.4	0.00	0.64	49.99	1.64	49.79	4.64	50	39.4
	38	39.4	87.32	6.04	49.89	9.37			15	126.9	12.49	1.05	49.89	4.38				51.9
	36	39.4	99.80	6.87	49.89	10.20			15	139.4	12.49	1.05	49.89	4.38				51.9
OVER 6000 ADT	34	39.4	99.80	6.87	49.89	10.20			15	139.4	12.49	1.05	49.89	4.38				51.9
	32	39.4	112.27	7.70	49.89	11.03			15	151.9	24.96	1.88	49.89	5.21				64.4
	30	39.4	112.27	7.70	49.89	11.03			15	151.9	24.96	1.88	49.89	5.21				64.4
	28	39.4	124.74	8.53	49.89	11.86			15	164.4	37.43	2.71	49.89	6.04				76.9
	26	39.4	124.74	8.53	49.89	11.86			15	164.4	37.43	2.71	49.89	6.04				76.9
COVER 6000 ADT	24	39.4	137.21	9.37	49.89	12.69			15	176.9	49.91	3.55	49.89	6.87				89.4
	48	39.4	74.85	5.21	49.89	8.53			15	114.4	12.49	1.05	49.89	4.38				51.9
	46	39.4	87.32	6.04	49.89	9.37			15	126.9	12.49	1.05	49.89	4.38				51.9
	44	39.4	87.32	6.04	49.89	9.37			15	126.9	12.49	1.05	49.89	4.38				51.9
	42	39.4	99.80	6.87	49.89	10.20			15	139.4	12.49	1.05	49.89	4.38				51.9
	40	39.4	99.80	6.87	49.89	10.20			15	139.4	24.96	1.88	49.89	5.21				64.4
	38	39.4	112.27	7.70	49.89	11.03			15	151.9	24.96	1.88	49.89	5.21				64.4
	36	39.4	124.74	8.53	49.89	11.86			15	164.4	37.43	2.71	49.89	6.04				76.9
	34	39.4	137.21	9.37	49.89	12.69			15	176.9	49.91	3.55	49.89	6.87				89.4
	32	39.4	149.69	10.20	49.89	13.52			15	189.4	62.38	4.38	49.89	7.70				101.9
	30	39.4	149.69	10.20	49.89	13.52			15	189.4	62.38	4.38	49.89	7.70				101.9
	28	39.4	162.16	11.03	49.89	14.36			15	201.9	74.85	5.21	49.89	8.53				114.4
	26	39.4	162.16	11.03	49.89	14.36			15	201.9	74.85	5.21	49.89	8.53				114.4
	24	39.4	174.63	11.86	49.89	15.19			15	214.4	87.32	6.04	49.89	9.37				126.9
	48	39.4	99.80	6.87	49.89	10.20			15	139.4	12.49	1.05	49.89	4.38				51.9
	46	39.4	112.27	7.70	49.89	11.03			15	151.9	24.96	1.88	49.89	5.21				64.4
	44	39.4	112.27	7.70	49.89	11.03			15	151.9	37.43	2.71	49.89	6.04				76.9
	42	39.4	124.74	8.53	49.89	11.86			15	164.4	37.43	2.71	49.89	6.04				76.9
	40	39.4	124.74	8.53	49.89	11.86			15	164.4	49.91	3.55	49.89	6.87				89.4
	38	39.4	137.21	9.37	49.89	12.69			15	176.9	49.91	3.55	49.89	6.87				89.4
	36	39.4	149.69	10.20	49.89	13.52			15	189.4	62.38	4.38	49.89	7.70				101.9
	34	39.4	149.69	10.20	49.89	13.52			15	189.4	62.38	4.38	49.89	7.70				101.9
	32	39.4	162.16	11.03	49.89	14.36			15	201.9	74.85	5.21	49.89	8.53				114.4
	30	39.4	162.16	11.03	49.89	14.36			15	201.9	74.85	5.21	49.89	8.53				114.4
	28	39.4	174.63	11.86	49.89	15.19			15	214.4	87.32	6.04	49.89	9.37				126.9
	26	39.4	174.63	11.86	49.89	15.19			15	214.4	99.80	6.87	49.89	10.20				139.4
	24	39.4	187.10	12.69	49.89	16.02			15	226.9	99.80	6.87	49.89	10.20				139.4

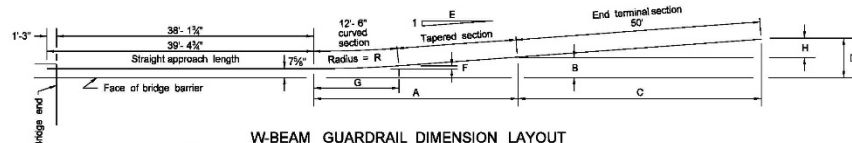
GUARDRAIL AT BRIDGE ENDS  
65 MPH DESIGN SPEED



W-BEAM GUARDRAIL DIMENSION LAYOUT WITH FLARED END TERMINAL



W-BEAM GUARDRAIL DIMENSION LAYOUT WITH 50:1 TAPERED END TERMINAL



W-BEAM GUARDRAIL DIMENSION LAYOUT WITH TAPERED SECTION AND UNFLARED END TERMINAL

DESIGN SPEED	F	G	H	R
65	0.42	12.49	3.33	187.78

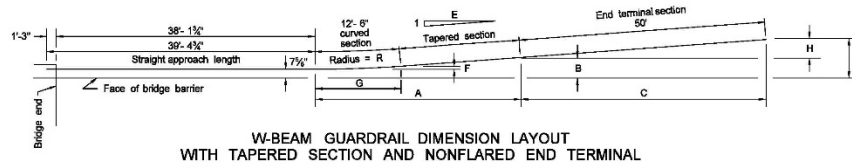
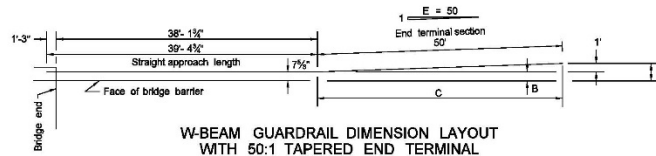
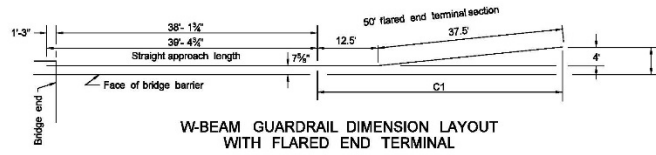
NOTES:

- On divided highways use distance from roadway centerline to bridge rail x 2 and use this as clear roadway width of the bridge to determine guardrail length.
- The contractor shall use wood posts for W-beam guardrail.

- ① Does not include end terminal section
- ② The 39.4' straight approach length is for use with the transition shown on Standard Drawing D-784-3.
- For the transition shown on Standard Drawing D-784-3A, revise straight approach length to 45.60'
- ③ Dimensions "B", "D" and "D1" include the 7 1/2" (0.64') offset from the lower face of jersey barrier to the rear face of the W-beam guardrail.
- For installations using the transition shown on Standard Drawing D-784-3A, subtract 0.64' from the dimensions "C", "D" and "D1", to obtain offset from face of guardrail connection plate.

		LENGTH OF NEED TABLE 70 MPH DESIGN SPEED																																								
DESIGN TRAFFIC VOLUME	CLEAR ROADWAY WIDTH OF BRIDGE	APPROACH SIDE								OPPOSITE SIDE																																
		②		③		③		③		③		③		③		③																										
		FT	FT	FT	FT	FT	FT	FT	FT	FT	FT	FT	FT	FT	FT	FT	FT																									
	STRAIGHT APPROACH LENGTH	TOTAL W-BEAM LENGTH	①	A	B	C	D	C1	D1	E	TOTAL W-BEAM LENGTH	①	A	B	C	D	C1	D1	E	TOTAL W-BEAM LENGTH																						
																					UNDEVELOPED																					
																					700 - 1500 ADT																					
1500 - 2000 ADT																																										
2000 - 4000 ADT																																										
OVER 4000 ADT																																										

GUARDRAIL AT BRIDGE ENDS  
70 MPH DESIGN SPEED



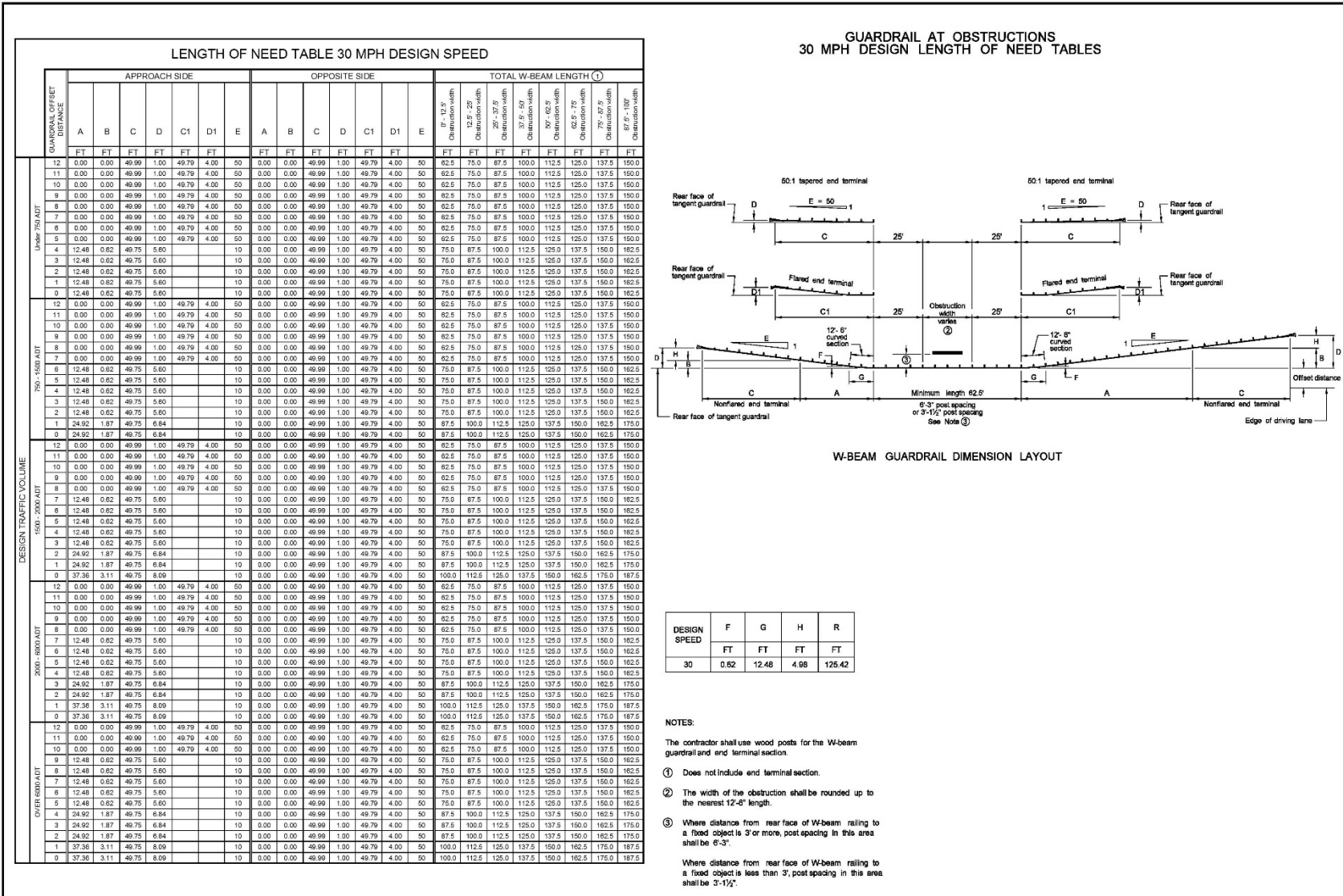
DESIGN SPEED	F	G	H	R
	70	0.42	12.49	3.33

NOTES:  
On divided highways use distance from roadway centerline to bridge rail/2 and use this as clear roadway width of the bridge to determine guardrail length.  
The contractor shall use wood posts for W-beam guardrail.

- ① Does not include end terminal section
- ② The 38' straight approach length is for use with the transition shown on Standard Drawing D-704-3.  
For the transition shown on Standard Drawing D-704-3A, revise straight approach length to 45.65.
- ③ Dimensions "B", "D" and "D1" include the 7 1/2" (0.84') offset from the lower face of jersey barrier to the rear face of the W-beam guardrail.  
For installations using the transition shown on Standard Drawing D-704-3A, subtract 0.64' from the dimensions "B", "D" and "D1", to obtain offset from face of guardrail connection plate.



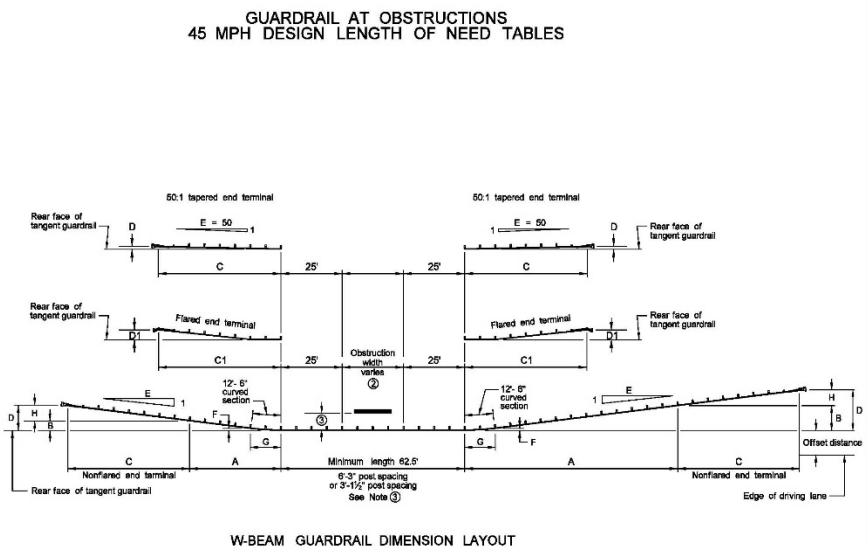






**LENGTH OF NEED TABLE 45 MPH DESIGN SPEED**

GUARDRAIL OFFSET DISTANCE	APPROACH SIDE							OPPOSITE SIDE							TOTAL W-BEAM LENGTH (1)									
	A	B	C	D	C1	D1	E	A	B	C	D	C1	D1	E	45'-15" Obstruction width	52'-0" Obstruction width	59'-0" Obstruction width	62'-5"-79" Obstruction width	70'-0"-75" Obstruction width	87'-0"-100' Obstruction width				
	FT	FT	FT	FT	FT	FT	FT	FT	FT	FT	FT	FT	FT	FT	FT	FT	FT	FT	FT	FT				
Under 750 ADT	12	0.00	0.00	49.99	1.00	49.79	4.00	50	0.00	0.00	49.99	1.00	49.79	4.00	50	62.5	75.0	87.5	100.0	112.5	125.0	137.5	150.0	
	11	0.00	0.00	49.99	1.00	49.79	4.00	50	0.00	0.00	49.99	1.00	49.79	4.00	50	62.5	75.0	87.5	100.0	112.5	125.0	137.5	150.0	
	10	0.00	0.00	49.99	1.00	49.79	4.00	50	0.00	0.00	49.99	1.00	49.79	4.00	50	62.5	75.0	87.5	100.0	112.5	125.0	137.5	150.0	
	9	0.00	0.00	49.99	1.00	49.79	4.00	50	0.00	0.00	49.99	1.00	49.79	4.00	50	62.5	75.0	87.5	100.0	112.5	125.0	137.5	150.0	
	8	0.00	0.00	49.99	1.00	49.79	4.00	50	0.00	0.00	49.99	1.00	49.79	4.00	50	62.5	75.0	87.5	100.0	112.5	125.0	137.5	150.0	
	7	12.48	0.62	49.75	5.60			10	0.00	0.00	49.99	1.00	49.79	4.00	50	75.0	87.5	100.0	112.5	125.0	137.5	150.0	162.5	
	6	12.48	0.62	49.75	5.60			10	0.00	0.00	49.99	1.00	49.79	4.00	50	75.0	87.5	100.0	112.5	125.0	137.5	150.0	162.5	
	5	12.48	0.62	49.75	5.60			10	0.00	0.00	49.99	1.00	49.79	4.00	50	75.0	87.5	100.0	112.5	125.0	137.5	150.0	162.5	
	4	12.48	0.62	49.75	5.60			10	0.00	0.00	49.99	1.00	49.79	4.00	50	75.0	87.5	100.0	112.5	125.0	137.5	150.0	162.5	
	3	24.92	1.87	49.75	6.84			10	0.00	0.00	49.99	1.00	49.79	4.00	50	87.5	100.0	112.5	125.0	137.5	150.0	162.5	175.0	
750 - 1500 ADT	12	0.00	0.00	49.99	1.00	49.79	4.00	50	0.00	0.00	49.99	1.00	49.79	4.00	50	62.5	75.0	87.5	100.0	112.5	125.0	137.5	150.0	
	11	0.00	0.00	49.99	1.00	49.79	4.00	50	0.00	0.00	49.99	1.00	49.79	4.00	50	62.5	75.0	87.5	100.0	112.5	125.0	137.5	150.0	
	10	12.48	0.62	49.75	5.60			10	0.00	0.00	49.99	1.00	49.79	4.00	50	75.0	87.5	100.0	112.5	125.0	137.5	150.0	162.5	
	9	12.48	0.62	49.75	5.60			10	0.00	0.00	49.99	1.00	49.79	4.00	50	75.0	87.5	100.0	112.5	125.0	137.5	150.0	162.5	
	8	12.48	0.62	49.75	5.60			10	0.00	0.00	49.99	1.00	49.79	4.00	50	75.0	87.5	100.0	112.5	125.0	137.5	150.0	162.5	
	7	12.48	0.62	49.75	5.60			10	0.00	0.00	49.99	1.00	49.79	4.00	50	75.0	87.5	100.0	112.5	125.0	137.5	150.0	162.5	
	6	24.92	1.87	49.75	6.84			10	0.00	0.00	49.99	1.00	49.79	4.00	50	87.5	100.0	112.5	125.0	137.5	150.0	162.5	175.0	
	5	24.92	1.87	49.75	6.84			10	0.00	0.00	49.99	1.00	49.79	4.00	50	87.5	100.0	112.5	125.0	137.5	150.0	162.5	175.0	
	4	24.92	1.87	49.75	6.84			10	0.00	0.00	49.99	1.00	49.79	4.00	50	87.5	100.0	112.5	125.0	137.5	150.0	162.5	175.0	
	3	37.36	3.11	49.75	8.09			10	0.00	0.00	49.99	1.00	49.79	4.00	50	100.0	112.5	125.0	137.5	150.0	162.5	175.0	187.5	
DESIGN TRAFFIC VOLUME	1500 - 2000 ADT	12	0.00	0.00	49.99	1.00	49.79	4.00	50	0.00	0.00	49.99	1.00	49.79	4.00	50	62.5	75.0	87.5	100.0	112.5	125.0	137.5	150.0
	11	0.00	0.00	49.99	1.00	49.79	4.00	50	0.00	0.00	49.99	1.00	49.79	4.00	50	62.5	75.0	87.5	100.0	112.5	125.0	137.5	150.0	
	10	12.48	0.62	49.75	5.60			10	0.00	0.00	49.99	1.00	49.79	4.00	50	75.0	87.5	100.0	112.5	125.0	137.5	150.0	162.5	
	9	12.48	0.62	49.75	5.60			10	0.00	0.00	49.99	1.00	49.79	4.00	50	75.0	87.5	100.0	112.5	125.0	137.5	150.0	162.5	
	8	12.48	0.62	49.75	5.60			10	0.00	0.00	49.99	1.00	49.79	4.00	50	75.0	87.5	100.0	112.5	125.0	137.5	150.0	162.5	
	7	24.92	1.87	49.75	6.84			10	0.00	0.00	49.99	1.00	49.79	4.00	50	87.5	100.0	112.5	125.0	137.5	150.0	162.5	175.0	
	6	24.92	1.87	49.75	6.84			10	0.00	0.00	49.99	1.00	49.79	4.00	50	87.5	100.0	112.5	125.0	137.5	150.0	162.5	175.0	
	5	37.36	3.11	49.75	8.09			10	0.00	0.00	49.99	1.00	49.79	4.00	50	100.0	112.5	125.0	137.5	150.0	162.5	175.0	187.5	
	4	37.36	3.11	49.75	8.09			10	0.00	0.00	49.99	1.00	49.79	4.00	50	100.0	112.5	125.0	137.5	150.0	162.5	175.0	187.5	
	3	49.79	4.35	49.75	9.33			10	0.00	0.00	49.99	1.00	49.79	4.00	50	112.5	125.0	137.5	150.0	162.5	175.0	187.5	200.0	
OVER 8000 ADT	12	12.48	0.62	49.75	5.60			10	0.00	0.00	49.99	1.00	49.79	4.00	50	75.0	87.5	100.0	112.5	125.0	137.5	150.0	162.5	
	11	12.48	0.62	49.75	5.60			10	0.00	0.00	49.99	1.00	49.79	4.00	50	75.0	87.5	100.0	112.5	125.0	137.5	150.0	162.5	
	10	12.48	0.62	49.75	5.60			10	0.00	0.00	49.99	1.00	49.79	4.00	50	75.0	87.5	100.0	112.5	125.0	137.5	150.0	162.5	
	9	12.48	0.62	49.75	5.60			10	0.00	0.00	49.99	1.00	49.79	4.00	50	75.0	87.5	100.0	112.5	125.0	137.5	150.0	162.5	
	8	24.92	1.87	49.75	6.84			10	0.00	0.00	49.99	1.00	49.79	4.00	50	87.5	100.0	112.5	125.0	137.5	150.0	162.5	175.0	
	7	24.92	1.87	49.75	6.84			10	0.00	0.00	49.99	1.00	49.79	4.00	50	87.5	100.0	112.5	125.0	137.5	150.0	162.5	175.0	
	6	24.92	1.87	49.75	6.84			10	0.00	0.00	49.99	1.00	49.79	4.00	50	87.5	100.0	112.5	125.0	137.5	150.0	162.5	175.0	
	5	37.36	3.11	49.75	8.09			10	0.00	0.00	49.99	1.00	49.79	4.00	50	100.0	112.5	125.0	137.5	150.0	162.5	175.0	187.5	
	4	37.36	3.11	49.75	8.09			10	0.00	0.00	49.99	1.00	49.79	4.00	50	100.0	112.5	125.0	137.5	150.0	162.5	175.0	187.5	
	3	49.79	4.35	49.75	9.33			10	0.00	0.00	49.99	1.00	49.79	4.00	50	112.5	125.0	137.5	150.0	162.5	175.0	187.5	200.0	



**W-BEAM GUARDRAIL DIMENSION LAYOUT**

DESIGN SPEED	F	G	H	R
	FT	FT	FT	FT
45	0.82	12.48	4.98	126.42

- NOTES:**
- The contractor shall use wood posts for the W-beam guardrail and end terminal section.
  - Does not include end terminal section.
  - The width of the obstruction shall be rounded up to the nearest 12'-6" length.
  - Where distance from rear face of W-beam railing to a fixed object is 3' or more, post spacing in this area shall be 6'-3".
  - Where distance from rear face of W-beam railing to a fixed object is less than 3', post spacing in this area shall be 3'-11 1/2".

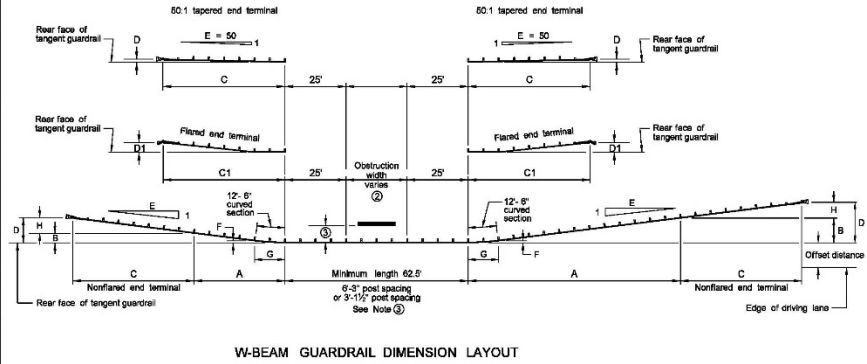




**LENGTH OF NEED TABLE 60 MPH DESIGN SPEED**

DESIGN TRAFFIC VOLUME	APPROACH SIDE							OPPOSITE SIDE							TOTAL W-BEAM LENGTH (1)									
	GUARDRAIL OFFSET DISTANCE	A	B	C	D	C1	D1	A	B	C	D	C1	D1	0'-30" Obstruction width	1'-0" - 20" Obstruction width	20'-27'9" Obstruction width	37'-5" Obstruction width	50'-62.5" Obstruction width	62.5'-79' Obstruction width	79'-97.5" Obstruction width	97.5'-100' Obstruction width			
		FT	FT	FT	FT	FT	FT	FT	FT	FT	FT	FT	FT	FT	FT	FT	FT	FT	FT	FT	FT	FT		
UNDER 750 ADT	12	12.49	0.45	49.87	4.01			14	0.00	0.00	49.99	1.00	49.79	4.00	50	75.0	87.5	100.0	112.5	125.0	137.5	150.0	162.5	175.0
	11	12.49	0.45	49.87	4.01			14	0.00	0.00	49.99	1.00	49.79	4.00	50	75.0	87.5	100.0	112.5	125.0	137.5	150.0	162.5	175.0
	10	24.96	1.34	49.87	4.00			14	0.00	0.00	49.99	1.00	49.79	4.00	50	87.5	100.0	112.5	125.0	137.5	150.0	162.5	175.0	187.5
	9	37.43	2.23	49.87	5.79			14	0.00	0.00	49.99	1.00	49.79	4.00	50	100.0	112.5	125.0	137.5	150.0	162.5	175.0	187.5	200.0
	8	37.43	2.23	49.87	5.79			14	0.00	0.00	49.99	1.00	49.79	4.00	50	100.0	112.5	125.0	137.5	150.0	162.5	175.0	187.5	200.0
750-1500 ADT	12	49.89	3.12	49.87	6.68			14	0.00	0.00	49.99	1.00	49.79	4.00	50	112.5	125.0	137.5	150.0	162.5	175.0	187.5	200.0	212.5
	11	49.89	3.12	49.87	6.68			14	0.00	0.00	49.99	1.00	49.79	4.00	50	125.0	137.5	150.0	162.5	175.0	187.5	200.0	212.5	225.0
	10	62.36	4.01	49.87	7.57			14	0.00	0.00	49.99	1.00	49.79	4.00	50	125.0	137.5	150.0	162.5	175.0	187.5	200.0	212.5	225.0
	9	62.36	4.01	49.87	7.57			14	0.00	0.00	49.99	1.00	49.79	4.00	50	137.5	150.0	162.5	175.0	187.5	200.0	212.5	225.0	237.5
	8	74.83	4.90	49.87	8.46			14	0.00	0.00	49.99	1.00	49.79	4.00	50	137.5	150.0	162.5	175.0	187.5	200.0	212.5	225.0	237.5
1500-2000 ADT	12	124.70	8.46	49.87	12.02			14	12.49	0.45	49.87	4.01			14	162.5	175.0	187.5	200.0	212.5	225.0	237.5	250.0	262.5
	11	124.70	8.46	49.87	12.02			14	12.49	0.45	49.87	4.01			14	175.0	187.5	200.0	212.5	225.0	237.5	250.0	262.5	275.0
	10	124.70	8.46	49.87	12.02			14	24.96	1.34	49.87	4.90			14	200.0	212.5	225.0	237.5	250.0	262.5	275.0	287.5	300.0
	9	124.70	8.46	49.87	12.02			14	24.96	1.34	49.87	4.90			14	200.0	212.5	225.0	237.5	250.0	262.5	275.0	287.5	300.0
	8	124.70	8.46	49.87	12.02			14	37.43	2.23	49.87	5.79			14	225.0	237.5	250.0	262.5	275.0	287.5	300.0	312.5	325.0
2000-3000 ADT	12	149.84	10.24	49.87	13.80			14	49.89	3.12	49.87	6.68			14	237.5	250.0	262.5	275.0	287.5	300.0	312.5	325.0	337.5
	11	149.84	10.24	49.87	13.80			14	49.89	3.12	49.87	6.68			14	250.0	262.5	275.0	287.5	300.0	312.5	325.0	337.5	350.0
	10	149.84	10.24	49.87	13.80			14	62.36	4.01	49.87	7.57			14	262.5	275.0	287.5	300.0	312.5	325.0	337.5	350.0	362.5
	9	149.84	10.24	49.87	13.80			14	62.36	4.01	49.87	7.57			14	275.0	287.5	300.0	312.5	325.0	337.5	350.0	362.5	375.0
	8	149.84	10.24	49.87	13.80			14	74.83	4.90	49.87	8.46			14	287.5	300.0	312.5	325.0	337.5	350.0	362.5	375.0	387.5
OVER 3000 ADT	12	162.11	11.13	49.87	14.89			14	62.36	4.01	49.87	7.57			14	275.0	287.5	300.0	312.5	325.0	337.5	350.0	362.5	375.0
	11	162.11	11.13	49.87	14.89			14	74.83	4.90	49.87	8.46			14	300.0	312.5	325.0	337.5	350.0	362.5	375.0	387.5	400.0
	10	162.11	11.13	49.87	14.89			14	87.30	5.79	49.87	9.35			14	312.5	325.0	337.5	350.0	362.5	375.0	387.5	400.0	412.5
	9	162.11	11.13	49.87	14.89			14	87.30	5.79	49.87	9.35			14	325.0	337.5	350.0	362.5	375.0	387.5	400.0	412.5	425.0
	8	174.58	12.02	49.87	15.59			14	99.77	6.68	49.87	10.24			14	337.5	350.0	362.5	375.0	387.5	400.0	412.5	425.0	437.5

GUARDRAIL AT OBSTRUCTIONS  
60 MPH DESIGN LENGTH OF NEED TABLES



DESIGN SPEED	F	G	H	R
	FT	FT	FT	FT
60	0.45	12.49	3.56	175.30

**NOTES:**

The contractor shall use wood posts for the W-beam guardrail and end terminal section.

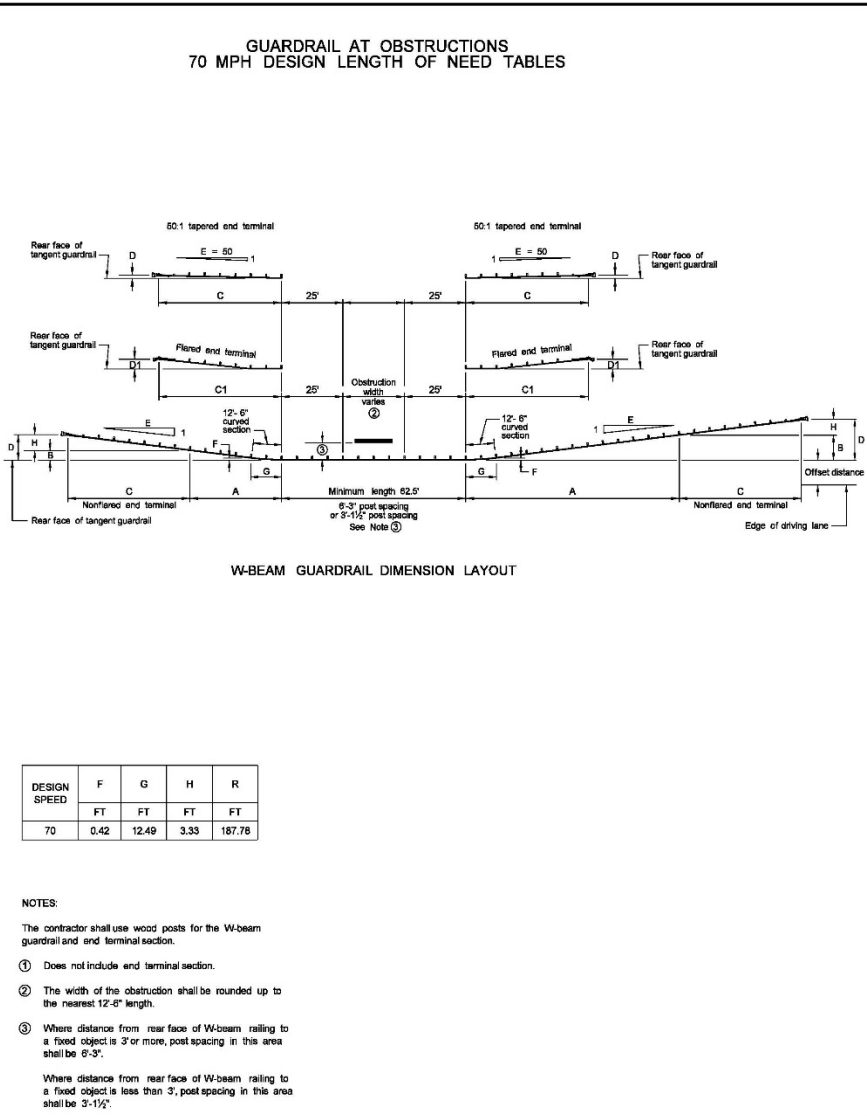
- 1 Does not include end terminal section.
- 2 The width of the obstruction shall be rounded up to the nearest 12'-6" length.
- 3 Where distance from rear face of W-beam railing to a fixed object is 3' or more, post spacing in this area shall be 6'-3".

Where distance from rear face of W-beam railing to a fixed object is less than 3', post spacing in this area shall be 5'-1/2".





GUARDRAIL OFFSET DISTANCE		LENGTH OF NEED TABLE 70 MPH DESIGN SPEED																				
		APPROACH SIDE							OPPOSITE SIDE							TOTAL W-BEAM LENGTH						
		A	B	C	D	C1	D1	E	A	B	C	D	C1	D1	E	6'-15' Obstruction width	15'-30' Obstruction width	30'-45' Obstruction width	45'-75' Obstruction width	75'-100' Obstruction width		
12	24.96	1.25	49.89	4.57			15	0.00	0.00	49.99	1.00	49.79	4.00	50	87.5	100.0	112.5	125.0	137.5	150.0	162.5	175.0



DESIGN SPEED	F	G	H	R
	70	0.42	12.49	3.33

- NOTES:
- The contractor shall use wood posts for the W-beam guardrail and terminal section.
  - ① Does not include end terminal section.
  - ② The width of the obstruction shall be rounded up to the nearest 12'-0" length.
  - ③ Where distance from rear face of W-beam railing to a fixed object is 3' or more, post spacing in this area shall be 6'-3".
- Where distance from rear face of W-beam railing to a fixed object is less than 3', post spacing in this area shall be 3'-11".





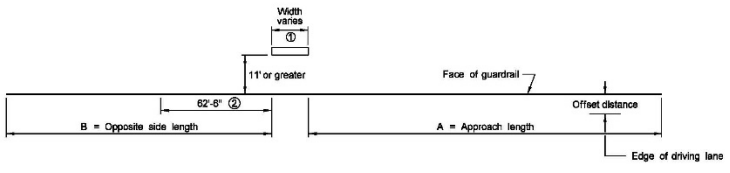




**LENGTH OF NEED TABLE 50 MPH DESIGN SPEED**

DESIGN TRAFFIC VOLUME	THRU-ROADWAY	THRU-ROADWAY	TWO WAY ROADWAYS																		DIVIDED HIGHWAY																			
			TOTAL THREE CABLE LENGTH (1)																		TOTAL THREE CABLE LENGTH (1)																			
			A									B									A									B										
			FT	FT	FT	FT	FT	FT	FT	FT	FT	FT	FT	FT	FT	FT	FT	FT	FT	FT	FT	FT	FT	FT	FT	FT	FT	FT	FT	FT	FT	FT	FT	FT	FT	FT	FT	FT		
12	62.5	62.5	137.5	150.0	162.5	175.0	187.5	200.0	212.5	225.0	62.5	62.5	137.5	150.0	162.5	175.0	187.5	200.0	212.5	225.0	62.5	62.5	137.5	150.0	162.5	175.0	187.5	200.0	212.5	225.0	62.5	62.5	137.5	150.0	162.5	175.0	187.5	200.0	212.5	225.0

THREE CABLE GUARDRAIL AT OBSTRUCTIONS  
50 MPH DESIGN  
LENGTH OF NEED TABLES



THREE CABLE GUARDRAIL DIMENSION LAYOUT

- NOTES:
- ① The width of the obstruction shall be rounded up to the nearest 12'-6" length.
  - ② The 62'-6" dimension is the minimum length beyond an obstruction that may be placed.













### III-14.01 Safety Review Process

Safety Reviews are items for the project development process for Minor Rehabilitation, Structural Improvement, and Major Rehabilitation projects. The Safety Review project development process is outlined in detail within the flow chart shown in Chapter 2 Section 2 Appendix A “Milestone Flow Charts” (Section II-02A) of the Design Manual

### III-14.02 Safety Review Investment Strategy & Scope of Work

There are 3 different types of Safety Reviews, which are dependent on the project investment strategy contained within the *DESIGN GUIDELINES*, Chapter 1 Section 6 (Section I-06) of the Design Manual:

- Minor Rehabilitation Safety Review (SRMIR)
- Structural Improvement Safety Review (SRSIM)
- Major Rehabilitation Safety Review (SRMAR)

The above listed Safety Reviews have different scopes of work as a result of the investment strategy for the project. The guidance contained within following sections of this document may not apply to the scope of the specific Safety Review being completed for the particular project. Therefore, not all of the guidance within the following sections may be proposed with the particular Safety Review if not within the scope.

Safety Review templates and information regarding what is contained within the scopes of work for the various types of Safety Reviews shown above are available on the Design Manual “Reference and Forms” webpage at:

<http://www.dot.nd.gov/manuals/design/designmanual/reference-forms.htm>

### III-14.03 Clear Zone

Clear zone is defined as the total roadside area, beyond the edge of the through traveled way, which is traversable and free of obstructions. The clear zone value used for the design and recommendations within the Safety Review vary with the investment strategy as shown in the *DESIGN GUIDELINES*, Chapter 1 Section 6 (Section I-06) of the Design Manual. All references to clear zone hereinafter within this document and within the particular Safety Review shall be the clear zone as designated by the *DESIGN GUIDELINES* for the particular project:

- Minor Rehabilitation clear zone = Use existing
- Structural Improvement clear zone = 20' NDDOT clear zone\*
- Major Rehabilitation (ADT < 2000) clear zone = 20' NDDOT clear zone\*
- Major Rehabilitation (ADT > 2000) clear zone = AASHTO clear zone, see Chapter 3 Section 14 Appendix B of the Design Manual (Section III-14B)

*\*If circumstances result in the AASHTO clear zone value less than the NDDOT 20' clear zone such as in urban/low speed areas, the AASHTO clear zone value may be used instead.*

### III-14.04 Field Survey

The field surveys are made to determine the location and size of all obstructions along the roadway. Refer to Chapter 18 of the Survey Manual for an explanation of the data collection process.

### III-14.05 Safety Enhancements

All obstructions within the clear zone should have one of six safety enhancements performed. In order of preference, these are:

1. Remove the obstruction.
2. Make the obstruction traversable.
3. Relocate the obstruction beyond the clear zone.
4. Reduce impact severity by using an appropriate breakaway system.
5. Shield the obstruction with a longitudinal barrier or crash cushion (only if obstruction cannot be removed, relocated, or redesigned.)
6. Delineate the obstruction (only if all above options are not appropriate.)

Attenuation devices, guardrail, and breakaway systems to be installed should be of a type that has been crash tested successfully in accordance with “Recommended Procedure for the Safety Performance Evaluation of Highway Features” (NCHRP) Report 350.

The basic concept of the breakaway support is to provide a structure that will resist wind and ice loads, yet fail in a safe and predictable manner when struck by a vehicle. The term “breakaway support” refers to all types of sign, luminaire, and traffic signal supports that are designed to yield when struck by a vehicle. The release mechanism may be a slip base, base-bending, fracture elements, or a combination of these.

### III-14.06 Obstructions

An obstruction is anything that would hinder the recovery/movement of a vehicle that has left the traveled way. Obstructions include, but are not limited to: a rigid object with a height greater than 4 inches, non-yielding/non-breakaway signs, light standards, and utility poles, signal standards, culvert (or end section) openings over 36 inches, multiple openings greater than 30 inches, box culverts, bridge rail ends, bridge piers, trees having a mature diameter of 4” or larger, large rocks, water over 2 feet deep, and foreslopes that are steeper than 3:1. The *Roadside Design Guide*, published by AASHTO, contains the guidelines used to determine what constitutes an obstruction and how the obstruction should be dealt with. The following sections describe some of the more common obstructions found alongside the roadway.

### III-14.06.01 Roadside Signs

Roadside signs can be divided into three main categories: overhead signs, large roadside signs, and small roadside signs. The hardware and corresponding safety treatment of sign supports varies with the sign category.

1. Overhead signs: Where possible, overhead signs should be installed on overpasses or other structures. Overhead signs generally require massive support systems which cannot be made breakaway. All overhead sign structures located within the clear zone should be shielded with crashworthy barriers.
2. Large Roadside Signs: Large roadside signs may be defined as those greater than 50 ft<sup>2</sup> in area. They typically have two or more steel pipe or W-shape support posts which are breakaway. The following criteria should be satisfied if the support is to perform adequately as a breakaway support:
  - The hinge should be a minimum of 7ft above the ground surface.
  - A single post, or multiple posts with a post spacing greater than 7ft, should have a weight less than 45 lb/ft with a total weight of the support between the hinge and the breakaway base not to exceed 600 lb. For two or more posts with a post spacing less than 7ft, the post should not have a weight less than 18 lb/ft.
  - No supplemental sign should be attached below the hinges. The sign may interfere with the performance of the breakaway support and/or it may enter the windshield if the sign is struck.
  - The base plate of the anchoring unit shall not protrude above the ground more than 4" (see Figure 1 in Appendix III-14 A.)
3. Small Roadside Signs: Small roadside signs can be identified as signs having a sign surface area less than 50 ft<sup>2</sup> and they may be supported on one or more posts. A single support post is generally made of steel pipe or perforated tube and multiple supports are generally made of perforated tubes.
  - Sign supports that are made from 2 1/4" 12 gauge steel or smaller square perforated tube (and do not have a reinforcing sleeve) are considered to be base-bending and do not require a breakaway base.
  - U-channel posts, when used as single posts, are also considered base-bending and do not require a breakaway base. The U-channel post should not be spliced unless it has been crash tested.
  - Sign supports that are made of wood, buried a minimum of 3ft in the ground, and 4"x 4" or smaller will yield when struck by a vehicle. Posts made of wood that are larger than 4"x 4" need to be weakened by having two holes drilled perpendicular to the roadway into the base of the sign support (see Figure 2 in Appendix III-14 A.)

- Supports made with steel pipe are not considered to be base-bending and are required to have a breakaway base.
- Diagonal bracing, also known as “A-frame”, sign supports should not be used.
- The base plate of the anchoring unit shall not protrude above the ground more than 4” (see Figure 1 in Appendix III-14 A.)

### III-14.06.02 Steep Foreslopes

Foreslopes parallel to the roadway can be categorized as recoverable, non-recoverable (traversable), or critical. A vehicle entering a critical foreslope is likely to overturn. A critical foreslopes is classified as a slope that has a rate steeper than 3:1.

When the foreslope is considered critical, the fill height and ADT of the roadway is examined. The depth of the fill is measured from the toe of the critical slope at the tie in with the ditch bottom to the top of the slope.

- If the fill height is 10’ or less or if the forecast ADT is 750 or less, it is not considered cost effective to improve the slope.
- If the fill height is greater than 10’ and the forecast ADT is greater than 750, foreslope flattening or guardrail protection should be considered.

It may be more cost effective to flatten foreslopes even though the initial cost may be greater than guardrail. The Safety Review shall determine if flattening foreslopes or guardrail is more cost effective. The cost effectiveness is based on crash costs and the cost to install the fill material. The flattening of foreslopes should be proposed for the project if cost effective. If guardrail is determined more cost effective, an executive decision item within the environmental document shall added to determine if guardrail should be used, or if the foreslopes should be flattened.

There may be circumstance where flattening foreslopes is more cost effective, but cannot be done because of right of way impacts, environmental factors, or other special circumstances.

Many times drainage structures are located within steep slope areas. These structures may need to be extended when the slope is flattened. The cost for the extensions should be included in the cost to flatten the slopes. Use Chapter 3 Section 15 (Section III-15) of the Design Manual to determine how the foreslope should be flattened.

### III-14.06.03 Cross Slopes (Transverse Slopes)

Common obstacles on the roadside are embankment slopes created by median crossings, driveways, intersecting side roads, and ditch blocks. These slopes are more critical to errant vehicles than foreslopes and backslopes because they are struck by the vehicle directly. Cross slopes of 6:1 or flatter are acceptable, but median crossings and ditch block embankment cross slopes of 10:1 are desirable.

- All ditch block cross slopes steeper than 6:1 should be flattened.
  - On Interstate highways, they should be flattened to 10:1.
  - On all other roadways, they should be flattened to 8:1.
- The cross slopes of median crossings on the Interstate highways that are steeper than 6:1 should be flattened to 10:1 (see Figure 3 in Appendix III-14 A).
- Cross slopes of median crossings and side road approaches (all roadways except the Interstate) that are steeper than 6:1 should be flattened to 8:1. The following criteria should be used when flattening the cross slopes:
  - Flatten all 4:1 or steeper cross slopes where the forecast ADT is less than 500
  - Flatten all cross slopes between 4:1 and 6:1 where the forecast ADT is less than 500 and it is cost effective
  - Flatten all cross slopes steeper than 6:1 where the forecast ADT is greater than 500
  - Culverts located with the cross slopes may need to be extended when the slope is flattened.

#### III-14.06.04 Cross-Drainage Structures

Cross-drainage structures are used to move water under the roadway. They may consist of reinforced concrete pipes, corrugated metal pipes, structural plate pipes, or concrete box culverts. These structures can also be used by pedestrians, vehicles, or animals.

Cross-drainage structures with openings within the clear zone should be made traversable, extended beyond the clear zone, or shielded with guardrail. Single structures with openings 36" or less and multiple structures with openings 30" or less are considered to be traversable and do not need to be improved. The openings for centerline pipes are measured at the opening of the flared end section if present, otherwise are measured at the pipe opening if no end sections are present. For example, a single 36" centerline pipe with a flared end section would not be considered traversable because the opening of the flared end section is greater than 36". If a single 36" centerline pipe exists with no end section, it may be considered traversable as the pipe opening is only 36".

Grates can be installed to make the openings of the cross-drainage structures traversable (see Figure 4 in Appendix III-14 A.) Smaller diameter (15" to 36") reinforced concrete pipes can be made traversable by removing the flared end section and installing a traversable end section. See Standard Drawings for traversable end sections.

- A cost effective analysis should be performed on all structures with openings within the clear zone on roadways with a forecast ADT greater than 750. If it is determined that it is not cost effective to improve the structure, object markers should be installed.
- It is not considered cost effective to improve structures with openings within the clear zone on roadways with a forecast ADT of 750 or less. Therefore, these structures should have object markers installed.

### III-14.06.05 Parallel Drainage Structures

Parallel drainage structures are those which parallel the mainline flow of traffic. These features can present a significant safety obstruction because they can be struck head-on by errant vehicles. Safety treatment options are similar to those for cross drainage structures:

- Eliminate the structure
- Use a traversable design
- Move the structure laterally to a less vulnerable location
- Shield the structure

Eliminating the structure may be difficult, but on field entrances and very low volume driveways, an overflow section may be constructed.

Traversable designs are to provide grates constructed of pipes set on 24 inch centers to reduce wheel snagging. Generally, pipes of 24 inch diameter or less may not require a grate. However, when a multiple pipe installation is encountered, grating smaller pipes may be appropriate.

Relocating the structure is the most desirable. This allows the opportunity to flatten the cross slope within the clear zone distance of the roadway. If the new culvert is located beyond the clear zone of the roadway, and will also be beyond the clear zone for the approach roadway, then relocation of the drainage structure should be considered. When a structure is relocated, it should be moved to at least 60 feet from the centerline of the roadway.

In cases where the cross slope cannot be made traversable, and the structure cannot be relocated or is too large to be safety treated effectively, it may be necessary to shield the obstacle with a traffic barrier.

### III-14.06.06 Water

Streams or bodies of water with a depth of more than 2 feet within the clear zone should be moved beyond the clear zone or shielded. A cost effective analysis should be performed to determine what action should be taken. The water should be present for long periods of time (one year or longer.)

### III-14.06.07 Riprap

Riprap that is within the clear zone and extends above the surrounding ground surface more than 4" should be removed to the clear zone or shielded. A cost effective analysis should be performed to determine what action should be taken.

If erosion control is necessary, an erosion control blanket should be installed after the riprap is removed. The cost for the erosion control blanket should be included in the cost for removing the riprap when the cost analysis is performed.

**III-14.06.08 Light Standards, Signal Standards, Utility Poles, Trees, and Similar Roadside Features**

Roadside features that are within the clear zone and protrude above the surrounding surface more than 4" should be removed, made breakaway, relocated beyond the clear zone, or shielded.

Features, such as signal standards (with mast arms), utility poles, and railroad signals, cannot be made breakaway and should be relocated beyond the clear zone or shielded. Sometimes, features such as these need to be close to the roadway and cannot be relocated. In these instances, consideration should be given to installing a crash cushion to shield the supports.

Light standards and signal standards (without mast arms) should be made breakaway or relocated beyond the clear zone.

Trees with a mature size greater than 4" in diameter should be removed. If they cannot be removed they should be shielded.



### III-14.06.09 Bridge Rail

The bridge railing should be of a type that is crashworthy. The bridge rails that the department uses and has accepted are: Jersey Barrier and Double Box Beam Rail Retrofit. Other types of bridge rail, such as the Sloped E-Rail, should be modified to a Double Box Beam Rail Retrofit.

### III-14.06.10 Guardrail

For Minor Rehabilitation and Structural Improvement investment strategies, guardrail that has not been successfully crash tested in accordance with the guidelines of NCHRP Report 230 should be replaced with guardrail that has been successfully crash tested in accordance with the guidelines as set forth in NCHRP Report 350. Guardrail should be checked to ensure that it meets the requirements based on the existing ADT and posted speed less 10 mph of the roadway, and the variation for height of rail cannot be more than  $\pm 3$  inches of the design dimension when originally installed. See *DESIGN GUIDELINES*, Chapter 1 Section 6 (Section I-06) of the Design Manual.

For Major Rehabilitation investment strategies, guardrail shall meet guidelines as set forth in NCHRP Report 350. See *DESIGN GUIDELINES*, Chapter 1 Section 6 (Section I-06) of the Design Manual. Guardrail should be checked to ensure that it meets the requirements based on the forecast ADT and design speed of the roadway.

If one or more of the following deficiencies is present, the guardrail should be replaced with guardrail that meets current design practices:

- Guardrail that is attached to a safety shape transition (only if there is another deficiency or the approach slab is being replaced.)
- Guardrail tapers away from the roadway at a greater rate than what is required.
- There is insufficient space between guardrail and obstruction for proper deflection.
- The distance from the top of the guardrail to the ground surface is less than 27" or greater than 29" (after roadway improvement.)
- The guardrail is not long enough to shield the obstruction from an errant vehicle (see Length of Need in Section III-13 Guardrail.)

### III-14.06.11 T-Intersection

Whenever a county, state, or US highway has an intersection or dead end with another state or US highway, there should be an approach or escape road provided for errant vehicles. If it is not feasible, other protective devices such as warning signs, rumble strips, or barricades should be provided (see Design Manual Section III-03.05.03 "Recovery Approaches").

### III-14.07 Cost Effective Analysis

Collisions involving vehicles with roadside objects are a probable occurrence with any existing highway facility. The purpose of cost effective analysis is to provide a technique for comparing alternate solutions to problem locations. Present value of the total cost of each alternative is computed over a given period of time, taking into consideration initial cost, maintenance cost, and accident cost. The costs for each alternative are compared to the cost of the accidents that would occur if no safety enhancements were performed. The option with the least total cost would normally be chosen.

The Road Safety Analysis Program (RSAP) Software was developed under National Cooperative Highway Research Program (NCHRP) Project 22-9 and represents one approach to using the procedures described in Appendix A of the 2002 AASHTO *Roadside Design Guide*. The research for NCHRP Project 22-9 can be found in NCHRP Report 492, *Roadside Safety Analysis Program (RSAP)—Engineer's Manual*. The RSAP program is intended as a tool for economic analysis and should not supersede the guidelines presented in the *Roadside Design Guide* or sound engineering judgment.

The cost of making the improvements to enhance the safety of the roadside should be used to determine if the improvements are cost effective. The initial cost to make the improvements should be estimated to the nearest 100 dollars.

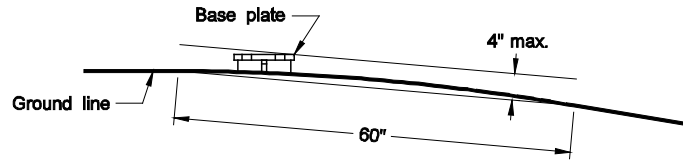
The maintenance costs to maintain the improvements should be on an annual basis. When guardrail is the improvement, the price for removal of snow should be included in the maintenance costs. Generally, a value of \$10 per linear foot is used for snow removal maintenance costs for W-beam guardrail. No snow removal maintenance costs for 3-cable guardrail is typically used.

The salvage value for the improvements at the end of the project life is typically considered zero, but may be used for W-beam guardrail. Note: If using the Road Safety Analysis Program (RSAP) software, it is not possible to input a salvage value.

The project life of a roadway design is an input value selected by the user. The discount rate is also a basic input value in the economic analysis. Generally, a value of 10% is used for the discount rate.

Once the information is obtained, the total present worth and annualized costs are computed. The Road Safety Analysis Program (RSAP) software has been prepared to make a direct comparison between several proposed safety treatments.

- Figure 1 Breakaway Support Stub Height Measurement
- Figure 2 Breakaway Wood Sign Supports
- Figure 3 Median Cross Slope Designs
- Figure 4 Safety Treatment for Cross-Drainage Pipes and Culverts



Maximum projection of base plate shall not extend above a line, 4" parallel to any chord, which is perpendicular to (or aligned radially to) the center line of the highway and has the chord's end points on the ground surface on opposite sides of the stub post.

Figure 1 - Breakaway Support Stub Height Measurement

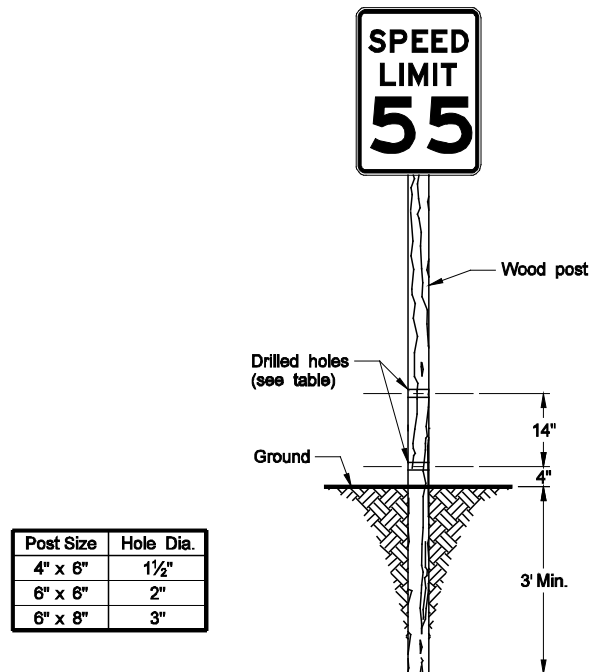
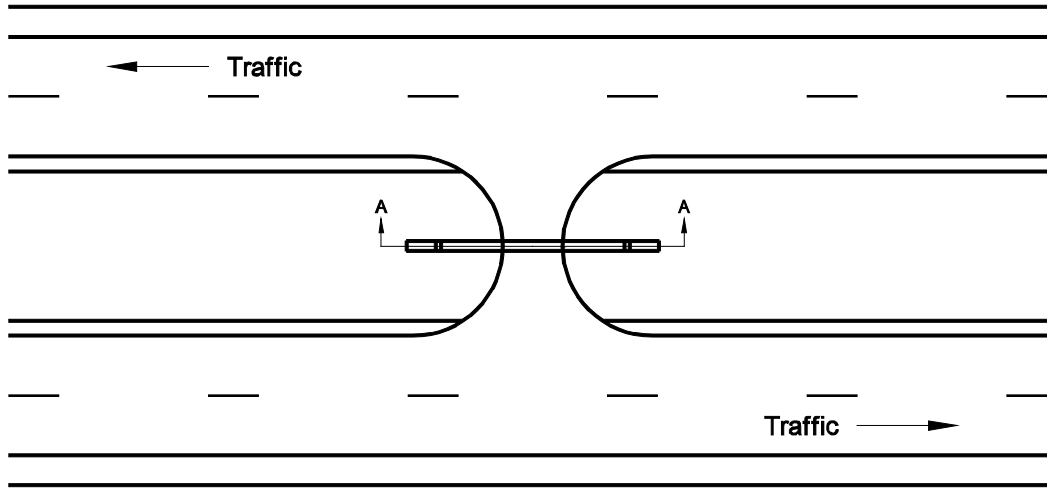
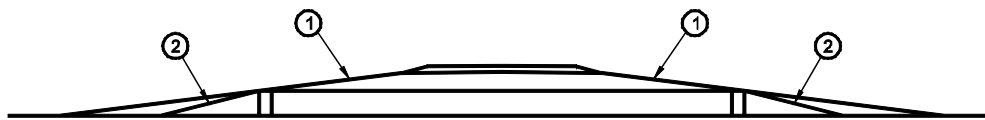


Figure 2 - Breakaway Wood Sign Supports



Median Crossings



Section A-A

- ① Slope 10:1 or flatter desirable on interstate  
Slope 8:1 or flatter desirable on all other roadways  
6:1 maximum on high-speed, high-volume facilities
- ② End treatment as required to meet proposed slope.

Note: Use of the flattest possible median cross slope on high speed highways, particularly within the appropriate clear zone area, can provide an improved roadside. Safety treatment of culverts as discussed in Cross Slopes (Transverse Slopes) may further enhance the improvement.

Figure 3 - Median Cross Slope Design

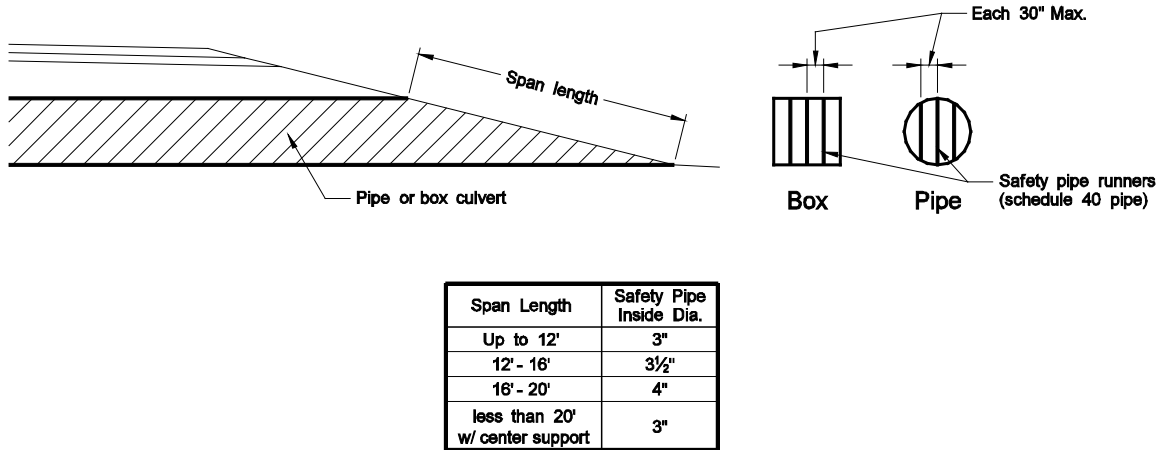


Figure 4 - Safety Treatment for Cross-Drainage Pipes and Culverts

Table 1 Clear Zone Distance

Table 2 Horizontal Curve Adjustment

**Table 1 CLEAR ZONE DISTANCE (in Feet from Edge of Driving Lane)<sup>3</sup>**

DESIGN SPEED	DESIGN ADT***	FORESLOPE					BACKSLOPE				
		FLAT	1V: 6H	1V: 5H	1V: 4H	1V: 3H	1V: 3H	1V: 4H	1V: 5H	1V: 6H	FLAT
40 mph or less	Under 750	7-10	7-10	7-10	7-10	**	7-10	7-10	7-10	7-10	7-10
	750-1500	10	12	12	14	**	12-14	12-14	12-14	12-14	12-14
	1500-6000	12	14	14	16	**	14-16	14-16	14-16	14-16	14-16
	Over 6000	14	16	16	18	**	16-18	16-18	16-18	16-18	16-18
45-50 mph	Under 750	10	12	12	14	**	8-10	8	10	10	12
	750-1500	14	16	16	20	**	10-12	12	14	14	16
	1500-6000	16	18	20	26	**	12-14	14	16	16	18
	Over 6000	20	22	24	28	**	14-16	18	20	20	22
55 mph	Under 750	12	14	14	18	**	8-10	10-12	10-12	10-12	10-12
	750-1500	16	18	20	24	**	10-12	14	16	16	18
	1500-6000	20	22	24	30	**	14-16	16	18	20	22
	Over 6000	22	24	26	32*	**	16-18	20	22	22	24
60 mph	Under 750	16	18	20	24	**	10-12	12	14	14	16
	750-1500	20	24	26	32*	**	12-14	16	18	20	22
	1500-6000	26	30	32*	40*	**	14-18	18	22	24	26
	Over 6000	30	32*	36*	44*	**	20-22	24	26	26	28
65-75 mph	Under 750	18	20	20	26	**	10-12	14-16	14-16	14-16	14-16
	750-1500	24	26	28	36*	**	12-16	18	20	20	22
	1500-6000	28	32*	34*	42*	**	16-20	22	24	26	28
	Over 6000	30	34*	38*	46*	**	22-24	26	30	28	30

\*Where a site specific investigation indicates a high probability of occurrences are indicated by crash history, the designer may provide clear zone distance greater than 30 feet as indicated. Clear zone may be limited to 30 feet for practicality and provide a consistent roadway template if previous experience with similar projects or design indicates satisfactory performance.

\*\*Since recovery is less likely on unshielded traversable 3:1 slopes, fixed objects should not be present in the vicinity of the toe of these slopes. Recovery of high speed vehicles that encroach beyond the edge of the shoulder may be expected to occur beyond the toe of the slope. Determination of the width of the recovery area at the toe of the slope should take into consideration right of way availability, environmental concerns, economic factors, safety needs and crash histories. Also, the distance between the edge of the travel lane and the beginning of the 3:1 slope should influence the recovery area provided at the toe of the slope. While the application may be limited by several factors, the fill slope parameters, which may enter into determining the maximum desirable recovery area, is illustrated in Figure 3-2, AASHTO Roadside Design Guide (2011).

\*\*\*Design ADT is the total ADT for both directions of travel for the design year. This applies to both divided and undivided facilities. Typically is based on the 20 year projected ADT.

<sup>3</sup>AASHTO Roadside Design Guide (2011), Table 3-1



Table 2

**HORIZONTAL CURVE ADJUSTMENT<sup>4</sup>**

**Kcz (Curve Correction Factor)**

Radius (ft)	Design Speed (mph)					
	40	45	50	55	65	70
2,950	1.1	1.1	1.1	1.2	1.2	1.2
2,300	1.1	1.1	1.2	1.2	1.2	1.3
1,970	1.1	1.2	1.2	1.2	1.3	1.4
1,640	1.1	1.2	1.2	1.3	1.3	1.5
1,475	1.2	1.2	1.3	1.3	1.4	1.5
1,315	1.2	1.2	1.3	1.3	1.4	-
1,150	1.2	1.2	1.3	1.4	1.5	-
985	1.2	1.3	1.4	1.5	1.5	-
820	1.3	1.3	1.4	1.5	-	-
660	1.3	1.4	1.5	-	-	-
495	1.4	1.5	-	-	-	-
330	1.5	-	-	-	-	-

$$CZc = (Lc)(Kcz)$$

Where: CZc = clear zone on outside of curvature in feet.

Lc = clear zone distance in feet, Table 1 this Appendix.

Kcz = curve correction factor.

Note: Clear zone correction factor is applied to outside of the curve only.

Corrections are typically made only to curves less than 2,950-ft radius.

---

<sup>4</sup>AASHTO Roadside Design Guide (2011), Table 3-2

### III-15.01 Introduction

This section discusses foreslopes at areas with fills (over 7' deep), steep foreslopes (slopes steeper than 3:1), and box culverts (or other culverts.) Because of terrain, right-of-way, and other issues it may not be possible to eliminate the steep slope or extend the box culvert. Providing recoverable foreslopes (4:1 or flatter) adjacent to the roadway in these areas can give an errant vehicle the necessary room to recover and avoid the steep foreslopes and box culverts.

The configuration of the foreslope cross sections used in areas of fills (over 7' deep), steep foreslopes, and box culverts is based upon the forecast ADT as shown in the Project Concept Report and the depth of the fill at the deepest location. The depth of the fill is measured from the toe of the foreslope at the tie in with the ditch bottom to the edge of the finished shoulder (see Figure 1.)

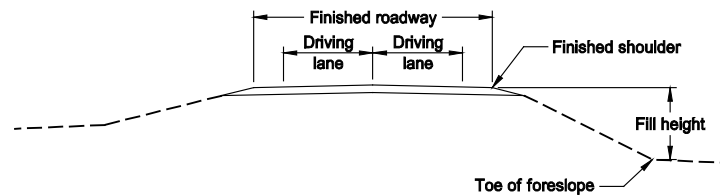


Figure 1 – Fill Height

### III-15.02 Foreslope Configuration

The foreslope configurations are divided into two basic groups. The first group has an initial foreslope rate of 6:1 and the second group has an initial foreslope rate of 4:1. The initial foreslope extends to the required clear zone and then continues, breaks to a secondary foreslope, or breaks to a bench section followed by a secondary foreslope (see Figure 2.) The required clear zone values used for the cost effective analysis of the foreslope configurations were taken from Section III-14B of the Design Manual.

The cost effective analysis was completed using various foreslope configurations to determine whether or not to flatten a foreslope. The analysis is based on crash costs, costs to extend box culverts, and costs to install the fill material to flatten the foreslope. The results of the analysis are graphically represented by foreslope configuration, annualized cost, and depth of fill (see Figures 4-15.) Each line represents a different foreslope configuration and is ranked from the lowest being the most cost effective to the highest being the least cost effective.

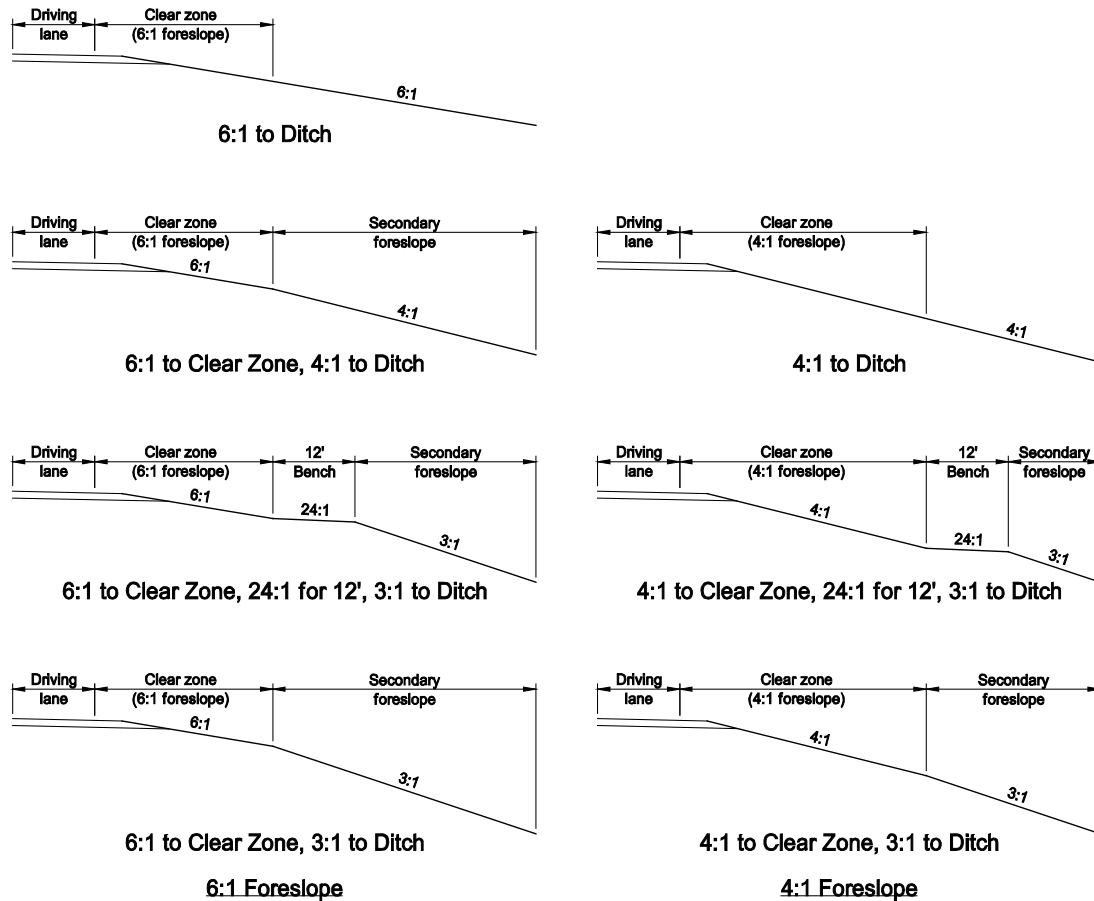


Figure 2 – Foreslope Configurations

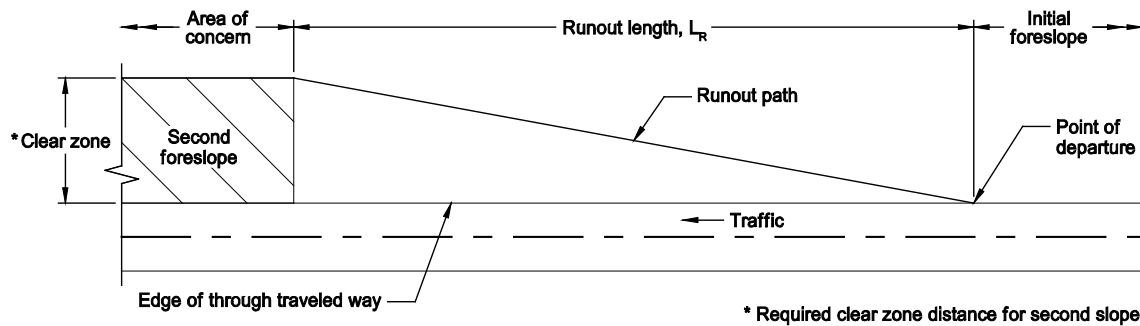
It is desirable to choose the most cost effective foreslope configuration based on the graphs. In some cases, site conditions may not allow the most cost effective foreslope configuration to be chosen. All foreslope configurations shown in the graphs are cost effective. Engineering judgment should be used to determine the best possible foreslope configuration based on cost effectiveness and site conditions.

Other foreslope configurations that are not shown in the graphs may be used if shown to be cost effective. The Materials and Research Division must be contacted before considering the use of a foreslope steeper than 3:1. Foreslopes with a rate steeper than 3:1 will normally require a soil stability analysis to show soil conditions are adequate to allow the use of such a foreslope. A bench section with a 12' wide 24:1 slope beginning at the clear zone is desirable with any foreslope steeper than 3:1 to provide a buffer for errant vehicles that may go beyond the clear zone.

**III-15.03 Foreslope Transitions**

Foreslope transitions should be used anytime the foreslope changes slope rates. Flatter foreslopes tend to allow vehicles to recover quicker, so they do not require as much clear zone distance. Because each foreslope will have a different required clear zone distance, a transition area should be provided between the clear zones. Using the transition will minimize the chance of an errant vehicle crossing between areas with different clear zones.

The foreslope transition should follow the errant vehicle's predicted runout path. The runout path is the line that connects the point at which the vehicle is assumed to leave the traveled way to the outside edge of the clear zone at the area of concern. The area of concern in this case would be the second foreslope. The point of departure would then be at the edge of the driving lane at a distance equal to or greater than the runout length measured upstream along the roadway from the point where the second foreslope extends to the clear zone. The runout length can be found in Section III-13 of the Design Manual. The foreslope transition would then start where the runout path intersects the finished shoulder. Figure 19 in Example 1 shows how to transition from a 4:1 foreslope to a 6:1 foreslope at an area with a fill (over 7' deep). For horizontal curves, the runout path should be adjusted to have the same degree of curvature as the roadway with an adjusted clear zone for the curve.



**Figure 3 – Runout Path**

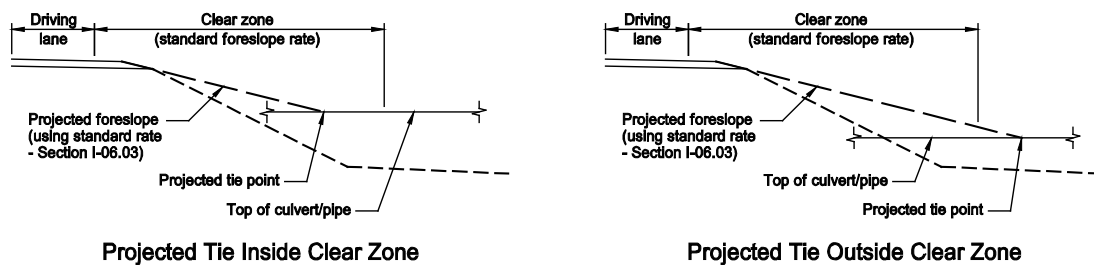
Typically, foreslopes are transitioned from a 4:1 to a 6:1, but using foreslopes that are 10:1 or flatter can reduce the required clear zone even further. In any case, the foreslope rate in the transition area should have the same rate as the foreslope in the area of concern.

**III-15.04 Standard Foreslope vs. Flattened Foreslope**

The foreslope rate at the obstructions such as box culverts, structural plate pipes, water over 2' deep, riprap, etc. should meet or exceed the desirable foreslope rate as shown in the Design Guidelines (Section I-06.03 of the Design Manual.) Using a foreslope that is flatter than the standard rate will reduce the required clear zone making it possible to place obstructions that are laterally constrained due to site conditions at or beyond the clear zone. Clear zone values can be found in Section III-14B of the Design Manual.

**III-15.04.01 Box Culverts and Structural Plate Pipes**

Using a foreslope that is flatter than the standard foreslope rate can sometimes reduce the length of a box culvert or structural plate pipe extension. To determine when to use a flatter foreslope, project a line with the standard rate until it ties into the top of the box culvert (see Figure 4.) If the line ties into the top of the box culvert inside of the clear zone, a flatter foreslope with a reduced clear zone will usually result in a shorter box culvert extension. If the line ties into the top of the box culvert at or beyond the clear zone, a flatter foreslope with a reduced clear zone will usually result in a longer box culvert extension. The foreslope configuration to be used can then be determined as stated in Section III-14.02 – Foreslope Configuration. A foreslope transition should be used to transition from the flatter foreslope to the standard foreslope. Figure 20 in Example 2 shows how to transition from a 4:1 foreslope to a 6:1 foreslope at a box culvert.



**Figure 4 – Foreslope Flattening at Box Culvert or Structural Plate Pipe**

**III-15.04.02 Water Over 2' Deep and Riprap**

Using a flatter foreslope at locations where water over 2' deep and/or riprap is within the clear zone can reduce the amount of fill needed. In cases where the water is high enough to threaten the roadway, a grade raise may be required to increase the elevation of the roadway. The flatter foreslope reduces the amount of vertical drop from the roadway to where the foreslope meets the clear zone, which can reduce the overall height of the grade raise.

Typically, a grade raise has a 10:1 foreslope to the clear zone followed by riprap and a 3:1 slope. See the Earthwork section of the Design Manual for more information on Grade Raises. A foreslope transition should be used to transition from the existing foreslope to the 10:1 foreslopes at the grade raise. Figure 21 in Example 3 shows a foreslope transition from a 4:1 foreslope to a 10:1 foreslope at a grade raise.

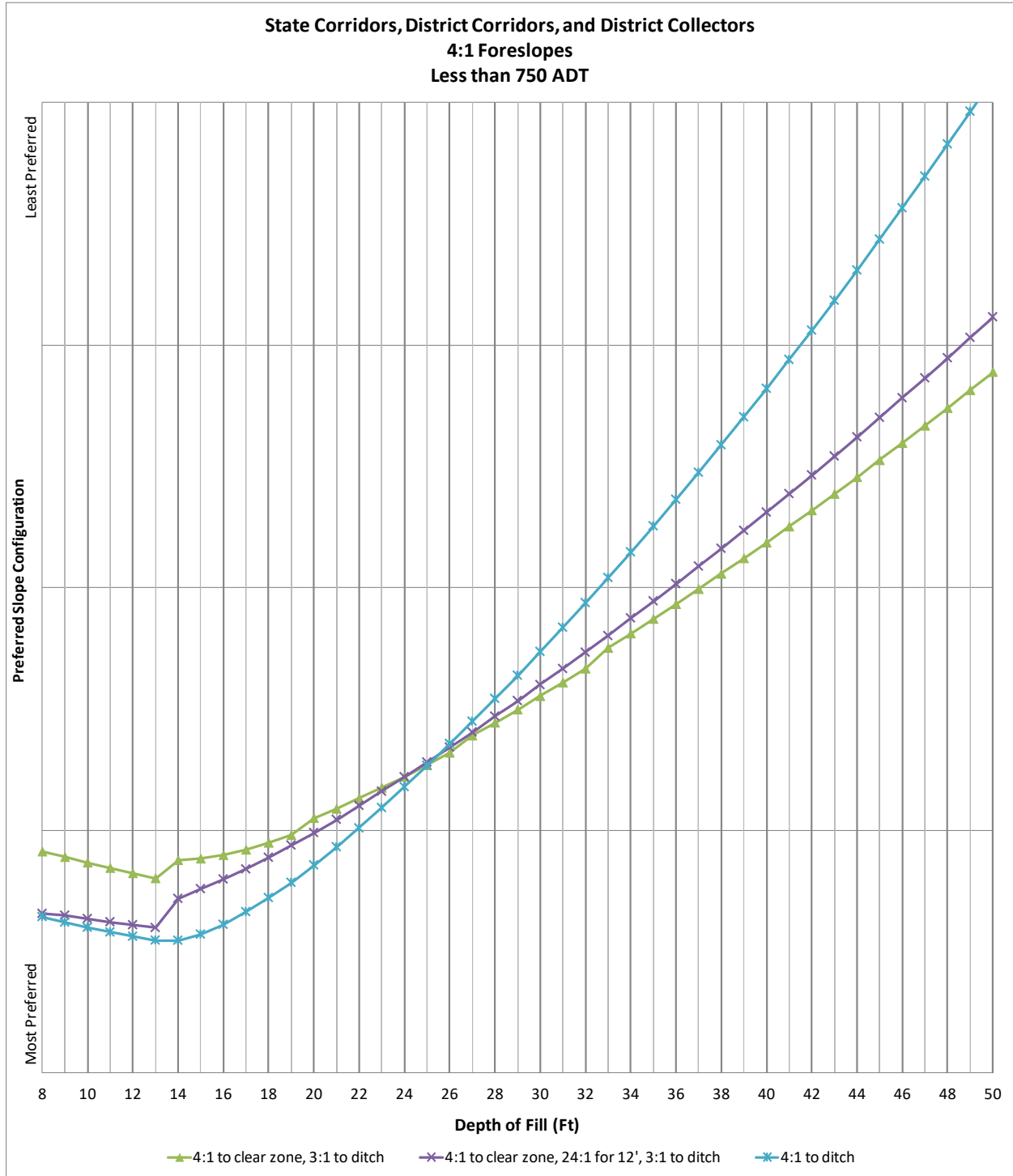
**III-15.05 State Corridor, District Corridor, and District Collector Highways**

This section addresses highways that are classified as a State Corridor, District Corridor, or District Collector. See Section III-14.06 for highways classified as Interregional or Interstate.

The proposed foreslope configuration should be chosen based on the desirable foreslope rate as shown in the Design Guidelines (Section I-06.03 of the Design Manual.) Figures 5-8 show foreslope configurations for a 4:1 foreslope rate and Figures 9-12 show foreslope configurations for a 6:1 foreslope rate.

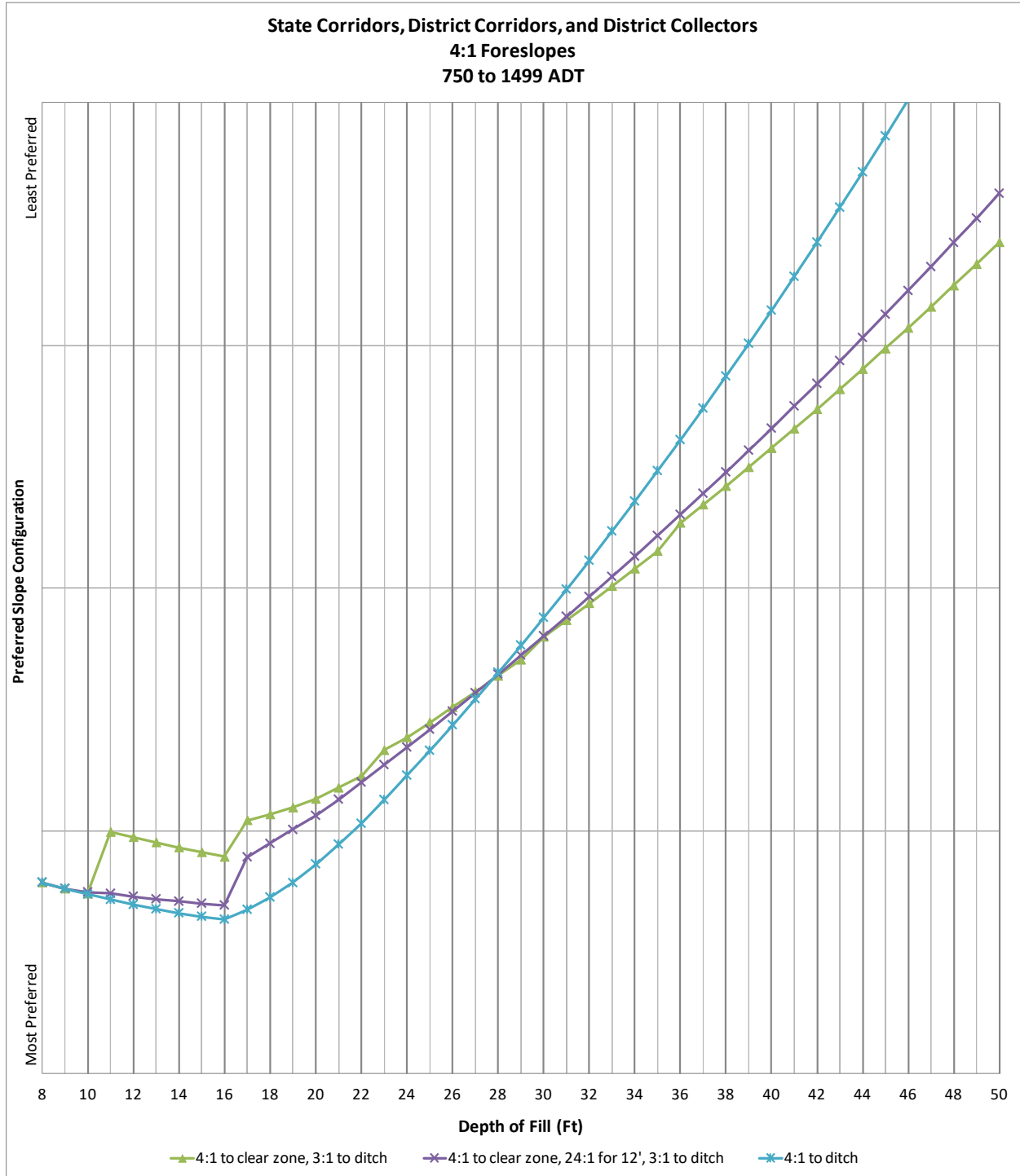
Foreslopes flatter than those shown in the Design Guidelines may be used in some cases as described in Section III-14.04 – Standard Foreslope vs. Flattened Foreslope.

## **4:1 Foreslope Configurations**

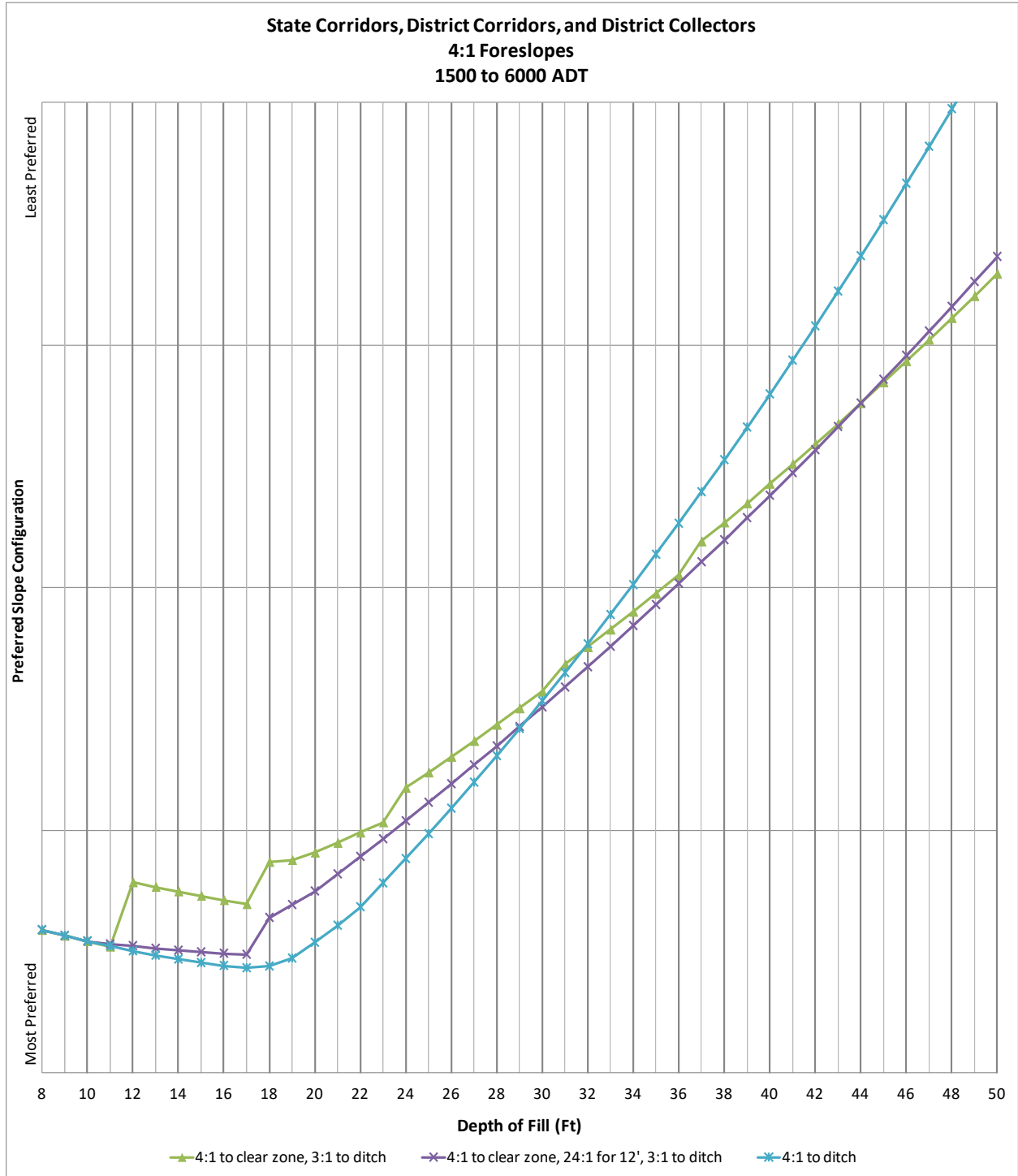


**Figure 5 – 4:1 Foreslopes (Less than 750 ADT)**

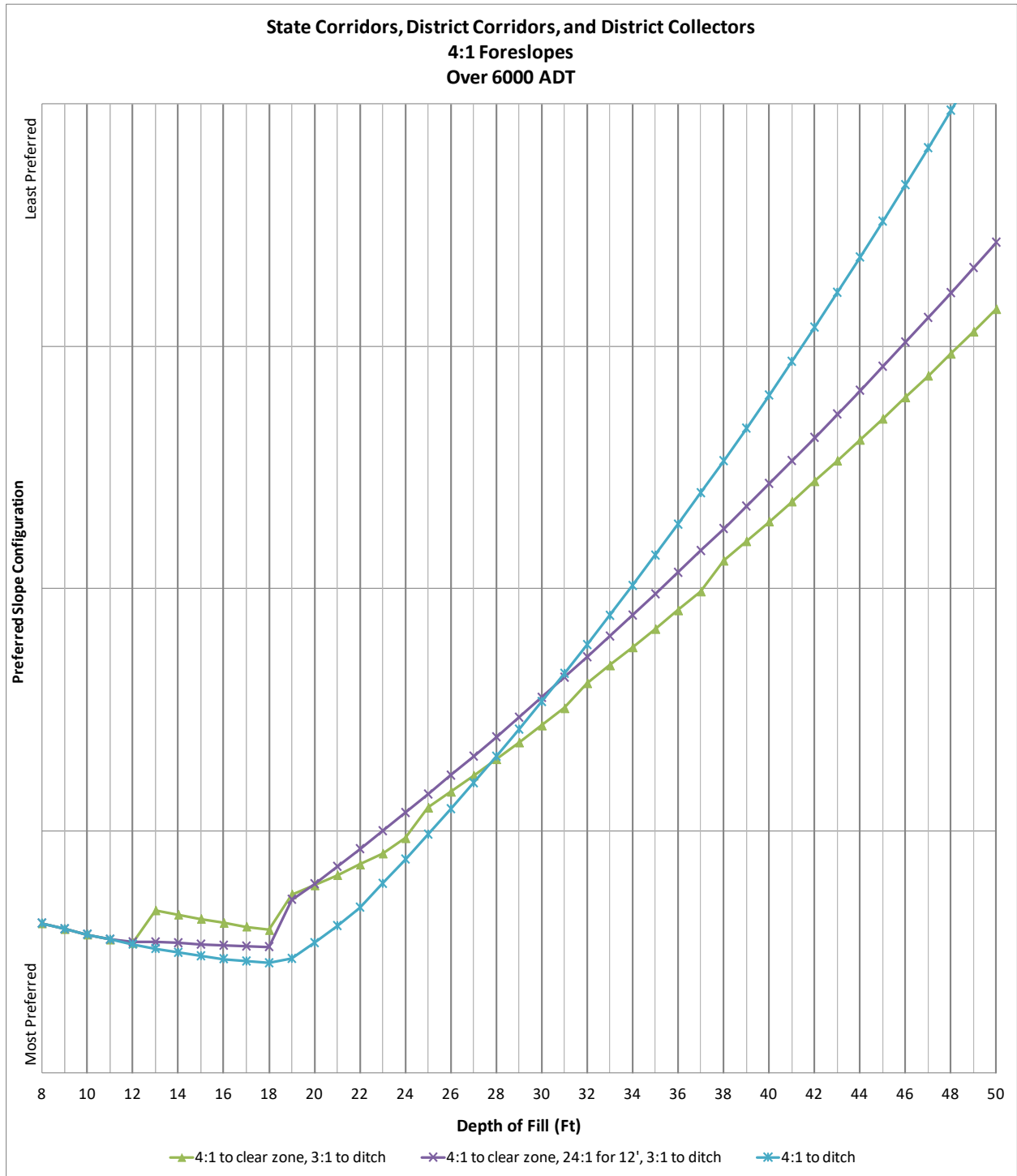




**Figure 6 – 4:1 Foreslopes (750 to 1499 ADT)**

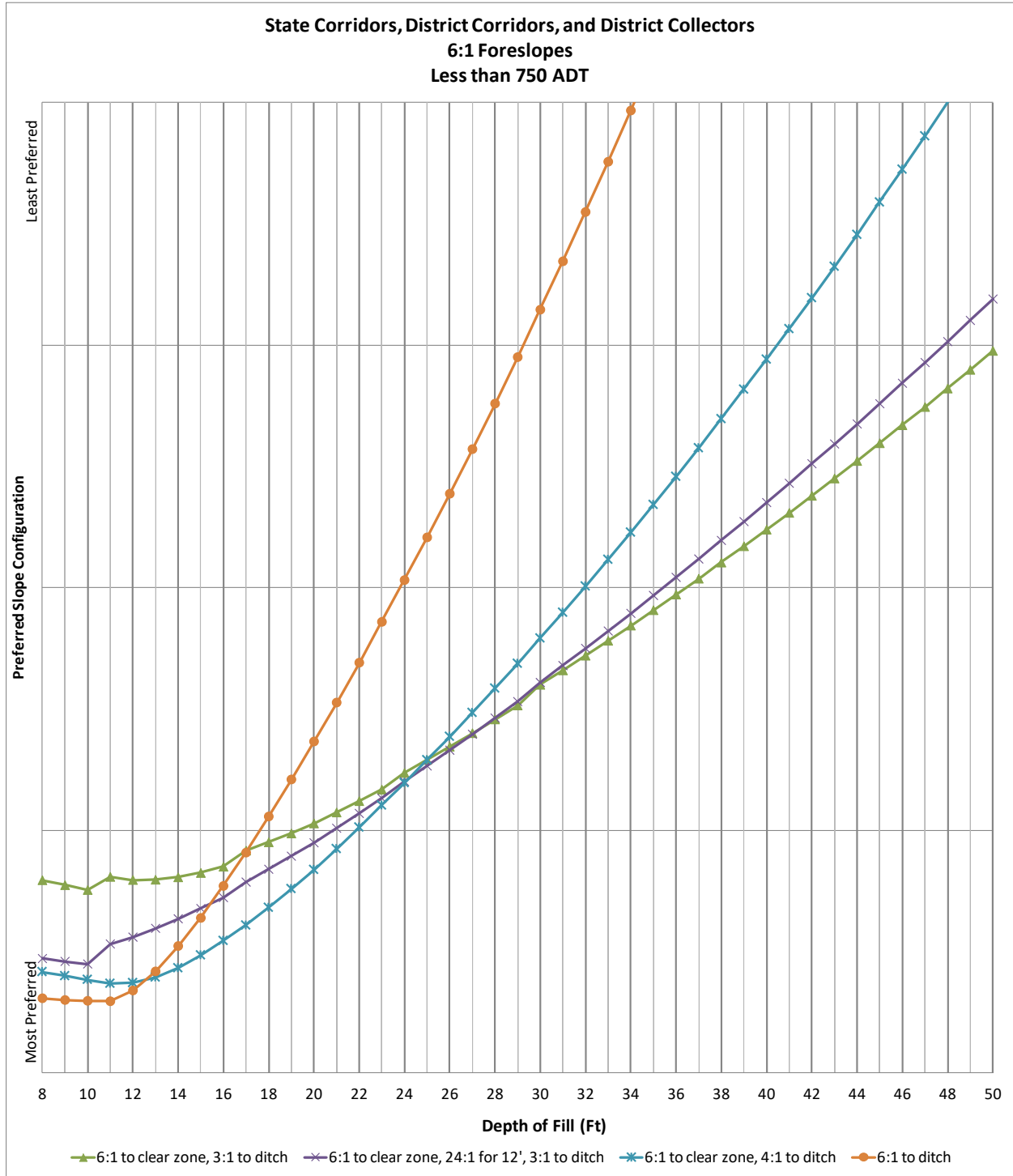


**Figure 7 – 4:1 Foreslopes (1500 to 6000 ADT)**

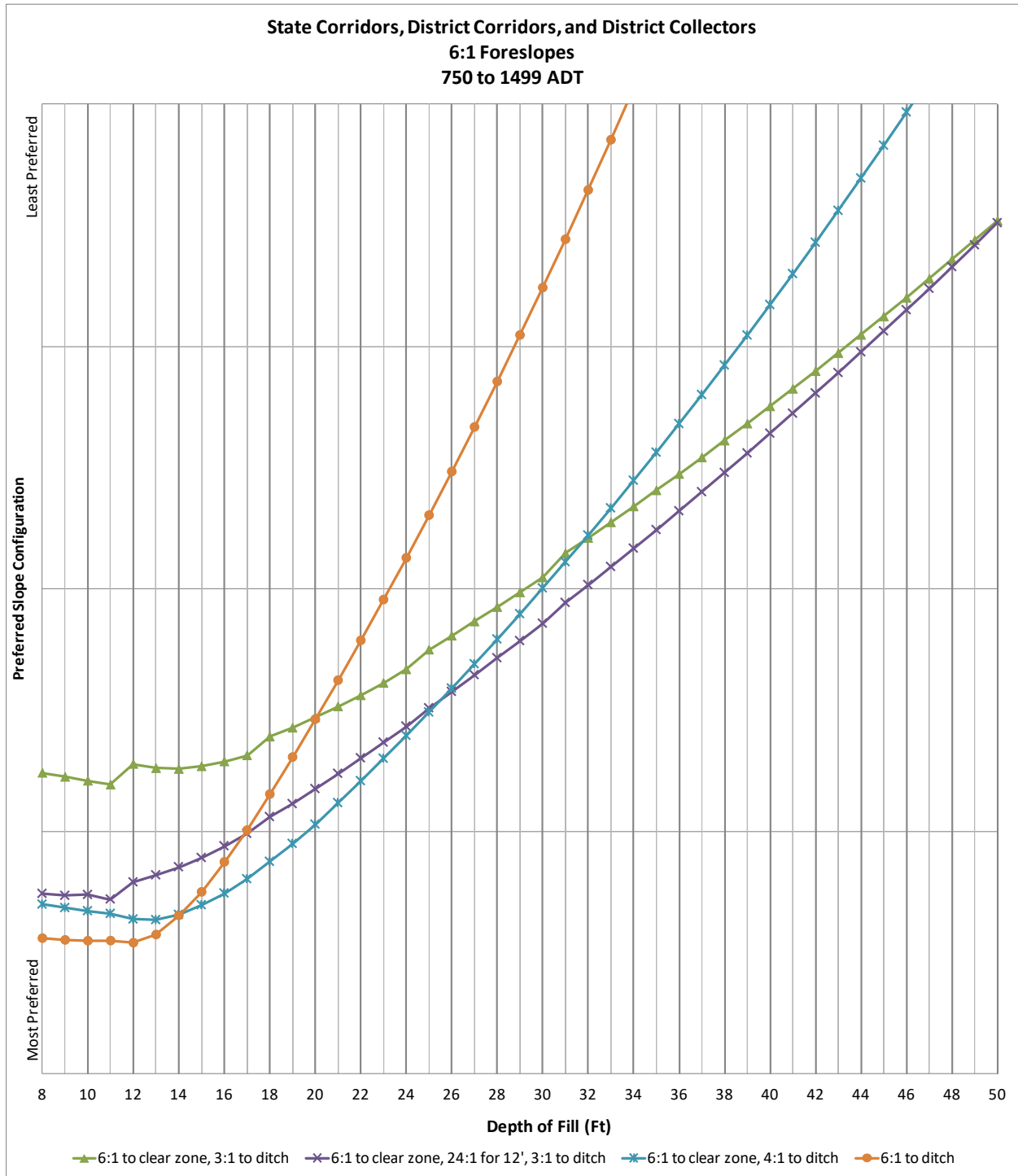


**Figure 8 – 4:1 Foreslopes (Over 6000 ADT)**

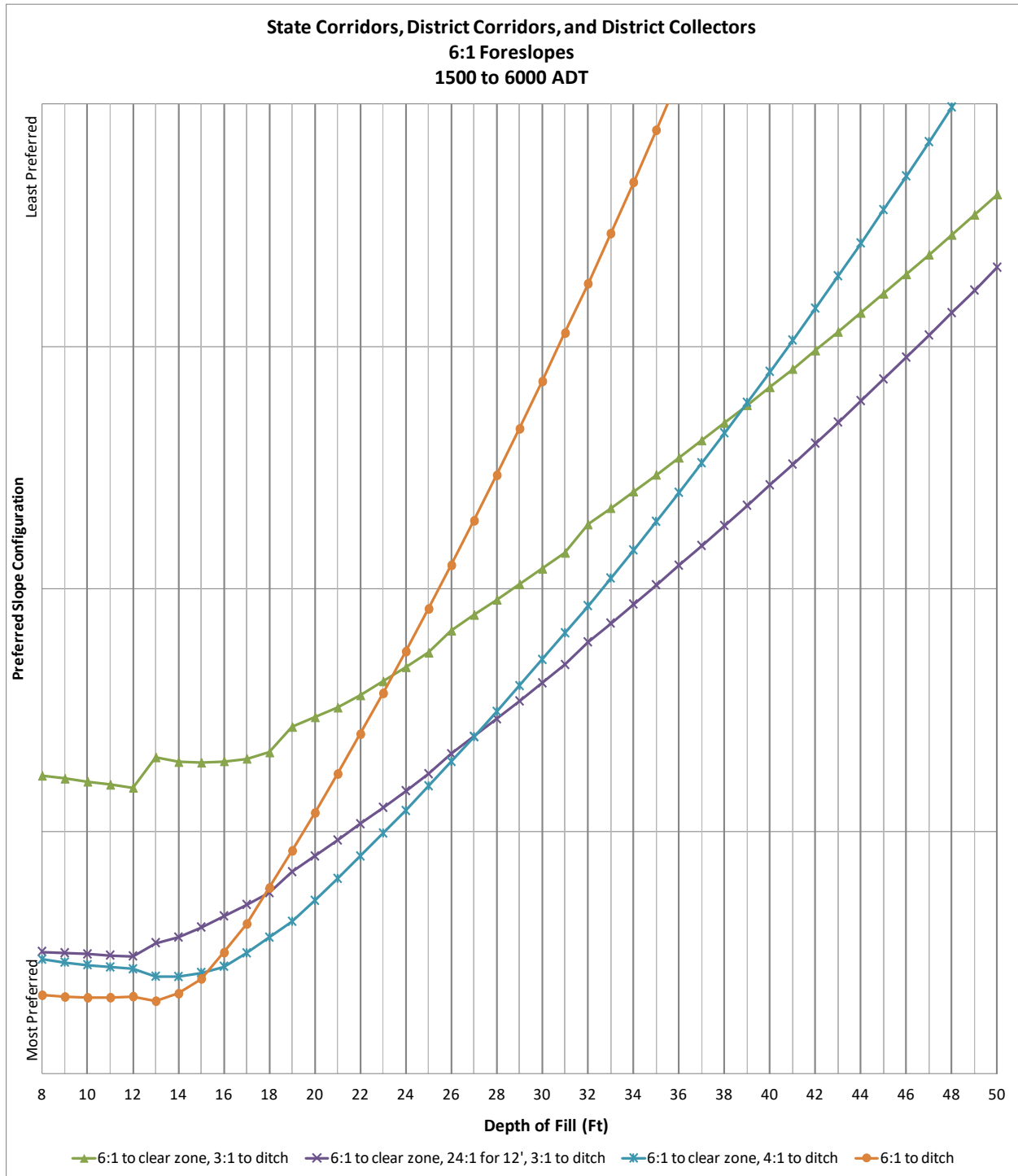
## **6:1 Foreslope Configurations**



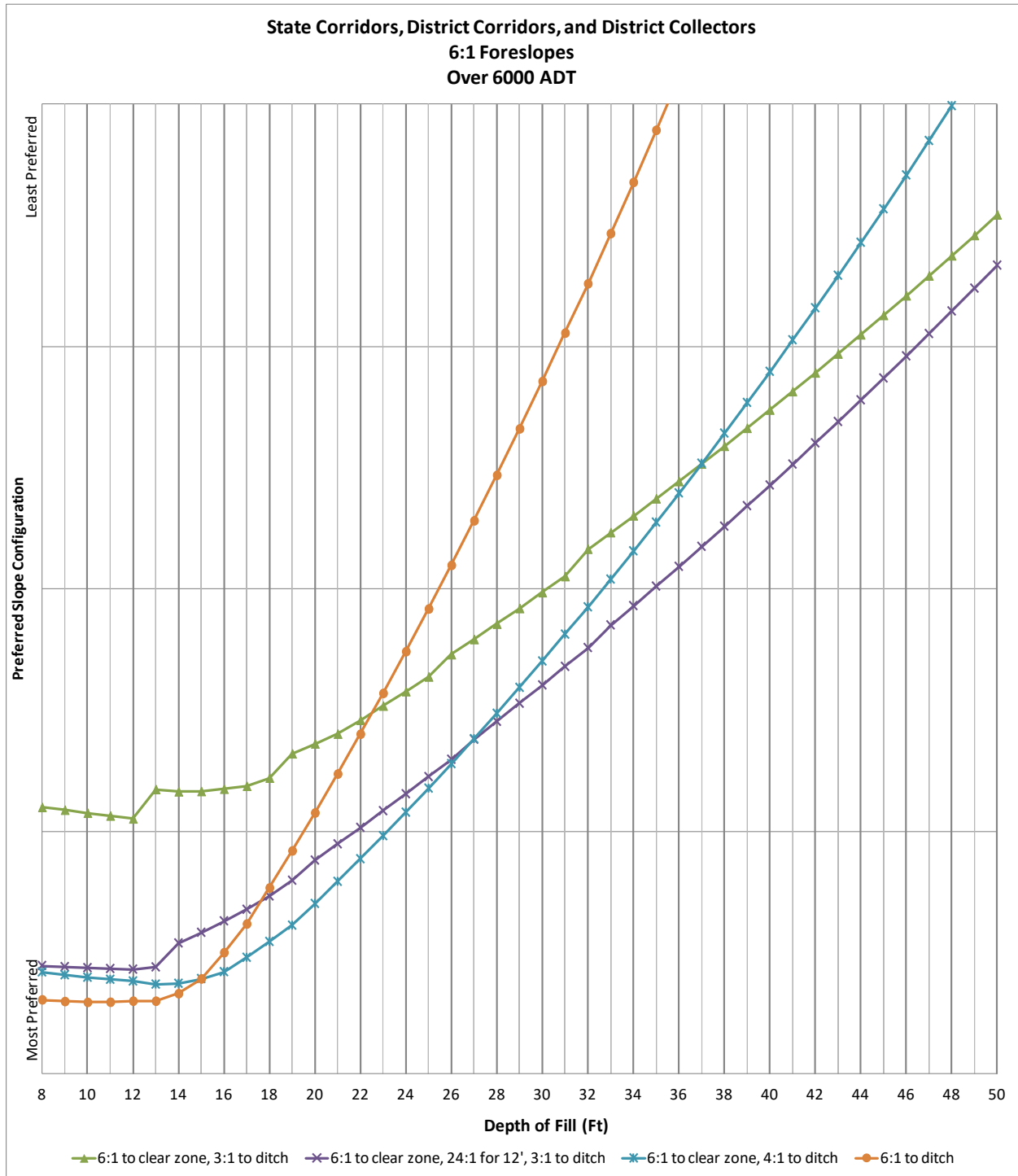
**Figure 9 – 6:1 Foreslopes (Less than 750 ADT)**



**Figure 10 – 6:1 Foreslopes (750 to 1499 ADT)**



**Figure 11 – 6:1 Foreslopes (1500 to 6000 ADT)**



**Figure 12 – 6:1 Foreslopes (Over 6000 ADT)**



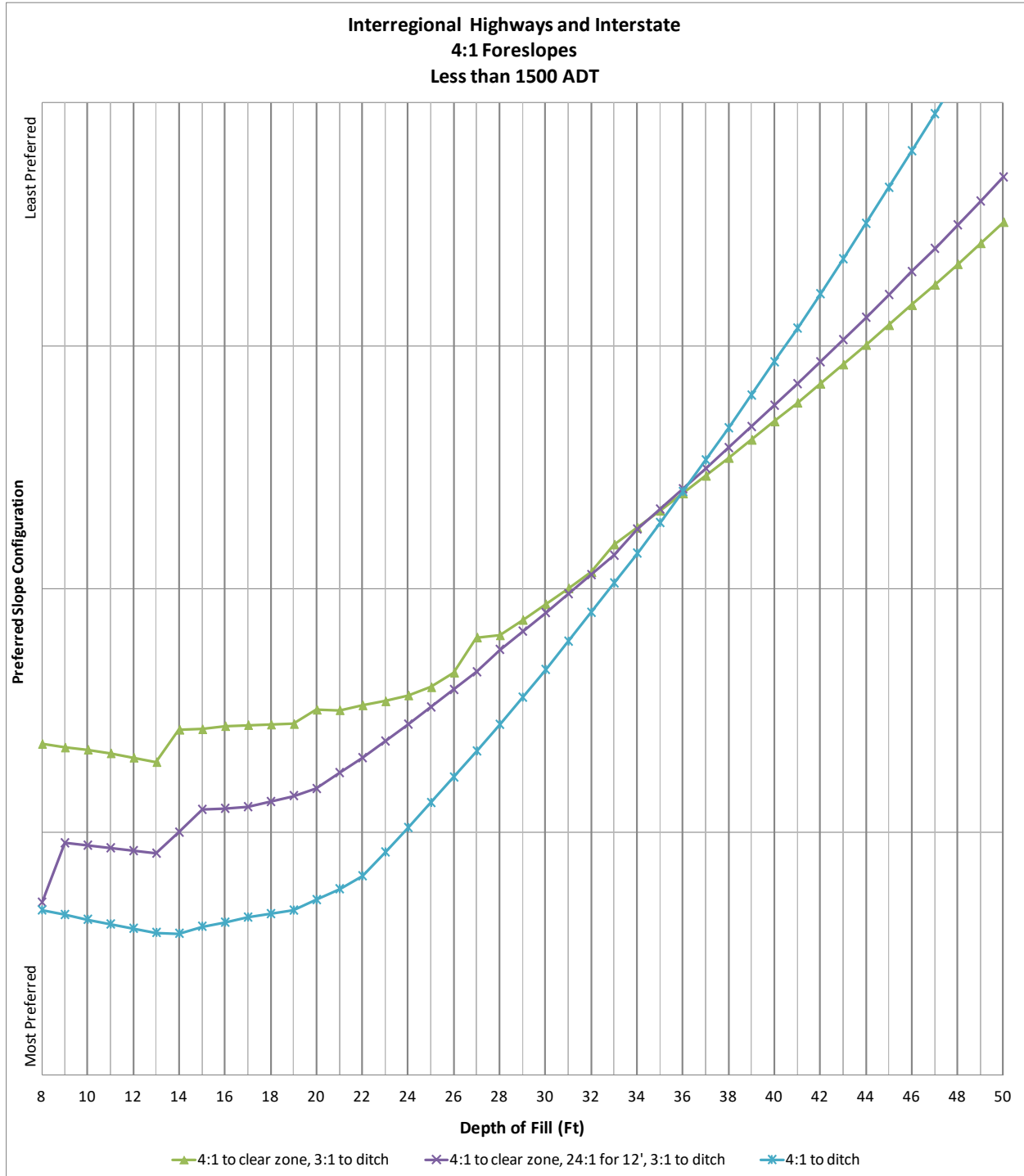
**III-15.06 Interregional Highways and Interstate**

This section addresses highways that are classified as either Interregional or Interstate highways. See Section III-15.05 for highways that are classified as a State Corridor, District Corridor, or District Collector.

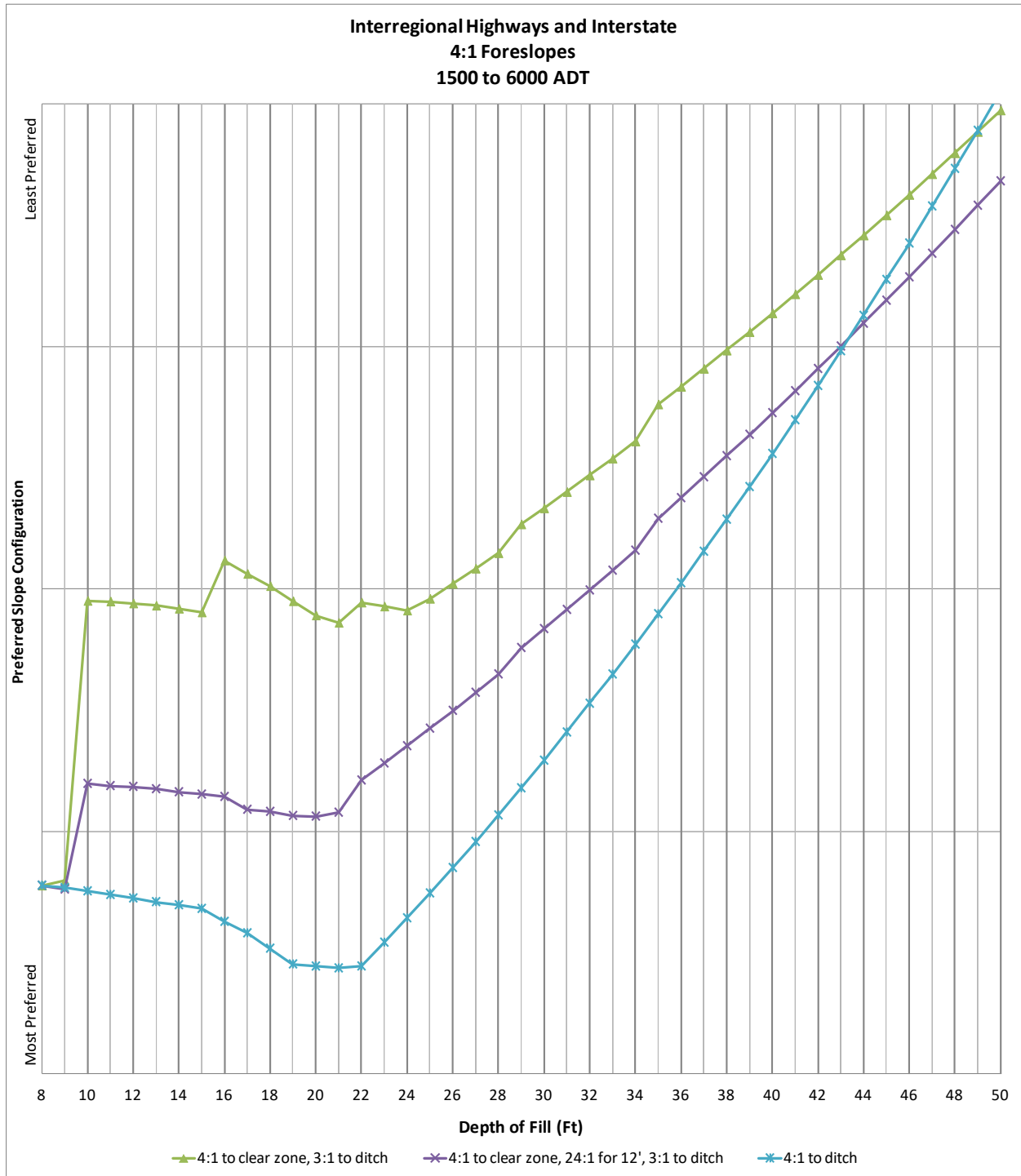
The proposed foreslope configuration should be chosen based on the desirable foreslope rate as shown in the Design Guidelines (Section I-06.03 of the Design Manual.) Figures 13-15 show foreslope configurations for a 4:1 foreslope rate and Figures 16-18 show foreslope configurations for a 6:1 foreslope rate.

Foreslopes flatter than those shown in the Design Guidelines may be used in some cases as described in Section III-14.04 – Standard Foreslope vs. Flattened Foreslope.

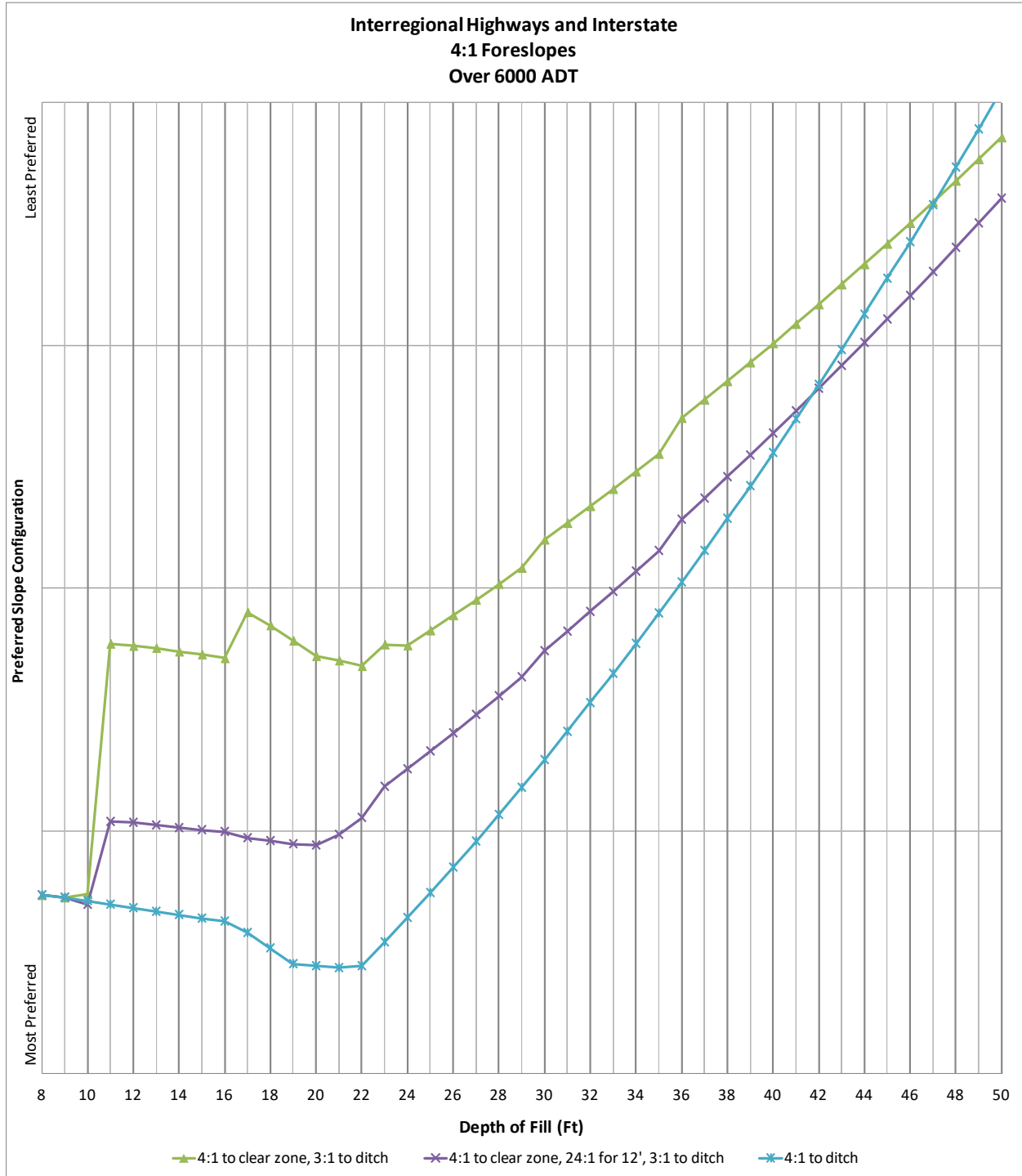
## **4:1 Foreslope Configurations**



**Figure 13 – 4:1 Foreslopes (Less than 1500 ADT)**

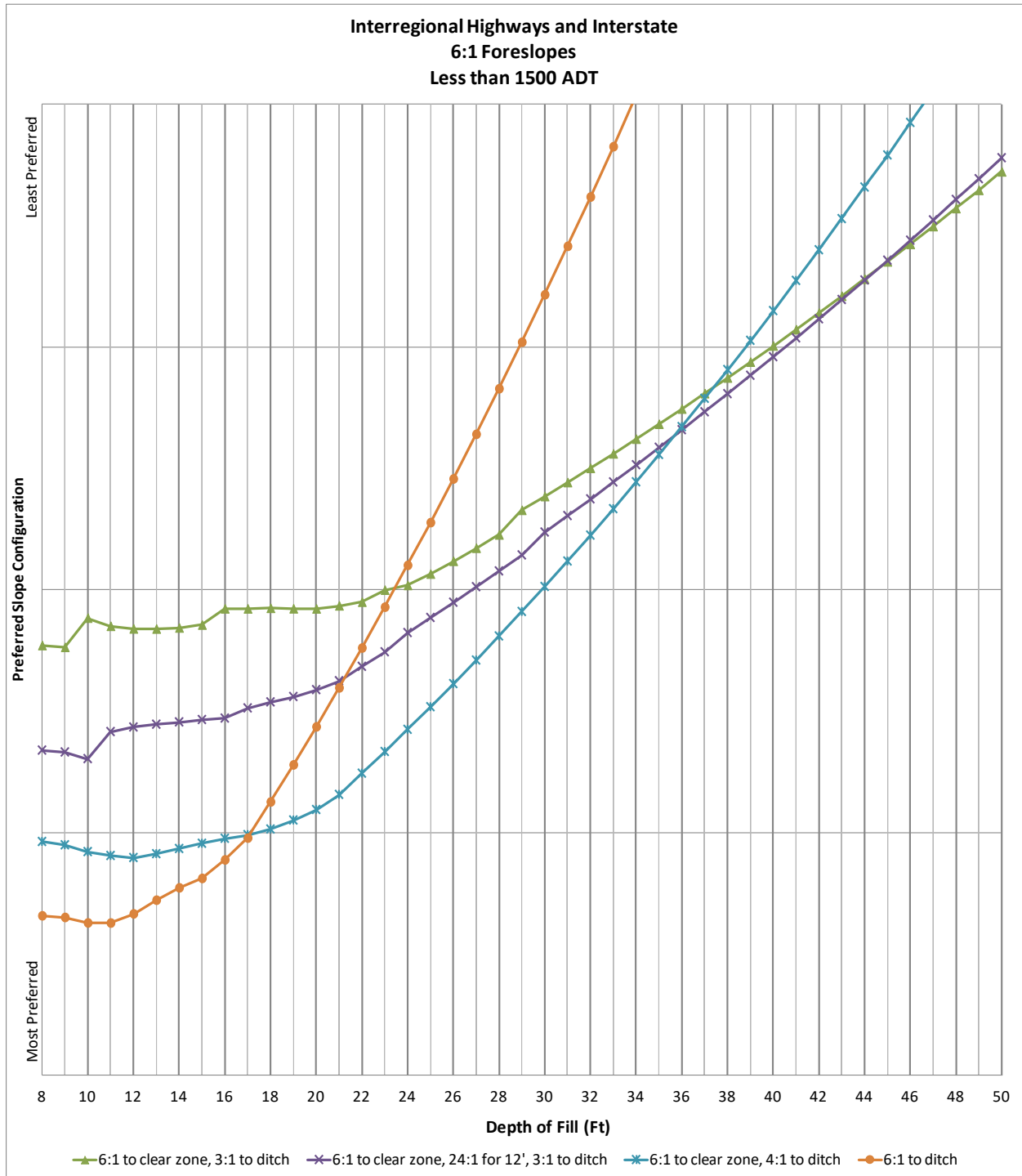


**Figure 14 – 4:1 Foreslopes (1500 to 6000 ADT)**

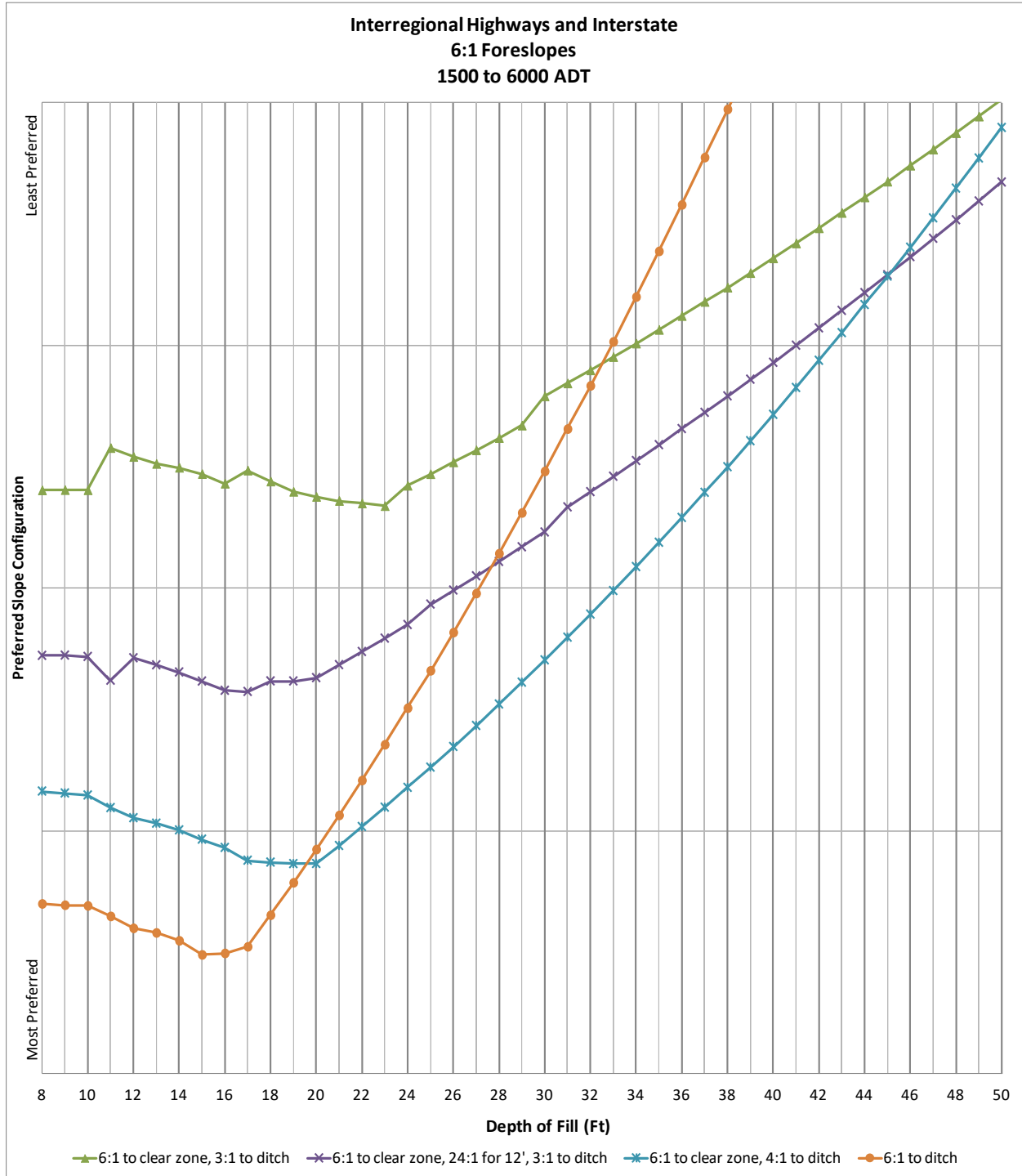


**Figure 15 – 4:1 Foreslopes (Over 6000 ADT)**

## **6:1 Foreslope Configurations**

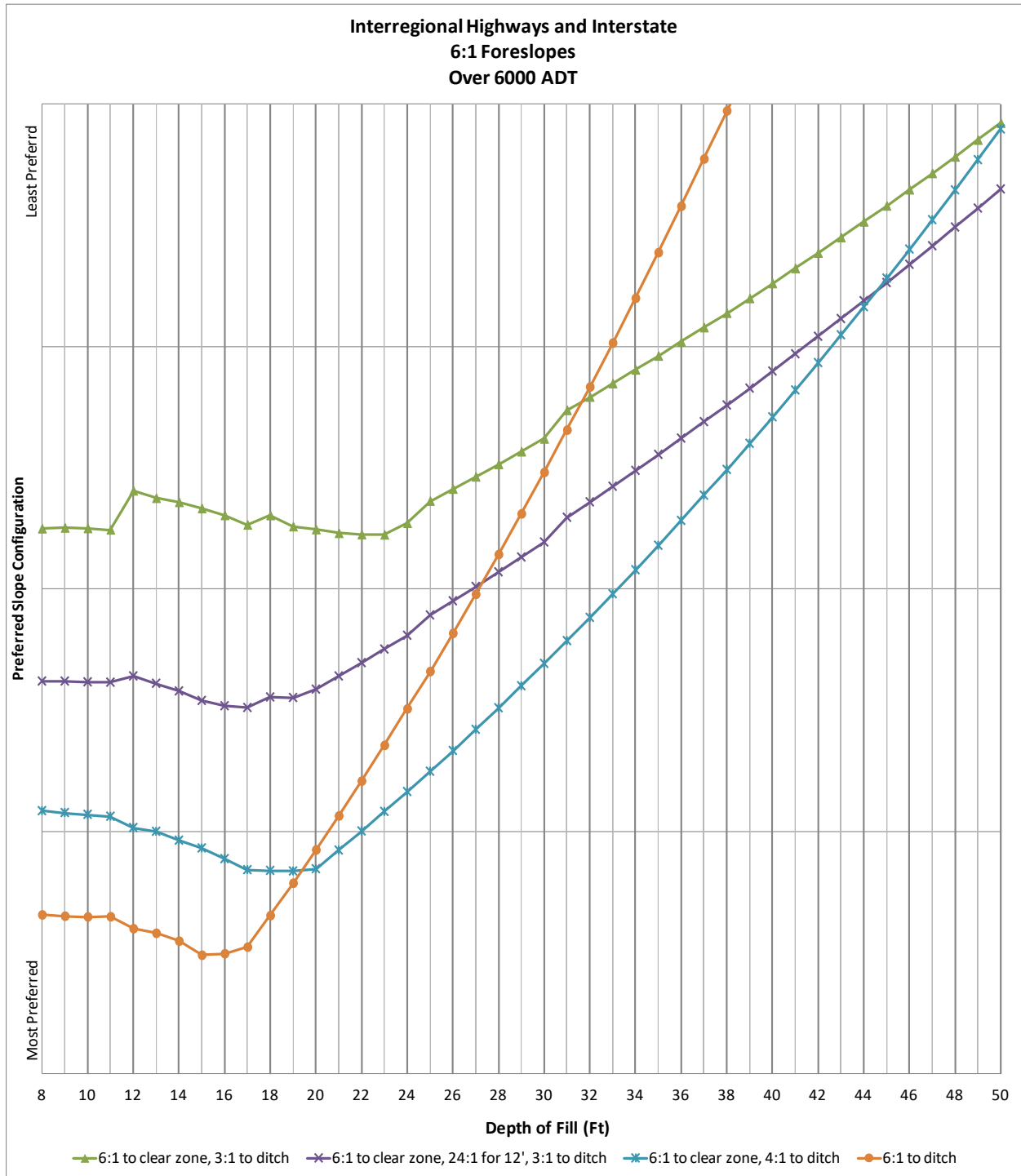


**Figure 16 – 6:1 Foreslopes (Less than 1500 ADT)**



**Figure 17 – 6:1 Foreslopes (1500 to 6000 ADT)**





**Figure 18 – 6:1 Foreslopes (Over 6000 ADT)**

### III-15.07 Examples

#### III-15.07.01 Example 1 – Foreslope Transition at Slide Area

Roadway:	Two-Lane Interregional with 4:1 foreslopes
Design ADT:	3500
Design Speed:	65 MPH
Runout Length (Section III-13):	425 ft
Clear Zone for 4:1 foreslope (Section III-14B):	42 ft
Clear Zone for 6:1 foreslope (Section III-14B):	32 ft

There is a slide area within the clear zone. Based on the Design Guidelines the standard foreslope rate for this roadway is 6:1. Because the project is limited to the area of the slide, a foreslope transition will be needed to tie the existing 4:1 foreslopes into the 6:1 foreslopes in the slide area. Refer to Figure 19 for a plan view of the area and cross sections for this example.

Determine which foreslope configuration will be used through the fill area. To do this, find the deepest fill height measured from the toe of the foreslope at the tie in with the ditch bottom to the edge of the finished shoulder. Because the roadway is a two-lane interregional roadway and the design ADT is 3500, Figure 17 will be used. Using the deepest fill height, choose the best possible foreslope configuration. The most preferred foreslope configuration will be the bottom line. For example, for a fill height of 14', the foreslope configurations in order of preference would be: 1) 6:1 to ditch bottom; 2) 6:1 to clear zone, 4:1 to ditch bottom; 3) 6:1 to clear zone, 24:1 for 12', 3:1 to ditch bottom; and 4) 6:1 to clear zone, 3:1 to ditch bottom. The same foreslope configuration should be used throughout the fill section. The most preferred foreslope configuration should be used unless site conditions do not allow it.

Once the foreslope configuration has been determined, the limits of the fill area can be found (Section D-D.) Sometimes it may not be clear where the fill area begins and ends and may require engineering judgment to determine the limits and/or trial and error to find the best place to fit the foreslope transition.

A 25' transition should be used to transition between Section C-C and Section D-D. A transition will not be needed when the foreslope configuration in Section D-D consists of a 6:1 foreslope that breaks to a 4:1 foreslope at the clear zone.

Determine the point at which the foreslope will begin to transition from a 4:1 foreslope to a 6:1 foreslope. The transition will follow the runout path and begin at the point where the runout path intersects the edge of the finished shoulder (Section A-A.) The runout path can be determined using the runout length as stated in Section III-15.03 – Foreslope Transitions. The foreslope rate in the transition area (Section B-B) should have the same rate as the foreslope in the fill area (Section D-D.)

The 4:1 foreslope becomes the secondary foreslope at the start of the transition area (Section A-A.) The top of the 4:1 foreslope should be at the edge of the 6:1 foreslope along the runout path and the bottom will be where the 4:1 foreslope ties back into the ditch bottom.

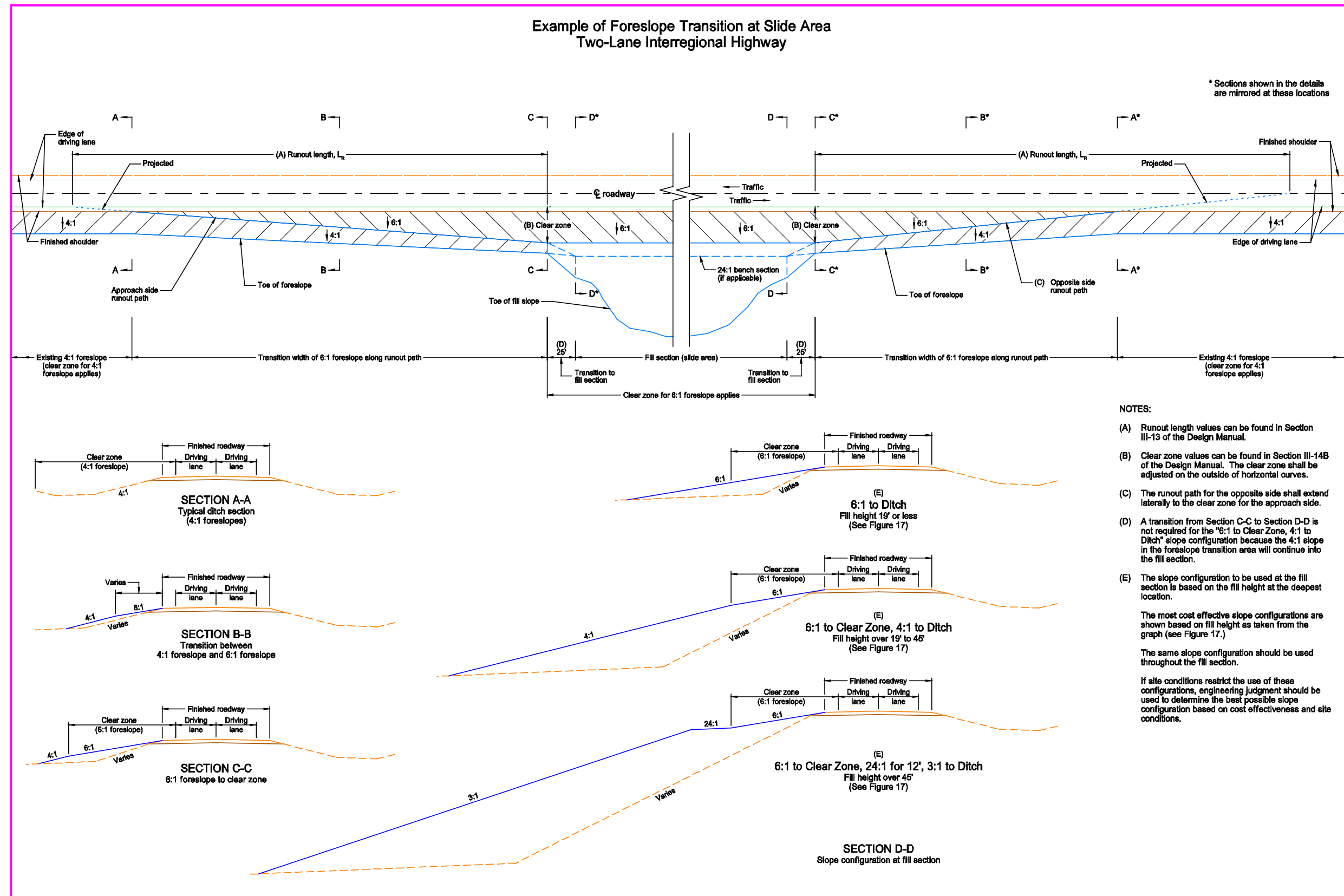


Figure 19 – Example 1 – Foreslope Transition at Slide Area

### III-15.07.02 Example 2 – Foreslope Transition at Box Culvert

Roadway:	Two-Lane District Corridor with 4:1 foreslopes
Design ADT:	1200
Design Speed:	65 MPH
Runout Length (Section III-13):	370 ft
Clear Zone for 4:1 foreslope (Section III-14B):	36 ft
Clear Zone for 6:1 foreslope (Section III-14B):	26 ft

There is a box culvert within the clear zone. Based on the Design Guidelines the standard foreslope rate for this roadway is 4:1. The decision was made to use a foreslope with a rate of 6:1 at the box culvert to reduce the length of the box culvert extension. A foreslope transition will be needed to tie the existing 4:1 foreslopes into the 6:1 foreslopes at the box culvert. Refer to Figure 20 for a plan view of the area and cross sections for this example.

Figure 20 shows two different scenarios:

1. In the first scenario (left side of Section E-E), the box culvert does not have enough cover fill to fit a 6:1 foreslope and the foreslope must be flattened to tie into the box culvert parapet.
2. In the second scenario (right side of Section E-E), there is sufficient cover and no additional flattening over the box culvert is required.

Determine which foreslope configuration will be used through the area with the box culvert. To do this, find the deepest fill height measured from the toe of the foreslope at the tie in with the ditch bottom to the edge of the finished shoulder. Generally, the deepest height will be at the box culvert. Because the roadway is a two-lane district corridor and the design ADT is 1200, Figure 10 will be used. Using the deepest fill height, choose the best possible foreslope configuration. The most preferred foreslope configuration will be the bottom line. For example, for a fill height of 12', the foreslope configurations in order of preference would be: 1) 6:1 to ditch bottom; 2) 6:1 to clear zone, 4:1 to ditch bottom; 3) 6:1 to clear zone, 24:1 for 12', 3:1 to ditch bottom; and 4) 6:1 to clear zone, 3:1 to ditch bottom. The same foreslope configuration should be used throughout the area even though the fill height may change. The most preferred foreslope configuration should be used unless site conditions do not allow it.

Once the foreslope configuration has been determined, the limits of the area to be flattened can be found (Section E-E.) The minimum length of the area to be flattened should be the length of the box culvert opening plus a 25' buffer on each side of the opening. If the box culvert is in an area with a fill over 7' deep, use the limits of the fill area.

A 25' transition should be used to transition between Section D-D and Section E-E. A transition will not be needed when the foreslope configuration in Section E-E consists of a 6:1 foreslope that breaks to a 4:1 foreslope at the clear zone.

For shallow box culverts, additional flattening may be required directly over the box culvert. A maximum rate of 10:1 (perpendicular to foreslope) should be used between the 6:1 foreslope and the flattened area over the box culvert. The 10:1 slope may overlap the 25' transition between Section D-D and Section E-E.

Determine the point at which the foreslope will begin to transition from a 4:1 foreslope to a 6:1 foreslope. The transition will follow the runout path and begin at the point where the runout path intersects the edge of the finished shoulder (Section A-A on upstream end for approach side traffic and Section B-B on downstream end for opposite side traffic.) The runout path can be determined using the runout length as stated in Section III-15.03 – Foreslope Transitions. The foreslope rate in the transition area (Section C-C) should have the same rate as the foreslope in the fill area (Section E-E.)

The 4:1 foreslope becomes the secondary foreslope at the start of the transition area (Section A-A.) The top of the 4:1 foreslope should be at the edge of the 6:1 foreslope along the runout path and the bottom will be where the 4:1 foreslope ties back into the ditch bottom.

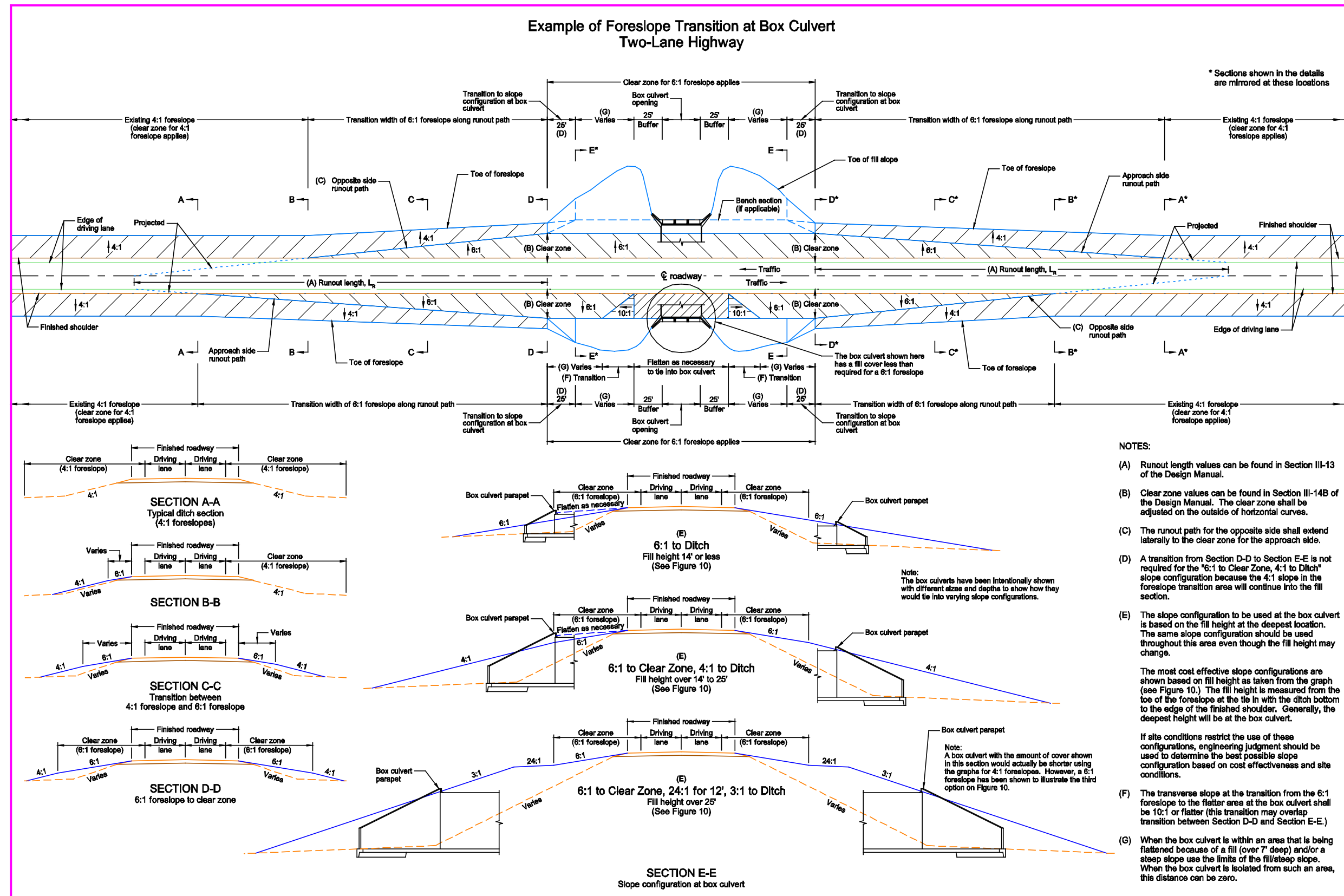


Figure 20 – Example 2 – Foreslope Transition at Box Culvert

**III-15.07.03 Example 3 – Grade Raise with Water on One Side Only**

Roadway: Two-Lane State Corridor with 4:1 foreslopes  
Design ADT: 1000  
Design Speed: 65 MPH  
Runout Length (Section III-13): 370 ft  
Clear Zone for 4:1 foreslope (Section III-14B): 36 ft  
Clear Zone for 10:1 foreslope (Section III-14B): 24 ft

There is water over 2' deep within the clear zone on one side of the roadway. Based on the Design Guidelines the standard foreslope rate for this roadway is 4:1. Because of the proximity of the water to the roadway, the decision was made to do a grade raise project. Refer to Figure 21 for a plan view of the area and cross sections for this example.

**Water Side**

Typically, a grade raise has a 10:1 foreslope to the clear zone followed by riprap and a 3:1 slope. See the Earthwork section of the Design Manual for more information on Grade Raises. A foreslope transition will be needed to tie the existing 4:1 foreslopes into the 10:1 foreslopes at the grade raise.

Determine the limits of the fill section area (Section D-D.) Sometimes it may not be clear where the fill area begins and ends and may require engineering judgment to determine the limits and/or trial and error to find the best place to fit the foreslope transition.

A 25' transition should be used to transition between Section C-C and Section D-D.

Determine the point at which the foreslope will begin to transition from a 4:1 foreslope to a 10:1 foreslope. The transition will follow the runout path and begin at the point where the runout path intersects the edge of the finished shoulder (Section A-A.) The runout path can be determined using the runout length as stated in Section III-15.03 – Foreslope Transitions. The foreslope rate in the transition area (Section B-B) should have the same rate as the foreslope in the fill area (Section D-D.)

The 4:1 foreslope becomes the secondary foreslope at the start of the transition area (Section A-A.) The top of the 4:1 foreslope should be at the edge of the 10:1 foreslope along the runout path and the bottom will be where the 4:1 foreslope ties back into the ditch bottom.

**Dry Side**

Determine which foreslope configuration will be used through the fill area on the dry side. To do this, find the deepest fill height measured from the toe of the foreslope at the tie in with the ditch bottom to the edge of the finished shoulder. Because the roadway is a two-lane state corridor and the design ADT is 1000, Figure 6 will be used. Using the deepest fill height, choose the best possible foreslope configuration. The most preferred foreslope configuration will be the bottom line. For example, for a fill height of 18', the foreslope configurations in order of preference would be: 1) 4:1 to ditch bottom; 2) 4:1 to clear zone, 24:1 for 12', 3:1 to ditch bottom; and 3) 4:1 to clear zone, 3:1 to ditch bottom. The same foreslope configuration should be used throughout the fill section. The most preferred foreslope configuration should be used unless site conditions do not allow it.

Once the foreslope configuration has been determined, the limits of the fill area can be found (Section D-D.) Sometimes it may not be clear where the fill area begins and ends and may require engineering judgment to determine the limits and/or trial and error to find the best place to fit the foreslope transition.

A 25' transition should be used to transition between Section C-C and Section D-D. The transition ties the existing 4:1 foreslope at Section C-C with the slope configuration in the fill section at Section D-D.

A foreslope transition using the runout length is not needed on the dry side because the existing foreslope and the foreslope in the fill section both have the same slope rate.



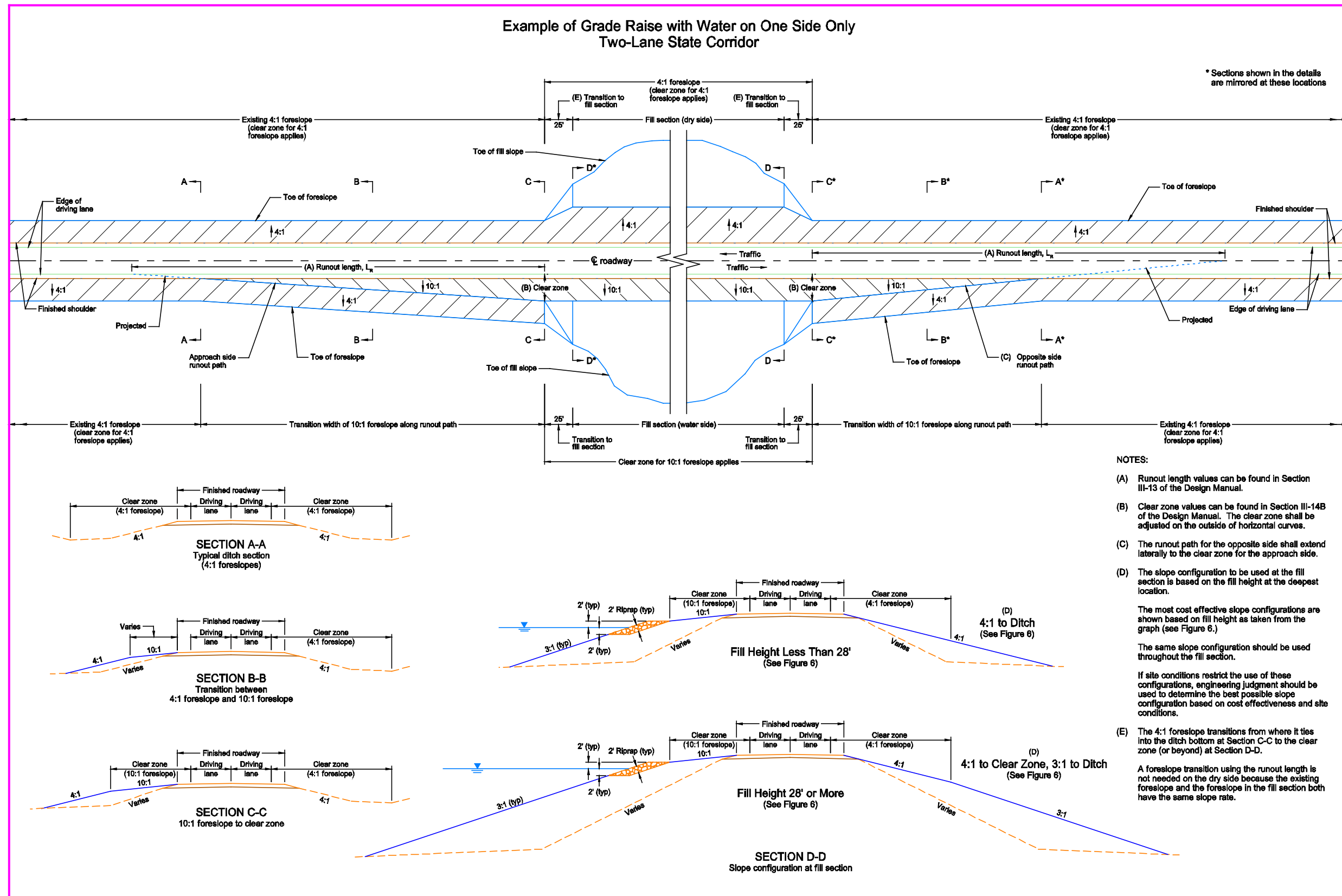


Figure 21 – Example 3 – Grade Raise with Water on One Side Only

*A POLICY* states, “Access management involves providing (or managing) access to land development while simultaneously preserving the flow of traffic on the surrounding road system in terms of safety, capacity, and speed.” See *A POLICY* for more discussion on Access Management.

The access controls in use are either Full, such as exists on the Interstate system where access is gained only at interchanges, or Partial, where access is limited to certain locations on the system. In either case, if this type of control is desired it will have to be negotiated as permanent R/W.

### **III-16.01 Partially Controlled Access – Rural Areas**

The planning and design of projects in rural areas on state highways should, where possible, consider partial access control to provide for the safe and efficient flow of traffic and to preserve the public investment.

Generally, the following procedures should be used in the control of access:

- See Standard Drawings D-203-6 and D-203-8 for design details for rural roadways
- Following a field inspection and reviewing with the District Engineer, NDDOT will include recommendations on access control in the environmental document.
- The basic guidelines for establishing access points are based on a maximum of five (5) per side per mile, including section lines.
- A minimum spacing of 500 feet between access points is desirable.
- Access points may or may not be installed during new construction.
- The amount paid for access control will be based on the maximum number of access points allowed.
- The Design Engineer will be responsible for planning access control. This will include the Programming Division and District Engineers.
- Access control will normally be acquired as a property right in a right of way acquisition process.
- Requests for additional access points or changes in the size will be made to the District Engineer and this information is forwarded to the Design Division, who will in turn requests approval from FHWA and record any changes or additions. Things to consider in granting additional access points should include, but are not limited to:
  - Ensuring that traffic safety and capacity will not be impaired or adversely affected.
  - Recapturing public funds when other than a nominal amount has been provided for access control.

### III-16.02 Partially Controlled Access – Urban Areas

Where a major construction project is planned on a state system route involving a Regional highway, NDDOT should consider partial access control to provide for the safe and efficient flow of traffic and to preserve the public investment.

Generally, the following procedures should be used in access control:

- See Standard Drawings D-750-1 and D-750-1A for design details for urban roadways.
- The throat width for urban drives should generally be as follows:
  - 10-15 feet for private residences
  - 20-30 feet for commercial
  - 40 feet for industrial
- Following a field review and discussion with the District Engineer and the local representatives, NDDOT will study the use of partial access control and publish the results in the environmental document.
- The minimum desirable spacing of access points is 400-600 feet or at the intersection with streets.
- The actual location of the specific access points will be a joint effort between the Design Division, District, Programming, and representatives of the local agency.
- Control of access can be achieved by an agreement between the local agency and NDDOT or by the acquisition of access rights by either or both parties. The local agency must adopt the plan designating the points of access.
- Changes in the size, location or number of access points will not be permitted without mutual consent of the parties, including FHWA where appropriate.

Notice of Proposed Construction or Alteration:

- A. Any proposed construction of more than 200 feet in height above the ground requires a notice be sent to the Federal Aviation Administrator (FAA).
- B. Any proposed construction that enters an imaginary line that extends from a point 200 feet from the end of the nearest airport runway, upward and outward at one of the following slopes:
  - 1. 100:1 for a horizontal distance of 20,000 feet with the length of runway more than 3200 feet.
  - 2. 50:1 for a horizontal distance of 10,000 feet with a length of runway not more than 3200 feet.
  - 3. 25:1 for a horizontal distance of 5,000 feet from the nearest point of a heliport.
- C. FAA: See Form 7460-1: Notice of Proposed Construction or Alteration on the web at <http://www.faa.gov> under forms. This form should be completed if any of the conditions in B are encountered during the design of the project. This form may be obtained from the Airport Engineer, 2000 University Drive, Bismarck, ND (Phone 701-250-4385).
- D. Study the form carefully because attachments are required. One attachment is the source of coordinate's information, USGS 7.5' Quad Map or Survey, and the reference datum, NAD 27 or NAD 83. The other attachment is the Surveyor's certification.
- E. The proposed installation of street lighting becomes more complex to the project. Each street light must have the coordinates, height of structure and ground line elevations listed. This may be done on a separate sheet.
- F. North Dakota is located in the Great Lakes Region of the FAA offices.
- G. Approval by the Federal Aviation Administration is required before the construction within any airport zone may begin. The approval can be expected to take 2 to 6 months from the date notice is received.

The Utilities Engineer from the Design Division – Technical Support Section will coordinate the survey and prepare the Notice of Proposed Construction or Alteration form. The designer should begin coordinating with the Utilities Engineer after the environmental document approval, and on an on-going basis as the preliminary roadway design becomes available.

### **III-18.01 General**

One of the critical parts of the design of highway construction projects is ensuring that effective provisions for proper control of traffic within the construction work zone is provided for on the project. Highway construction generally results in heavy equipment working in close proximity to highway traffic, many times with restricted roadway widths, alignment shifts, and/or temporary driving surfaces. These conditions not only have a direct impact upon public safety, but also present a significant hazard to contractor equipment and personnel working on the project. It is vital that every construction project have an appropriate traffic control plan that will properly guide traffic through the work zone, at appropriate travel speeds, in both daytime and nighttime periods, for the duration of the construction activity. In addition, if there are pedestrians in the project area, the plans must provide for their safe passage through the project. Access to adjacent properties is also an important consideration that must be provided for in the traffic control plan. The work zone traffic control for a project should be planned early in the design phase. Final work zone traffic control plans should be reviewed by the Design Division – Traffic Safety Section.

This section reviews applicable policies and procedures governing work zone traffic control and the resources available for use in the design process.

### **III-18.02 Design of Work Zone Traffic Control**

Design of work zone traffic control should comply with the requirements of the “Manual on Uniform Traffic Control Devices” (MUTCD), Part VI, published by FHWA, and comply with NDDOT Standard Drawings.

### **III-18.03 Work Zone Traffic Control Plan**

A work zone traffic control plan should be prepared for all projects, as no single set of signs or other traffic control devices can satisfy all conditions on a project. The traffic control plan should be in sufficient detail, appropriate to the complexity of the project, to clearly identify and convey the concepts of project traffic control and the types of traffic control devices necessary to achieve the desired control. The selection of traffic control devices should be based on the highway type, traffic conditions, duration of operations, physical constraints, and the proximity of the work area to the highway traffic.

The traffic control plan may range in scope from simply identifying Standard Drawings and layouts, to preparing extensive detailed project specific plan drawings and notes. The Standard Drawings show typical applications and layouts for traffic control devices for various common work situations, but do not include all conceivable work situations, especially those with complicated signing or other traffic control needs.

Typical applications shown by the Standard Drawings should be altered, when necessary, to fit the conditions of the proposed work situation. Detail drawings and plan notes may be required to clarify device locations and quantities. The designer should review the Standard Drawings and Standard Notes to determine what drawings, layouts, and notes may apply to the proposed project. If special conditions exist that cannot be conveyed by the Standard Drawings and Standard Notes, or the Standard Drawings require modification, additional plan drawings or details and notes should be developed to indicate the necessary traffic control requirements. Project notes should identify the necessary Standard Drawings, application, and other special conditions. On complex projects, the work zone traffic control details and quantities should be developed for all construction phases anticipated on the project.

The traffic control plan should include a "Traffic Control Devices List", indicating the quantities for each type of traffic control device required. The "Traffic Control Devices List" should be included in the plans for every project. The quantities should be developed from the Standard Drawings and other work zone details that may be included. The signing indicated should be applied in both directions for two-lane and four-lane roadways, and be applied to both sides of the roadway for freeway and expressway projects. The plans should address quantities for multiple installations, intersections, limitations, etc. The quantities shown on the "Traffic Control Devices List" are for bidding purposes. The "Traffic Control Devices List" program can be found on the web at <http://www.dot.nd.gov/manuals/design/designmanual/designmanual.htm>, click on "Plan Preparation Guide", "Plan Sheets", "Section 700", "704.2 Traffic Control Devices List", or on the web at <http://www.dot.nd.gov/>, click on "Publications", "Design Manual", "Plan Prep. Guide", "Plan Sheets", "Section 700", "704.2 Traffic Control Devices List."

It is preferred that traffic control devices be bid and paid for on the basis of unit prices for each type of device shown on the Traffic Control Devices List in accordance with Sections 704.04A and 704.05A of the Standard Specifications. This method of payment is preferred over lump sum payment for the following reasons:

- It provides for a more complete set of plans and better defines the traffic control work item.
- It provides for a method to account for project variations that develop during construction.
- It provides for contract bid prices that may be used as a basis for negotiation when adding traffic control devices.

When using unit payment, devices required in addition to the quantities provided on the Traffic Control Devices List should be added at the unit prices in the contract. If the added devices do not have a contract unit price, then payment should be negotiated or be paid at the prices listed in the "Rental Rates for Equipment and Traffic Control Devices," provided by Construction Services.

Traffic control devices may be bid and paid for on a lump sum basis if the traffic control plan provides fixed quantities, is clearly defined, and requires a single set-up without modification. When using lump sum payment, the following should be added to the traffic control plan note: *The devices listed on the Traffic Control Devices List shall not be bid separately, but shall be included in the lump sum price bid for @Traffic Control@.* When using lump sum payment, devices required in addition to the quantities provided on the Traffic Control Devices List should be added and paid for in accordance with Section 704.05B of the Standard Specifications.

Devices added to accommodate the Contractor's operation are the Contractor's responsibility.

#### III-18.04 Traffic Control Devices List

The "Traffic Control Devices List" program can be found on the web at <http://www.dot.nd.gov/manuals/design/designmanual/designmanual.htm>, click on "Plan Preparation Guide", "Plan Sheets", "Section 700", "704.2 Traffic Control Devices List", or on the web at <http://www.dot.nd.gov/>, click on "Publications", "Design Manual", "Plan Prep. Guide", "Plan Sheets", "Section 700", "704.2 Traffic Control Devices List." The plan sheet table contains all signs and other devices shown in the Standard Drawings. The program file may be copied to the appropriate project file, and the sheet summary edited as necessary to add or delete traffic control devices.

#### III-18.05 Special Signs

Occasionally, signs will be needed that are not provided in the Standard Drawings. These signs may be special detour signs, distance and destination signs, etc. The designer should contact the Design Division – Traffic Safety Section for the proper sign legend, dimensions, and post configuration. The designer should time the request to provide a minimum two week lead time for the Traffic Section.

#### III-18.06 Computation of Sign Units

##### Material Costs Per Project

Signs	\$4.00/ S.F.
Posts	\$10.00 ea.

##### Install Sign and Post(s):

Sign and 1 post	\$22.00
Sign and 2 post	\$36.00
Sign and 3 post	\$48.00
Sign and 4 post	\$60.00

Install sign on existing installed post(s):

Sign and 1 post	\$14.00
Sign and 2 post	\$22.00
Sign and 3 post	\$28.00
Sign and 4 post	\$32.00

Installation costs include hardware, removal, maintenance, profit and overhead.

Units = (Cost of material and installation) :- \$3.50

#### EXAMPLES

Sign mounted on post(s)	Sign mounted on existing installed post(s)
<u>48" x 48" sign and 2 posts</u>	21' x 15" Arrow sign
4' x 4' = 16 sq. ft. x \$4 = \$64.00	1.75' x 1.25' = 2.2 sq. ft. x \$4 = \$ 8.75
2 posts x \$10 = \$20.00	1 post = \$14.00
Install sign and 2 posts = <u>\$36.00</u>	Total = \$22.75
Total \$120.00	
Units = \$120/ 3.50 = 34.3    Use 35	Units = \$22.75/ 3.50 = 6.5    Use 7

NOTE: All units are rounded up to the next even number. Most signs 30 inch in length have units calculated using 1 post and sign over 30 inches to 60 inches in length have units calculated using 2 post. Sign over 60 inches to 96 inches in length have units calculated using 3 posts. Sign over 96 inches in length should have 4 posts but the 4<sup>th</sup> post must be outside 8 feet from the first post.

#### III-18.07 Guidelines for Using Standard Drawings for Construction Signing

Table III-19-1, at the end of this section, has been developed to summarize the application of Standard Drawings for work zone traffic control signing. The table is intended to serve as a guide only, and is not all inclusive. The designer should select the appropriate standard drawings and include them in the project plans. In instances where the standard drawings do not adequately cover the specific type of work proposed, the designer should consult with the Design Division – Traffic Safety Section for assistance in developing appropriate project traffic control.



### III-18.08 Traffic Control Supervisor

Some major projects, with extensive traffic control, high traffic volumes, and/or complicated construction, may warrant the use of a Traffic Control Supervisor. Guidelines for the use of the project Traffic Control Supervisor are as follows:

The Traffic Control Supervisor should be used only on projects that meet one or more of the requirements listed below.

- Projects that include complex construction phasing.
- Projects that have traffic volumes over 750 ADT in rural areas and over 2000 ADT in urban areas.
- Projects that have traffic control devices proposed to cost over \$50,000.
- Projects listed above must have live traffic traveling through the construction area.

The designer should use the above guidelines to determine if a Traffic Control Supervisor is to be recommended. The District Engineer should review the recommendation and make the decision. The guidelines should be adhered to unless special circumstances require the use of a Traffic Control Supervisor.

Standard Note 704-016, as follows, should be included in the plans when the District Engineer determines the Traffic Control Supervisor is required. A plan note further detailing the Traffic Control Supervisor may also be included in the plans.

704-016      TRAFFIC CONTROL SUPERVISOR: A Traffic Control Supervisor shall be provided on the project.

The standard and plan notes can be found on the web at <http://www.dot.nd.gov/manuals/design/designmanual/designmanual.htm>, click on “Plan Preparation Guide”, “Standard Notes” (and “Plan Notes”), “Section 700”, “704 – Traffic Control.”

### III-18.09 Reflective Sheeting for Work Zone Traffic Control Devices

It is the policy of NDDOT that certain traffic control devices in work zones have Micro-cube Corner Prismatic (Diamond Grade) and Micro-cube Corner Prismatic (Fluorescent Diamond Grade) Sheeting.

Generally, the use of Micro-cube Corner Prismatic (Diamond Grade) and Micro-cube Corner Prismatic (Fluorescent Diamond Grade) wide angle retroreflective sheeting on work zone traffic control signs will improve daytime and nighttime visibility, daytime color, handling characteristics, and long-term durability.

Specifically, all work zone traffic control signs should be constructed of Micro-cube Corner Prismatic (Diamond Grade) for white background signs and Fluorescent Diamond Grade for orange background signs.

This should include all detour signs, black on orange work zone traffic control signs, and all other rigid signs installed to control and direct traffic during construction operations.

Orange and white Type I, II, and III barricades, and orange and white vertical panels should be Micro-cube Corner Prismatic (Diamond Grade) Retroreflective Sheeting.

Sheeting requirements for retroreflective bands on cones and drums should be high intensity material or Micro-cube Corner Prismatic Sheeting.

All construction contracts should include the provisions for Micro-cube Corner Prismatic Sheeting.

### **III-18.10 Work Zone Speed Limits**

NDDOT's Traffic Control Review Team has adopted Work Zone Speed Limit Reduction Procedures. A summary of these procedures follows.

#### **III-18.10.01 Seal Coat Projects**

The speed limit on seal coat projects should be reduced as shown on the Standard Drawings.

#### **III-18.10.02 Interstate, Four-Lane Divided and Two-Lane Highways**

This procedure provides a method for considering engineering factors in selecting a work zone speed limit. It is intended to establish speed zones based on actual conditions.

Based on present guidance in the Manual on Uniform Traffic Control Devices (MUTCD), the procedure starts with speed limits of the work site prior to the beginning of the construction activities.

The procedure is based on consideration of speed limits for the work zones on a site by site basis.

The need for a speed reduction is determined through consideration of a number of factors related to the actual condition in a specific work zone.

Where a work zone speed limit reduction may be appropriate, the recommended procedure indicates the maximum speed limit reduction that should be considered 10 mph. A work zone speed limit reduction of greater than 10 mph is not recommended unless the design speed of the geometric element is more than 10 mph below the normal speed limit.

Reduced speed limits are generally for projects that last at least 24 hours, but there is no constrain to using reduced work zone speed limits for shorter projects.

Reduced work zone speed limits should be used only during specific time periods and only for specific portions of the work zone where the engineering factors identified in the work zone speed limit procedure are present.

**III-18.10.02.01 Work Zone Speed Limit Procedure**

The appropriate speed limit for any highway work zone can be determined from the procedure presented in this section. The procedure is applicable to stationary construction zones, maintenance zones and utility operations; intermittent moving or mobile operations; and continuous moving operations. The recommended procedure has four steps:

Step 1 - Determine the existing speed limit.

Step 2 - Determine the work zone condition that applies.

Step 3 - Determine which factors for the appropriate condition apply to the specific site.

Step 4 - Select the work zone speed limit.

Each step is discussed below. This procedure is illustrated by the flow chart in Figure III-19.01. Table G-1 explains the seven work zone conditions that are addressed in Step 2.

Step 1 - Determine the existing speed limit.

The first step in the procedure is to determine the existing (pre-construction) speed limit for the work zone.

Step 2 - Determine the work zone condition that applies.

The work zone condition is determined by the location of the work activities in relation to the traveled way.

Step 3 - Determine which factors for the appropriate condition apply to the specific site.

The third step in the procedure is to review the conditions that are applicable to the condition that is present in the work zone.

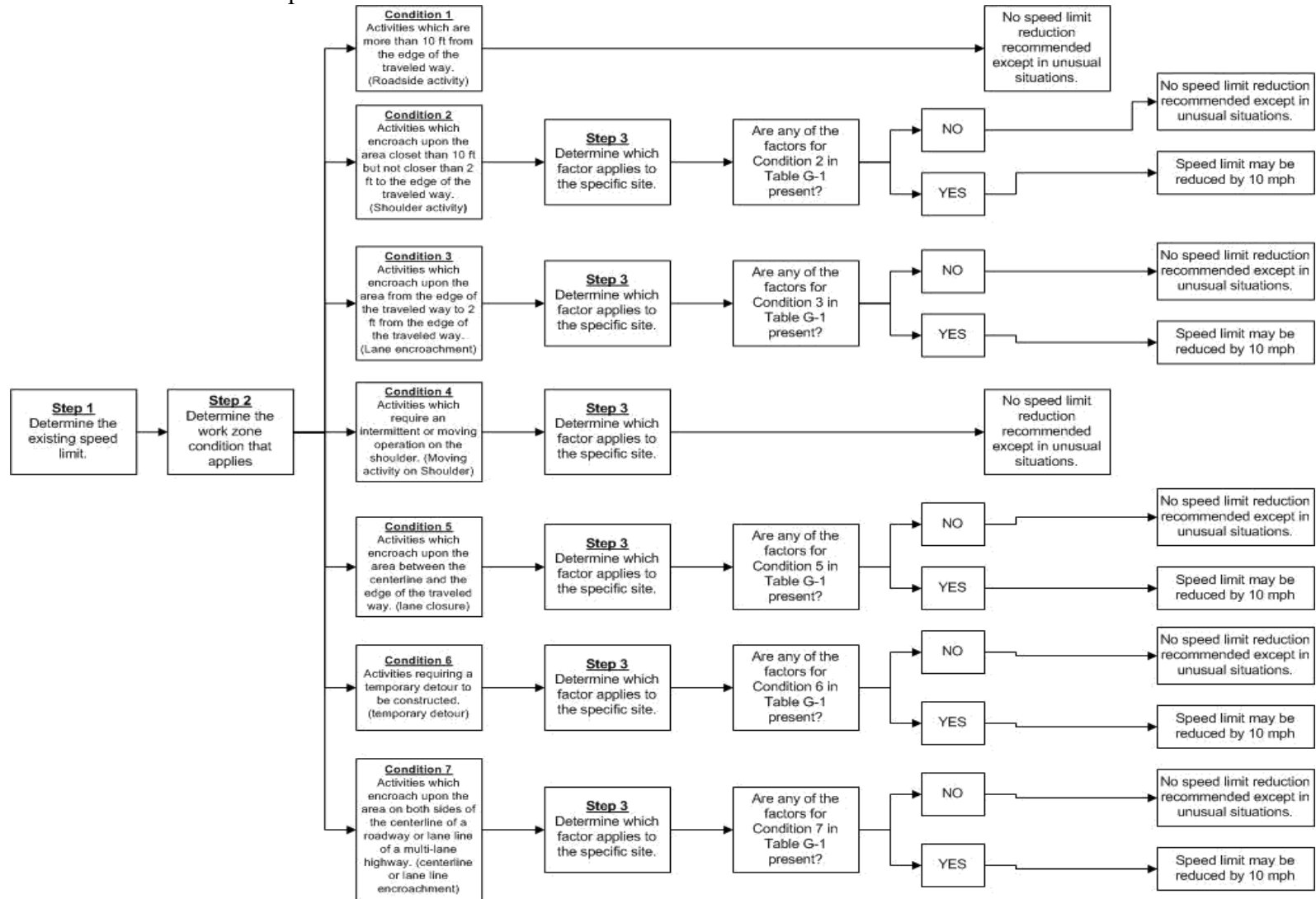
Step 4 - Select the work zone speed limit

The work zone speed limit should be selected considering the factors presented in the conditions.

Project engineers responsible for each work zone should monitor the conditions in the work zone and make sure that the posted speed limit is appropriate for the actual conditions at any given time.

All work zone traffic control should be evaluated at the beginning of the project and periodically through the life of the project to determine if the traffic controls are operating as intended.

Figure III-18.01 – Work Zone Speed Limit Procedure



**TABLE G-1****Condition 1**

Activities that are more than 10 ft from the edge of the traveled way (roadside activity).

**Typical applications**

- Roadway constriction
- Cleaning drainage
- Landscaping work
- Structural work
- Utility work
- Reworking ditches
- Fencing work

**Reduction to Existing Regulatory Speed Limit**

Should not be used.\*

**Suggested Maximum Amount of Speed Reduction**

None

**Factors:**

None

The regulatory speed limit shall meet all requirements of the MUTCD.

\*There should not be a reduction of the existing regulatory speed limit unless unusual situations create hazardous conditions for motorists, pedestrians, or workers.

**Condition 2**

Activities that encroach on the area closer than 10 ft but not closer than 2 ft to the edge of the traveled way (shoulder activity).

**Typical Applications**

- Roadway construction
- Culvert extension
- Guardrail installation
- Cleaning drainage
- Reworking ditches
- Shoulder work
- Utility work
- Side slope work
- Landscaping work
- Structural work
- Sign installation

**Reduction to Existing Regulatory Speed Limit**

May be used where factors exist.

**Suggested Maximum Amount of Speed Reduction**

10 mph

**Factors:**

Workers present for extended periods within 10 ft of the traveled way unprotected by barrier.

Horizontal curvature that might increase vehicle encroachment rate (could include mainline curves, ramps, and turning roadways).

The regulatory speed limit shall meet all requirements of the MUTCD.

**Conditions 3**

Activities that encroach on the area from the edge of the traveled way to 2 ft from the edge of the traveled way (lane encroach).

**Typical Application**

Roadway construction  
Utility work  
Guardrail installation  
Shoulder work

**Reduction to Existing Regulatory Speed Limit**

May be used where factors exist.

**Suggested Maximum Amount of Speed Reduction**

10 mph

**Factors:**

Workers present for extended periods within 2 ft of the traveled way unprotected by barrier.

Horizontal curvature that might increase vehicle encroachment rate (could include mainline curves, ramps, and turning roadways).

Barriers or pavement edge drop-off within 2 ft of the traveled way.

Reduced design speed for stopping sight distance.

Unexpected conditions

The regulatory speed limit shall meet all requirements of the MUTCD. Where work zone geometric with reduced design speeds cannot be avoided, the work zone speed limit should not exceed the design speed, even if this requires a work zone speed limit reduction greater than 10 mph.

**Condition 4**

Activities that require an intermittent or moving operation on the shoulder (moving activity on shoulder).

**Typical Applications**

- Roadway construction
- Widening
- Delineator installation
- Shoulder and slope work
- Utility work
- Guardrail installation
- Landscaping work

**Reduction to Existing Regulatory Speed Limit**

Should not be used.\*

**Suggested Maximum Amount of Speed Reduction**

None

**Factors:**

None

The regulatory speed limit shall meet all requirements of the MUTCD.

\*There should not be a reduction of the existing regulatory speed limit unless unusual situations create hazardous conditions for motorists, pedestrians, or workers.

**Condition 5**

Activities that encroach on the area between the centerline and the edge of traveled way (lane closure).

**Typical Applications**

- Roadway construction
- Pavement repair
- Utility work
- Widening
- Pavement resurfacing
- Pavement marking
- Bridge repair

**Reduction to Existing Regulatory Speed Limit**

May be used where factors exist.

**Suggested Maximum Amount of Speed Reduction**

10 mph

**Factors:**

Workers present for extended periods in the closed lane unprotected by barrier.

Lane width reduction of 1 ft or more with a resulting lane width less than 11 feet.

Traffic control devices encroaching on a lane open to traffic or within a closed lane but within 2 ft of the edge of the open lane.

Reduced design speed for taper length or speed change lane length.

Barriers or pavement edge drop-off within 2 ft of the traveled way.

Reduced design speed of horizontal curve.

Reduced design speed for stopping sight distance.

Traffic congestion created by a lane closure.

Unexpected conditions.

The regulatory speed limit shall meet all requirements of the MUTCD. Where work zone geometric with reduced design speeds cannot be avoided, the work zone speed limit should not exceed the design speed, even if this requires a work zone speed limit reduction greater than 10 mph.



**Condition 6**

Activities require a temporary detour to be constructed (temporary detour).\*\*

**Typical Applications**

- Roadway construction
- Subgrade restoration
- Bridge construction
- Culvert repair

**Reduction to Existing Regulatory Speed Limit**

May be used where factors exist.

**Suggested Maximum Amount of Speed Reduction**

10 mph

**Factors:**

Lane width reduction of 1 ft or more with a resulting lane width less than 11 feet.

Reduced design speed for detour roadway or transition (radius of curvature, superelevation, and sight distance).

Unexpected conditions.

The regulatory speed limit shall meet all requirements of the MUTCD. Where work zone geometric with reduced design speeds cannot be avoided, the work zone speed limit should not exceed the design speed, even if this requires a work zone speed limit reduction greater than 10 mph.

\*\*Detour and transition geometry with a design speed equal to or greater than the existing regulatory speed limit should be provided whenever possible.

**Condition 7**

Activities that encroach on the area on both sides of the centerline of a roadway or lane lines of a multilane highway (centerline or lane line encroachment).

**Typical Applications**

- Roadway construction
- Widening
- Pavement marking
- Crack sealing
- Pavement resurfacing
- Bridge repair
- Pavement repair

**Reduction to Existing Regulatory Speed Limit**

May be used where factors exist.

**Suggested Maximum Amount of Speed Reduction**

10 mph

**Factors:**

Workers present on foot in the traveled way or in the closed lane unprotected by barrier for extended periods.

Remaining lane plus shoulder width is less than 11 ft.

Reduced design speed for taper length or speed change lane length.

Barriers or pavement edge drop-off within 2 ft of the traveled way.

Reduced design speed of horizontal curve.

Reduced design speed for stopping sight distance.

Traffic congestion created by a lane closure.

Unexpected conditions.

The regulatory speed limit shall meet all requirements of the MUTCD. Where work zone geometrics with reduced design speeds cannot be avoided, the work zone speed limit should not exceed the design speed, even if this requires a work zone speed limit reduction greater than 10 mph.

**III-18.11 Longitudinal Edge Drop-off Guidelines**

These guidelines are intended to increase traffic safety by identifying techniques for the treatment of uneven lanes and edge drop-offs that occur along the centerline, edgeline, and shoulders in highway work areas. One of the best ways to increase traffic safety is to minimize exposure to uneven lanes and edge drop-offs. The following guidelines incorporating traffic control devices and construction methods may be applied to enhance traffic safety. See Figure III-19.02, Longitudinal Edge Drop-Off Guidelines, at the end of this section for a graphical representation of these techniques.

GENERAL:

- At no time should there be more than one uneven lane condition between the traffic carrying lanes, which include auxiliary lanes, turn lanes, and ramp access or egress areas. Weather permitting, all exposed uneven lane conditions within the traffic carrying lanes should be matched within 24 hours.
- Traffic control signs, as shown, should be repeated after major intersections. A major intersection is defined as an intersection between a state highway and another state highway, an Interstate ramp, or a County Major Collector (CMC).
- The maximum sign spacing should be 1 mile when the speed limit is greater than 30 mph.
- The maximum sign spacing should be 1/4 mile when the speed limit is 30 mph or less.
- The maximum spacing of channelizing devices used to close the shoulder is 100 feet.
- The maximum spacing of Type III Barricades used to close a lane is 1000 feet.

UNEVEN LANES – PAVING OPERATIONS:

Note: The following paragraph and subparagraph numbers correspond to drawings on Figure III-19.02, which follows this section.

## 1. Two Lane Highways

- A. For drop-offs of 1-1/2 inches or less, appropriate traffic control signs should be provided as indicated in Standard Note 704-250. Traffic can be permitted to cross the drop-off.
- B. For drop-offs of 1-1/2 to 2-1/2 inches, appropriate traffic control signs and devices should be provided as indicated in Standard Note 704-251 for ADT of 750 or less, or Standard Note 704-252 for ADT greater than 750. Traffic should not be permitted to cross the drop-off as shown.
- C. For drop-offs of 2-1/2 to 4 inches, appropriate traffic control signs and devices should be provided as indicated in Standard Note 704-253. Traffic should not be permitted to cross the drop-off.

## 2. Four Lane Divided and Interstate Highways

For drop-offs of 2 inches or less, appropriate traffic control signs and a lane closure should be provided as indicated in Standard Note 704-254. Traffic should not be permitted to cross the drop-off.

### 3. Shoulders – All Highways

For drop-offs of various depths, appropriate traffic control signs and an edge slough should be provided as indicated in Standard Note 704-255. Traffic may cross the drop-off.

#### UNEVEN LANES – MILLING OPERATIONS:

Milling operations should use the guidelines shown for paving operations. The plan notes, etc., will require modifications in terminology for the milling operations.

#### EDGE DROP-OFFS – ADJACENT TO TRAFFIC CARRYING LANE:

1. For drop-offs of 1-1/2 inches or less, appropriate traffic control signs should be provided as shown in Figure III-19.02 at the end of this section.
2. For drop-offs greater than 1-1/2 inches up to 4 inches:
  - A. The edge should be tapered and compacted at a slope of 4:1 and appropriate traffic control signs should be provided; or
  - B. If the taper is not provided, traffic should not be permitted to cross the drop-off, and that portion of the roadway should be closed to traffic with appropriate traffic control signs and devices.
3. For drop-offs greater than 4 inches up to 12 inches:
  - A. The edge should be tapered and compacted at a slope of 4:1. Traffic should not be allowed to cross the drop-off, and that portion of the roadway should be closed to traffic with appropriate traffic control signs and devices; Vertical Panels shall be placed at the top of the slope or Stackable Vertical Panels placed at the edge of the driving lane; or
  - B. If a taper is not provided, the traffic should not be allowed to cross the drop-off, and that portion of the roadway should be closed to traffic with appropriate traffic control signs, devices, and a positive barrier, such as a portable precast concrete barrier; or
  - C. If a taper is not provided, the traffic or auxiliary lane adjacent to the drop-off should be closed to traffic with the appropriate traffic control signs and devices.

Note: Tapers or positive barriers are not required if:

- 1) The drop-off is within an urban area and the speed limit is 30 mph or less; Stackable Vertical Panels placed at the edge of the driving lane; or
- 2) The drop-off is short term (7 calendar days or less) and less than 50 feet in length and the speed limit is higher than 30 mph. Vertical Panels shall be placed at the top of the slope or Stackable Vertical Panels placed at the edge of the driving lane.

4. For drop-offs greater than 12 inches:

The traffic or auxiliary lane adjacent to the drop-off should be closed to traffic with the appropriate traffic control signs and devices, and a positive barrier, such as a portable precast concrete barrier.

Positive barriers are not required if the drop-off is a short term condition (7 calendar days or less) and is located 16 feet or more from the traffic carrying lane.

EDGE DROP-OFFS – INSIDE EDGE OF SHOULDER:

1. For drop-offs of 1-1/2 inches or less, appropriate traffic control signs should be provided.

2. For drop-offs greater than 1-1/2 inches up to 4 inches:

- A. The edge should be tapered and compacted at a slope of 4:1 and appropriate traffic control signs should be provided; or
- B. If the taper is not provided, traffic should not be permitted to cross the drop-off, and that portion of the roadway should be closed to traffic with the appropriate traffic control signs and devices.

3. For drop-offs greater than 4 inches up to 12 inches:

- A. The edge should be tapered and compacted at a slope of 6:1, and appropriate traffic control signs should be provided (6:1 taper should not be used as a traffic carrying lane). This treatment should not be permitted unless the 6:1 slope is compacted so that a vehicle may safely drive onto it without losing control, and there are no other hazardous conditions; Vertical Panels shall be placed at the top of the slope or Stackable Vertical Panels placed at the edge of the driving lane; or
- B. The edge should be tapered and compacted at a slope of 4:1, traffic should not be allowed to cross the drop-off, and that portion of the roadway should be closed to traffic with appropriate traffic control signs and devices; or
- C. If a taper is not provided, the traffic or auxiliary lane adjacent to the drop-off should be closed to traffic with the appropriate traffic control signs and channelizing devices.

4. For drop-offs greater than 12 inches:

The traffic or auxiliary lane adjacent to the drop-off should be closed to traffic with the appropriate traffic control signs and devices, and a positive barrier, such as a portable precast concrete barrier.

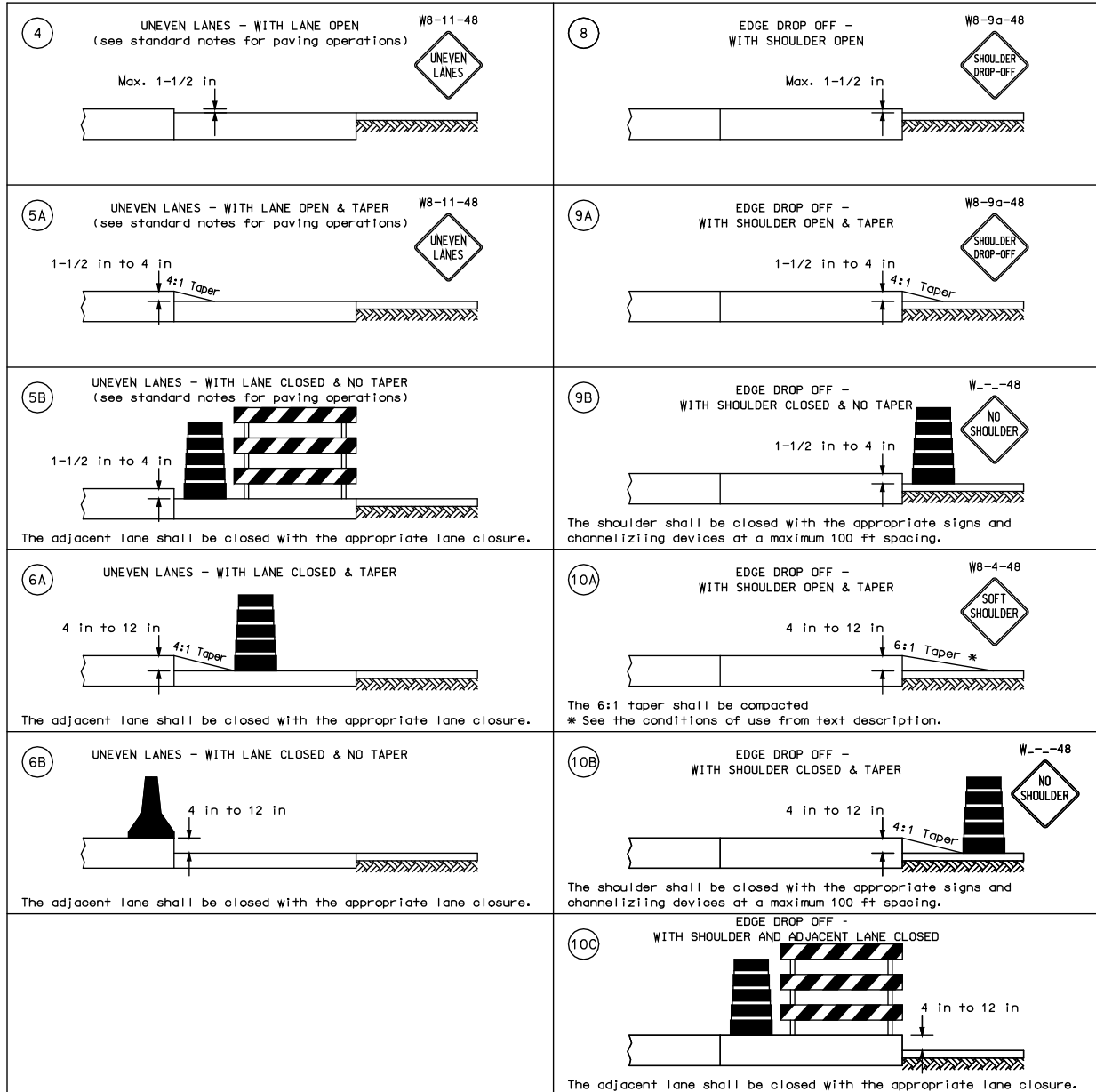
Positive barriers are not required if the drop-off is a short term condition (7 calendar days or less) and located 16 feet or more from the traffic carrying lane.

EDGE DROP-OFFS - OUTSIDE EDGE OF SHOULDER:

1. Shoulder width 0 to 2 feet and a 0 to 12 inch drop-off; use appropriate guideline above. Stackable Vertical Panels placed at the edge of the Shoulder.
2. Shoulder width 2 to 8 feet and a 0 to 4 inch drop-off; install edgeline, or use appropriate guideline above.
3. Shoulder width 8 feet or greater and a 0 to 4 inch drop-off; no traffic control required.
4. Shoulder width 2 to 8 feet and a 4 to 12 inch drop-off; use appropriate guideline above.

Figure III-18.02, which follows, has been developed to summarize longitudinal edge drop-off guidelines for work zones. Vertical Panels shall be placed at the top of the slope or Stackable Vertical Panels placed at the edge of the driving lane. The figure is intended to serve as a guide only and is not all inclusive.

Figure III-18.02 Longitudinal Edge Drop-Off Guidelines



### III-18.12 Warrants for Portable Changeable Message Signs

Portable changeable message signs (PCMS) have a wide variety of applications in work zone traffic control, including roadway or ramp closures, crash or emergency incident management with restrictions information, advisories on road work scheduling, traffic management and diversion, warning of adverse conditions, and operation controls.

The primary purpose of PCMS in work zone traffic control is to advise the driver of unexpected traffic and routing situations. Some typical applications include the following:

- Where speed of traffic is to drop substantially.
- Where queuing and delays are possible.
- Where adverse environmental conditions are present.
- To provide advance notice of ramp, lane, or roadway closure.
- For crash or incident management.

Some typical criteria include:

- The speed limit in the work zone is above 50 mph, and the speed reduction is more than 20 mph.
- When queuing traffic is more than 20 vehicles and delays are greater than 5 minutes.
- Adverse environmental conditions – any chemical spills or other hazardous materials.
- It is assumed that ramp, lane, or roadway closures are normally less than 2 weeks.
- Crash or incidents are hard to quantify.

The designer should use the guidelines to determine if the project meets all of these requirements and then recommends to the District Engineer if the PCMS are to be provided. The District Engineer should consider the recommendation and make the decision. The guidelines should be adhered to unless special circumstances require the use of a PCMS.

A Special Provision covering PCMS has been prepared and should be used on all projects that specify the use of this traffic control device. Contact the Maintenance and Engineering Services Division for the Special Provision.



**Table III-18-1 Traffic Control Devices List**

The “Traffic Control Devices List” program can be found on the web at <http://www.dot.nd.gov/>, click on “Publications”, “Design Manual”, “Plan Prep. Guide”, “Plan Sheets”, “Section 700”, “704.2 Traffic Control Devices List”, or on the web at <http://www.dot.nd.gov/manuals/design/designmanual/designmanual.htm>, click on “Plan Preparation Guide”, “Plan Sheets”, “Section 700”, “704.2 Traffic Control Devices List”. Download XLS, open and follow instructions and the traffic control devices list will provide the quantities for each sign used and a total amount for the bid items. The chart can be printed for plans. The table contains all signs and devices shown in the Standard Drawings. The table may be copied and edited as necessary and unused signs and devices removed to minimize the size of the table.

**Special Signs:**

Occasionally signs will be needed that are not provided in the Standard Drawings. These signs may be special detour signs, distance and destination signs, etc. The designer should contact the Design Division - Traffic Section for the proper sign message, dimensions, and post configuration. The designer should coordinate the request to provide a minimum two week lead time for the Design Division.

TABLE III-18-2 Application of Standard Drawings for Construction Signing

APPLICATION OF STANDARD DRAWINGS FOR CONSTRUCTION SIGNING					
Std Dwg No.	CSL Type	Description	Roadway Type	Duration	Comments
D-704-01	na	Attenuation device	All	na	
D-704-03	na	Lane markers for seal jobs only (spotting tab)	All	na	1) Use on all seal coat projects in accordance to Section 762.04 D.1.e. 2) See example note 762 - P01, to revise method of payment, when short-term pavement markings are not provided. 3) See example note 762 - P01, when using plastic and preformed patterned pavement markings, and it is desired to recess the pavement markings.
D-704-08	na	Breakaway system for construction zone signs	All	na	1) Use on all projects.
D-704-09	na	Construction sign details	All	na	1) Use on all projects.
D-704-10	na	Construction sign details	All	na	1) Use on all projects.
D-704-11	na	Construction sign details	All	na	1) Use on all projects.
D-704-12	na	Construction sign details	All	na	1) Use on all projects.
D-704-13	na	Barricade details	All	na	1) Use on all projects.
D-704-14	na	Construction signs and barricade assembly details	All	na	1) Use on all projects.
D-704-22	K	Truck traffic entering thru highway	All	L,I,S	1) Signs should be covered or taken down at night
D-704-22	L	Truck traffic crossing thru highway	All	L,I,S	1) Signs should be covered or taken down at night
D-704-24	R	Bridge painting below roadway	All	L,I,S	
D-704-24	S	Bridge painting above roadway	All	L,I,S	
D-704-24	T	Work area outside roadway	All	S	1) Use in daylight with good visibility only and outside major work area.
D-704-24	U	Equipment parked on right shoulder	All	S	
D-704-26	Y	Haul road crossing thru highway	All	L,I,S	1) Use when condition exist outside the major work area. 2) Signs should be covered or taken down at night
D-704-26	Z	Speed zone	All	L,I,S	1) Use when condition exist.
D-704-26	AA	Survey crew	All	S	1) Use when condition exist.
D-704-26	BB	Shoulder work or shoulder drop-off	All	L,I,S	1) Use when condition exist within the major work area.
D-704-26	CC	Fresh oil	All	L,I,S	1) Use when condition exist.
D-704-26	DD	Road narrows	All	L,I,S	1) Use when condition exist.
D-704-26	EE	Bump	All	L,I,S	1) Use when condition exist.

APPLICATION OF STANDARD DRAWINGS FOR CONSTRUCTION SIGNING					
Std Dwg No.	CSL Type	Description	Roadway Type	Duration	Comments
D-704-26	FF	End of pavement	All	L,I,S	1) Use when condition exist.
D-704-26	GG	Uneven lanes	All	L,I,S	1) Use when condition exist.
D-704-30	na	Windrow marking	All	L,I,S	1) Use when condition exist.
D-704-42	na	Road construction guide sign	All	L	1) Use on projects that may have a suspension(s) greater than 3 days or through the winter months.
D-704-15	A	Temporary roadway closure with flagger control	2L	SD	1) Use in daylight with good visibility only. The closure should be limited to 15 to 20 minutes only. 2) The layout may be referenced to indicate flagging station layout and signing. 3) Applications include HBP paving operations on two-lane two-way roadways in conjunction with pilot cars, and other operations that require temporary closure of a roadway.
D-704-15	B	Roadway closure with temporary detour (diversion)	2L	L,I	1) Use when condition exist > 1 day or outside major work area. 2) Applications include box culverts and structures. Work areas are typically short in length (<1000 ft). 3) "Sharp" curve signs (W1-3-48 & W13-1-24) should be used on cures with design speeds of 30 mph or less.
D-704-16	na	Lane closure with temporary traffic signal control and barriers	2L	L	1) Use when hazardous conditions exist next to the driving lane and traffic is controlled by signals. Work areas are typically short in length (<1000 ft). Work area geometry should be reviewed for suitability. The signal are typically used on long term projects in-place of flagging. 2) Applications: generally used for structural repair. 3) The contractor should have the option of using this layout or Std. Dwg. D-704-17. Include plan note 704-450 to address the option and method of payment. 4) The attenuation devices and barrier may be deleted by plan note pending engineering analysis. Engineering analysis should include closure time less than 4 weeks.
D-704-17	na	Lane closure with flagger control and barriers	2L	L,I	1) Use when hazardous conditions exist next to the driving lane and traffic is controlled by flagging. 2) Applications include structural repair, pipe installation, excavation, etc. with conditions remaining overnight. Work areas are typically short in length (<1000 ft). 3) For long term projects the contractor should have the option of using this layout or Std. Dwg. D-704-16. Include plan note 704-450 to address the option and method of payment. 4) The attenuation devices and barrier may be deleted by plan note pending engineering analysis. Engineering analysis should

APPLICATION OF STANDARD DRAWINGS FOR CONSTRUCTION SIGNING					
Std Dwg No.	CSL Type	Description	Roadway Type	Duration	Comments
					include closure time less than 4 weeks.
D-704-19	E	Detour signing - roadway closure beyond detour point	2L	L,I	1) Use when condition exist > 1 day and outside major work area.
D-704-19	F	Lane closure with flagger control (depicts obstructed visibility)	2L	L,I	1) Use when condition exist > 1 day and outside major work area. 2) Application: generally used when traffic must be restricted from the work area. Typically the traffic control devices and flagging would remain in-place overnight, if the operation requires daily set-up consideration should be given to an alternative channelizing device. A pilot car may be used to supplement the flagging control. 3) Tubular Markers or Traffic Cones may be substituted for Delineator Drums by plan note, pending engineering analysis. Cones shall not be used when conditions exist over night time.
D-704-21	J	Lane closure with widened section to maintain two-way traffic	2L	L,I	1) Use when condition exist > 1 day and outside major work area.
D-704-22	M	Temporary detour for culvert installation	2L	S	1) Use when condition exist < 1 day and within the major work area. Use in daylight with good visibility only. 2) "Sharp" curve signs (W1-3-48 & W13-1-24) should be used on cures with design speeds of 30 mph or less.
D-704-22	N	Temporary lane closure with flaggers to maintain traffic	2L	S	1) Use when condition exist < 1 day and within the major work area.
D-704-31	na	Lane closure with stop sign control	2L	L,I	1) Use when condition exist > 1 day and outside major work area. 2) Application: use on structures only, when the roadway has an ADT <750. Work areas are typically short in length (<1000 ft). 3) Work area geometry should be reviewed for adequate sight distance and visibility.
D-704-27	na	Pavement Marking - moving operation	2L & 4L	M	1) Applications: TCP (3-1a), Undivided Multilane Roadway. TCP (3-1b), Two-Way Roadway With Paved Shoulders. TCP (3-1c), Two-Way Roadway Without Paved Shoulders.
D-704-20	H	Construction signing - for seal coats with traffic maintained (includes signing for intersecting routes)	2L & 4L	L,I	1) Construction signing is installed to delineate the construction zone (project boundaries) outside of the work area. The purpose is to inform the motorist that construction activities should be anticipated. 2) The designer should review the roadway ADT and intersection locations. A plan note or detailed drawing should be included to address intersection locations and short-term markings.. 2) Use spotting tabs on all seal coat projects in accordance to

APPLICATION OF STANDARD DRAWINGS FOR CONSTRUCTION SIGNING					
Std Dwg No.	CSL Type	Description	Roadway Type	Duration	Comments
					Section 704.04 D.1.e and Std. Dwg. D-704-3. 3) See example note 762 - P01, to revise method of payment, when short-term pavement markings are not provided.
D-704-20	G	Construction signing - with traffic maintained (includes signing for intersecting routes)	2L, 4L, & 4LD	L	1) Construction signing is installed to delineate the construction zone (project boundaries) outside of the work area. The purpose is to inform the motorist that construction activities should be anticipated. As a rule of thumb, construction signing should be provided if the anticipated duration is > 2 weeks. 2) The designer should review the intersection locations. A plan note or detailed drawing should be included to address intersection locations. 3) The designer should review the need for sign no. G20-1b-60 and address by plan note.
D-704-21	I	Detour signing - roadway closure	2L, 4L, & 4LD	L,I	1) The advance warning sign sequence should be revised to show a lane closure for 4L and 4LD application.
D-704-22	O	Construction signing - tee-intersection with traffic maintained	2L, 4L, & 4LD	L,I	1) Construction signing is installed to delineate the construction zone (project boundaries) outside of the work area. The purpose is to inform the motorist that construction activities should be anticipated. 2) The designer should review the intersection locations. A plan note or detailed drawing should be included to address intersection locations. 3) The designer should review the need for sign no. G20-1b-60 and address by plan note.
D-704-29	na	Pavement Marking - individual unit operation	2L, 4L & 4LD	M	1) Applications: Two-Way Roadway With Paved Shoulders. Two-Way Roadway Without Paved Shoulders. Divided Multi-Lane Highway. Undivided Multi-Lane Highway.
D-704-02	na	Coring for hot bituminous pavement	2L, 4L, 4LD & Int	M	1) Use on HBP projects when cores for specified density are required. 2) Use in daylight with good visibility only.
D-704-15	C	2 Roadway closure with traffic maintained	4L	L,I	1) Use when condition exist > 1 day or outside major work area. 2) The work area should be returned to a non-hazardous or traversable condition at the end on the work day. 3) Tubular Markers may be substituted for Traffic Cones by plan note.
D-704-19	D	Roadway closure with traffic maintained by	4LD	L,I	1) Use when condition exist > 1 day and outside major work area. 2) The use of positive barriers should be based on need determined

APPLICATION OF STANDARD DRAWINGS FOR CONSTRUCTION SIGNING					
Std Dwg No.	CSL Type	Description	Roadway Type	Duration	Comments
		temporary crossover and detour to other roadway			by engineering analysis and duration of project. Use Std. Dwg. for Interstate crossovers if barriers are required. 3) The alignment may be designed using standard tapers or AASHTO design criteria for curves.
D-704-23	P	Lane closure	4LD	L,I,S	1) Use on stationary operations that do encroach the driving lane (L or R), and flagging is not required. 2) Applications include guardrail, etc. Projects are generally shorter in length (begin and end of project visible), but may extend to approx. 3 miles in length. 3) The lane closure may remain in-place overnight or be removed. If used overnight, Tubular Markers shall be substituted for Traffic Cones.
D-704-33	na	Lane closure, with inside approach shown	4LD	L,I	1) Use on operations that encroach the driving lane and require flagging. 2) Applications include HBP overlays, seal coats, CPR, grinding, etc. The daily construction area is generally limited to <6 miles in length (by plan note). 3) The lane closure may remain in place overnight or be removed depending on roadway hazard condition. 4) Excavation should be <1 ft and hazardous conditions should be removed or traversable at night. 5) The designer should verify the approach location. 6) The designer may limit length and quantities by providing a plan note and detailing quantities provided.
D-704-34	na	Lane closure, with outside approach shown	4LD	L,I	1) Use on operations that encroach the driving lane and require flagging. 2) Applications include HBP overlays, seal coats, CPR, grinding, etc. The daily construction area is generally limited to <6 miles in length (by plan note). 3) The lane closure may remain in place overnight or be removed depending on roadway hazard condition. 4) Excavation should be <1 ft and hazardous conditions should be removed or traversable at night. 5) The designer should verify the approach location. 6) The designer may limit length and quantities by providing a plan note and detailing quantities provided.
D-704-28	na	Pavement Marking - moving operation	4LD, Int	M	1) Applications: Divided Highways or Interstate with 3 or more lanes.
D-704-32	na	Lane closure, moving operation	4LD, Int	M	

APPLICATION OF STANDARD DRAWINGS FOR CONSTRUCTION SIGNING					
Std Dwg No.	CSL Type	Description	Roadway Type	Duration	Comments
D-704-18	na	Lane closure with portable barriers	Int	L,I	1) Use when hazardous conditions exist next to the driving lane 2) Applications include structural repair, pipe installation, excavation, etc. The project length is generally limited. 3) The use of barriers and attenuation devices (hazardous conditions) should be based on need determined by engineering analysis. If hazardous conditions are not present use Std. Dwg. D-704-35.
D-704-35	na	Lane closure	Int	L,I	1) Use on operations that encroach the driving lane and require flagging. 2) Applications include HBP overlays, seal coats, CPR, grinding, etc. The daily construction area is generally limited to <6 miles in length (by plan note). 3) The lane closure may remain in place overnight or be removed depending on roadway hazard condition. 4) Excavation should be <1 ft and hazardous conditions should be removed or traversable at night. 5) The designer may limit length or quantities by providing a plan note and detailing quantities provided.
D-704-38	na	TCS - Median crossover (begin), 55 mph	Int	L	
D-704-39	na	TCS - Median crossover (end), 55 mph	Int	L	
D-704-40	na	TCS - Median crossover (begin), 65 mph	Int	L	
D-704-41	na	TCS - Median crossover (end), 65 mph	Int	L	
D-704-43	na	TCS - Median crossover (begin), 70 mph	Int	L	
D-704-44	na	TCS - Median crossover (end), 70 mph	Int	L	
D-704-25	V	Partial roadway closure (mid-block)	MS	S	1) Use in daylight with good visibility only.
D-704-25	W	Work area outside roadway, no partial closure	MS	S	1) Use in daylight with good visibility only.
D-704-25	X	Partial roadway closure (end-block)	MS	S	1) Use in daylight with good visibility only.
D-704-23	Q	Detour signing - city street closure	MS & U	L,I,S	

**APPLICATION OF STANDARD DRAWINGS FOR CONSTRUCTION SIGNING**

**Roadway Type Definitions:**

All	=	All roadways.
2L	=	2 Lane Roadways.
4L	=	4 Lane Roadways.
4LD	=	4 Lane Divided Roadways.
Int	=	Interstate Roadways.
MS	=	Major Streets.
U	=	Urban Streets.

**Duration Definitions:**

na	=	Not applicable.
L	=	Long term stationary - > 3 days.
I	=	Intermediate term stationary - overnight #3 days.
S	=	Short term stationary - anytime > 60 minutes.
SD	=	Short Duration - anytime # 60 minutes.
M	=	Mobile - Intermittent and continuously moving.

**Other Definitions:**

- 1) **Outside the Major Work Area.** Advance construction signing is not provided with shown signing.
- 2) **Within the Major Work Area.** Advance construction signing is provided with shown signing.
- 3) **Major Intersection.** A major intersection is defined as intersecting a County Major Collector (CMC), State Highway, U.S. Highway, or Interstate ramp. Intersections with other County Roads and Local Roads may be considered major based on traffic volumes.
- 4) **High volume local road.** A high volume local road has an ADT greater than 750.
- 5) **Low volume local road.** A low volume local road has an ADT less than 750.
- 6) **Approach.** An approach is any entrance onto a roadway or access to a roadway, including other roadways. Typically an existing approach controlled by an existing yield or stop condition should be considered in the Traffic Control Plan.



## Maintaining Traffic on Roadways Requiring Excavation/Embankment

The NDDOT will maintain traffic at all times during a construction project. On projects that require part or all of the roadway to be excavated or embankment placed, traffic can be maintained by constructing half of the roadway at a time, installation of a temporary bypass, or the use of a detour route.

### III-18A.01 One Lane Closure/Half at a Time

Construction of the roadway half at a time consists of closing one lane of traffic, and using half the roadbed at a time to maintain traffic. Typically, replacement of small to medium diameter centerline culverts in shallow to moderate depth, subcut, and other subgrade work will require construction half at a time. Deeper pipe or larger diameter pipe can be replaced half at a time by building a flare on each side of the pipe.

#### Design Requirements

- **Typical Section** - A 15 ft wide top of roadway should be maintained to allow for a 12 ft lane with 1.5 ft on each side for necessary traffic control devices. To achieve the required roadway width, temporary embankment and surfacing may be needed to widen half of the roadway. If site conditions are limited, a 14 ft minimum top width can be used.

Ideally the work being done on half the roadway can be completed in one day. At the end of the day, the excavation can be backfilled, and a minimum 24 ft wide top of roadway with 4:1 foreslopes can be provided to maintain traffic overnight. If this cannot be accomplished, flagging will be required overnight, or until a full roadway section can be provided.

- **Profile** – A 7% maximum grade will be used for the temporary entrance and exit to the pipe removal area.

Depending on pipe depth, roadway width and foreslopes, a substantial amount of pavement and sub-grade removal could be required to provide a 7% grade. The cost to replace a deep pipe half at a time may cost more than replacing the pipe utilizing a temporary bypass. An economic analysis should be conducted to determine if the additional removals and proposed pavement costs are greater than a bypass.

- **Work Zone Traffic Control** – Stackable vertical panels should be used on both sides of the maintained lane of traffic to delineate the path for drivers. Flaggers will be required on both ends to alternate traffic from each direction. A pilot car may be needed depending on the length of the closure and sight distance considerations.

If traffic is returned to head to head on a gravel surface at night, tubular markers should be used to mark the centerline of the roadway.

- **Plan Sheet Requirements**
  - **Detail or Plan Sheet** - A detail sheet and/or a plan note to explain the removal

and replacement strategy. Necessary information shall include minimum roadway width, removal depth, max grade, max foreslope and traffic control strategy.

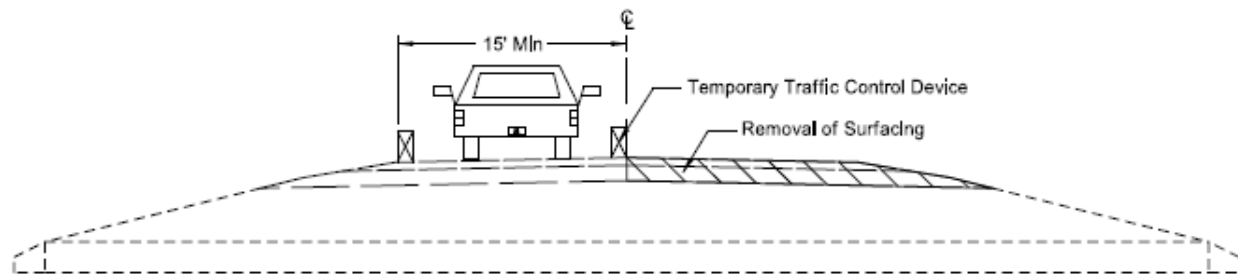
- **Quantities** – All items that will be paid for separately at each pipe replacement location on the project including: pavement & base removal, temporary surfacing, work zone traffic control devices, etc.

### **Example – Shallow Pipe with Small Diameter**

The process of replacing the pipe half at a time is specific to each location because site conditions create different design constraints. An example of the progression of removal and replacement of the pipe and pavement is shown below via typical sections.

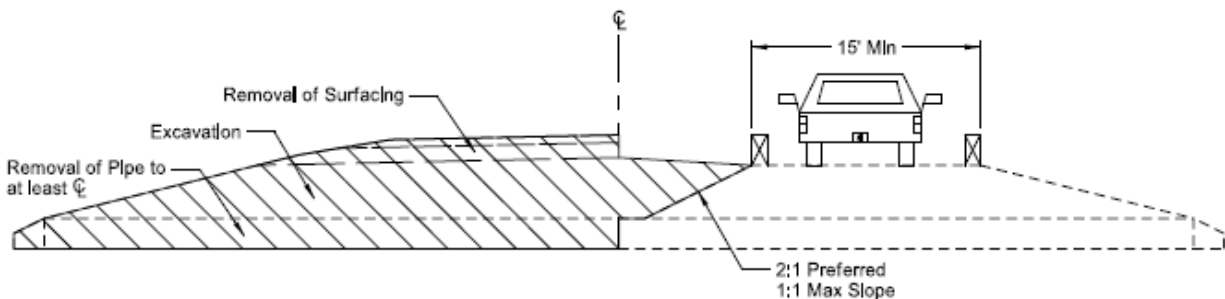
This example is a relatively shallow 24" pipe, 5.5 ft from top of pavement, which could be replaced half at a time with minimal pavement removals. The roadway width is 30', 6" HBP over 12" of aggregate base with 4:1 existing foreslopes.

The first step is to switch traffic to one side using necessary traffic control devices and flaggers. A minimum 15' roadway width is required. The surfacing and base is removed to the top of the sub-grade on the right side. The pavement is removed an adequate distance perpendicular from the centerline of the pipe to ensure a 7% grade. In this example, 6" HBP plus 12" base equals 18" removal depth, which gives a removal length of 21.4' on each side perpendicular to the pipe.



**Figure III-18A-1**

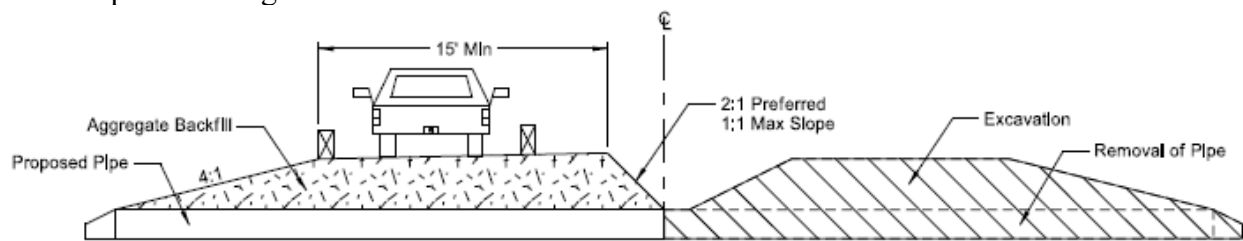
Next, traffic is switched to the right side where a minimum 15' roadway width is required. A 2:1 slope on the left side is desired with a 1:1 max slope. During this step, at least one half of the pipe should be removed. Excavation for the pipe trench should be conducted on the left side. The pavement on the left side should be removed to the extents matching the limits of the previous step.



**Figure III-18A-2**

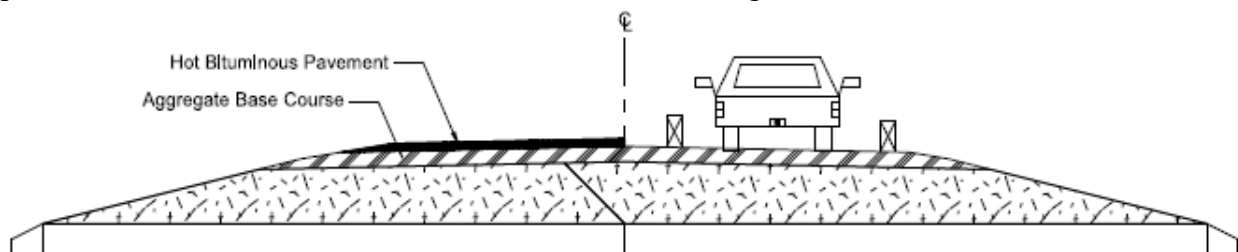
Then, traffic is switched back to the left side where one half of the new pipe has been placed and aggregate has been backfilled to the top of the subgrade if possible. The remaining quantity of

pipe is removed and replaced. The other half of the trench is excavated and properly backfilled to the top of the subgrade.



**Figure III-18A-3**

Once the subgrade is in place, the proposed aggregate base course and asphalt surfacing are placed. Each is done one half at a time to maintain the single lane of traffic.



**Figure III-18A-4**

This strategy works well for shallow pipes. Previous economic analysis on NDDOT projects has shown that it is cost effective to use this strategy when the fill over the pipe is 6 feet or less. It may become more cost effective to provide a Type 2 temporary bypass when fill over the pipe is 8 feet or greater.

For large diameter or deep pipes it becomes evident that the half at a time strategy can be costly. In such a scenario, a wider and deeper initial removal would be required in Figure III-19A-3. The deeper the initial removal, the longer length of pavement removal to maintain a 7% max grade on the roadway.

Referencing Figure III-19A-4, a large diameter or deep pipe will require the 15' traveled way to be pushed much further to the right. This would be necessary to maintain the 1:1 max slope from the surface of the temporary roadway to the bottom of the pipe trench. This could require additional embankment to construct a wide enough temporary roadway surface.

The above issues; pavement removal, proposed pavement, temporary surfacing, and embankment can increase the cost of the pipe replacement significantly. Decisions should be made on a case by case basis investigating economics and using engineering judgment.

### III-18A.02 Temporary Bypass

Temporary bypasses are commonly used on two way roadways where a short section of the entire roadway width needs to be closed. Temporary bypasses are classified into three types. The type of bypass is related to the duration of the temporary bypass being in place.

Temporary Bypass – Type 1: Typically this type of bypass is used for replacing smaller diameter culverts such as 24” and 30” when the depth of the ditch is about four feet. The replacement of the culverts would normally be accomplished in one day. The temporary bypass is typically constructed by reshaping material that is in place and running traffic in the ditch bottom or sometimes on the backslope. When conditions permit, the Type 1 bypass may be used in lieu of replacing the pipe half at a time with one lane closure. This work is considered very short term and should last 1 day or less.

Temporary Bypass – Type 2: Typically this type of bypass is used for replacing larger diameter pipe, replacing deep pipe, or doing extensive subgrade work. This type of bypass is typically used when the backfill over the pipe is greater than six to eight feet. The work is considered short term and could take up to three days.

Temporary Bypass – Type 3: Typically this type of bypass is used for replacing structures such as bridges, box culverts, or structural plate pipe. The work is considered long term and could take more than three days.

Temporary bypasses should be used when engineering analysis of project cost and traffic control make it more practical than replacing pipe half at a time with one lane closure. Boring or jacking a pipe through the embankment is another alternative, but may be more costly. An engineering and economic analysis should be completed to verify the best practice.

Table III-18A-1

Temporary Bypass Design Guidelines						
Bypass Type	Minimum roadway Width	Aggregate Surfacing Thickness	Foreslope Rate	Minimum Radius	Max Grade	Traffic Control
Type 1 (1 day)	15'	0-2"	4:1	400'	7%	D-704-22M (daytime) D-704-15B (nighttime)
Type 2 (≤3 days)	28'	4"-6"	4:1	400'	7%	D-704-22M (daytime) D-704-15B (nighttime)
Type 3 (> 3 days)	28'	6"-8"	4:1	750'	7%	D-704-15B

**Temporary Bypass – Type 1**

The Temporary Bypass – Type 1 may be used when construction activities are expected to last up to one day. These activities may include the installation of centerline culverts, or other subgrade work. The design guidelines have been based on a 25 mph design speed. Very minimal earthwork is typically required to construct a Type 1 temporary bypass as traffic is typically run on the ditch bottom or sometimes on the backslope.

- **Width** – The minimum top width of the bypass should typically be 15 feet for one lane of traffic.
- **Surfacing** - The surfacing for the bypass will typically be dirt.
- **Foreslope** – A 4:1 foreslope should be used for the bypass. 3:1 slopes could be used if a clear recovery area is available at the bottom of the slope.
- **Horizontal Alignment** – Two elements were considered when determining the minimum radius of curvature for Type 1 bypasses. First, a minimum radius was determined from the Unpaved Roads Section of the *AASHTO Guidelines for Geometric Design of Very Low Volume Local Roads*. The method is the same as in *A Policy* for determining minimum curve radii, except a traction coefficient is used to account for the aggregate surfacing.

**Minimum Radius of Curvature for Temporary Bypass – Type 1****Design speed:** 25 mph**Superelevation (e):** -2.1 (normal crown)**Traction Coefficient:** 0.4**Side Friction (f):** 0.4 - 0.2 = 0.2

$$R_{\min} = \frac{V^2}{15(0.01e + f)} = 232.8 \text{ ft} \rightarrow 250 \text{ ft}$$

Secondly, required traveled way width was considered for sharp radii curves. A bypass with 250 ft radii, would need to be approximately 16 ft wide to accommodate a WB-50 vehicle. Based on this, a slightly larger minimum radius will allow a narrower bypass width. This was determined from required traveled way width on a curve from *A Policy*.

#### Minimum Traveled Way Width on a Curve

**Design speed:** 25 mph

**Radius of Curvature:** 400 ft

**Number of Lanes (N):** 1

**Design Vehicle:** WB-50

**Track width of Design Vehicle (U):** 10.2 ft

**Lateral Clearance (C):** 3 ft

**Width of Front Overhang (F<sub>A</sub>):** 0.09

**Extra Width Allowance (Z):** 1.25 ft

$W_c = N(U+C)+(N-1)F_A+Z = 1(10.2+3)+(1-1)0.09+1.25 = 14.45 \text{ ft} \rightarrow 15 \text{ ft}$

Based on these two elements, 400 ft was selected as the minimum radius for design of Type 1 bypasses. In cases where smaller radii are required, the travel way width may need to be increased.

- **Vertical Profile** - The maximum grade of Type 1 temporary bypasses shall be 7%. Crest and sag vertical curves shall follow *A Policy* for a 25 mph design speed.
- **Work Zone Traffic Control** – Work zone traffic control for a Temporary Bypass – Type 1 should be in accordance with Standard Drawing D-704-22 Layout Type M if operations will be during daylight hours only. If the bypass is in use overnight, traffic control should be in accordance with Standard Drawing D-704-15 Layout Type B and an advisory plate for 25 mph should be used.
- **Plan Sheet Requirements**
  - **Typical Section** – Roadway width, foreslope rate, etc.
  - **Horizontal Alignment** – Plan view layout, stationing, curve info, etc
  - **Pay Items** – Estimated quantities that are paid for separately such as, embankment items, surfacing items, temporary conduits, erosion control items, work zone traffic control items, removal of bypass, etc.
  - **Non-Pay Items** – Estimated quantities that are not paid for separately. Removal of bypass can be paid for by the each (EA).

If full survey is available in the area of the bypass, consideration should be given to including a profile and cross-sections.

**Temporary Bypass – Type 2**

Temporary Bypass – Type 2 may be used when construction activities are expected to last 3 days or less. These activities may include the installation of centerline culverts, RR crossings, or other subgrade work. The design guidelines have been based on a 25 mph design speed.

- **Width** – The minimum top width of the bypass should be 28 feet. This is based on two - 12 foot driving lanes with additional widening through the curves for two WB-50 design vehicles to meet on the bypass and have adequate room to pass. In areas of high truck traffic and oversized loads, additional width may be considered.
- **Surfacing** - The surfacing for the bypass will generally be aggregate. The minimum depth of aggregate surfacing shall be 4 inches. When truck traffic on the original roadway equals 10% or more of the original ADT, the thickness may be increased to 6 inches. Engineering judgment may be used to add additional depth.
- **Foreslope** – A 4:1 foreslope should be used for the bypass. 3:1 slopes could be used if a clear recovery area is available at the bottom of the slope.
- **Horizontal Alignment** – Two elements were considered when determining the minimum radius of curvature for Type 2 bypasses. First, a minimum radius was determined from the Unpaved Roads Section of the *AASHTO Guidelines for Geometric Design of Very Low Volume Local Roads*. The method is the same as in *A Policy* for determining minimum curve radii, except a traction coefficient is used to account for the aggregate surfacing.

**Minimum Radius of Curvature for Temporary Bypass – Type 2**

**Design speed:** 25 mph

**Superelevation (e):** -2.1 (normal crown)

**Traction Coefficient:** 0.4

**Side Friction (f):** 0.4 - 0.2 = 0.2

$$R_{\min} = \frac{V^2}{15(0.01e + f)} = 232.8 \text{ ft} \rightarrow 250 \text{ ft}$$

Secondly, required traveled way width was considered for sharp radii curves and the ability for vehicles to navigate and meet each other on such a bypass. A bypass with 250 ft radii, would need to be approximately 31 ft wide to allow two WB-50 vehicles to pass each other. Based on this, a slightly larger minimum radius will allow a narrower bypass width. This was determined from required traveled way width on a curve from *A Policy*.

Minimum Traveled Way Width on a Curve**Design speed:** 25 mph**Radius of Curvature:** 400 ft**Number of Lanes (N):** 2**Design Vehicle:** WB-50**Track width of Design Vehicle (U):** 10.2 ft**Lateral Clearance (C):** 3 ft**Width of Front Overhang (F<sub>A</sub>):** 0.09**Extra Width Allowance (Z):** 1.25 ft

$$W_c = N(U+C)+(N-1)F_A+Z = 2(10.2+3)+(2-1)0.09+1.25 = 27.74 \text{ ft} \rightarrow 28 \text{ ft}$$

Based on these two elements, 400 ft was selected as the minimum radius for design of Type 2 bypasses. In cases where smaller radii are required, the travel way width may need to be increased.

- **Vertical Profile** - The maximum grade of Type 2 temporary bypasses shall be 7%. Crest and sag vertical curves shall follow *A Policy* for a 25 mph design speed.
- **Work Zone Traffic Control** – Work zone traffic control for Type 2 temporary bypass should be in accordance with Standard Drawing D-704-22 Layout Type M if operations will be during daylight hours only. If the bypass is in use overnight, traffic control should be in accordance with Standard Drawing D-704-15 Layout Type B and an advisory plate for 25 mph should be used.
- **Plan Sheet Requirements**
  - **Typical Section** – Roadway width, foreslope rate, surfacing thickness, etc.
  - **Horizontal Alignment** – Plan view layout, stationing, curve info, etc
  - **Pay Items** – Estimated quantities that are paid for separately such as, embankment items, surfacing items, temporary conduits, topsoil, water, erosion control items, work zone traffic control items, removal of bypass, etc.
  - **Non-Pay Items** – Estimated quantities that are not paid for separately. Removal of bypass can be paid for by the each (EA).

If full survey is available in the area of the bypass, consideration should be given to including a profile and cross-sections.



**Temporary Bypass – Type 3**

Type 3 Temporary Bypass shall be used when construction activities are expected to last longer than 3 days. These activities may include the installation of box culverts, large diameter or deep centerline culverts or other subgrade work. The design guidelines have been based on a 45 mph design speed which is desirable.

- **Width** – The minimum top width of the bypass should be 28 feet. This is based on two - 12 foot driving lanes with additional widening through the curves for two WB-65 design vehicles to meet on the bypass and have adequate room to pass. This was determined from required traveled way width on curve from *A Policy*.

**Minimum Traveled Way Width on a Curve****Design speed:** 45 mph**Radius of Curvature:** 750 ft**Number of Lanes (N):** 2**Design Vehicle:** WB-65**Track width of Design Vehicle (U):** 10 ft**Lateral Clearance (C):** 3 ft**Width of Front Overhang (F<sub>A</sub>):** 0.1**Extra Width Allowance (Z):** 1.64 ft

$$W_c = N(U+C)+(N-1)F_A+Z = 2(10+3)+(2-1)0.1+1.64 = 27.74 \text{ ft} \rightarrow 28 \text{ ft}$$

In areas of high truck traffic and oversized loads, additional width may be warranted.

- **Surfacing** - The surfacing for the bypass will generally be aggregate. The minimum depth of aggregate surfacing shall be 6 inches. When truck traffic on the original roadway equals 10% or more of the original ADT, the thickness can be increased to 8 inches. Engineering judgment may be used to add additional depth. If a bypass is intended for large amounts of traffic for extended periods of time, contact Materials & Research for a pavement design.
- **Foreslope** – A 4:1 foreslope should be used for the bypass. 3:1 slopes could be used if a clear recovery area is available at the bottom of the slope.
- **Horizontal Alignment** – The minimum radius of curvature for bypasses has been determined from the Unpaved Roads Section of the *AASHTO Guidelines for Geometric Design of Very Low Volume Local Roads*. The method is the same as in *A Policy* for determining minimum curve radii, except a traction coefficient is used to account for the aggregate surfacing.

Minimum Radius of Curvature for Temporary Bypass – Type 3**Design speed:** 45 mph**Superelevation (e):** -2.1 (normal crown)**Traction Coefficient:** 0.4**Side Friction (f):** 0.4 - 0.2 = 0.2

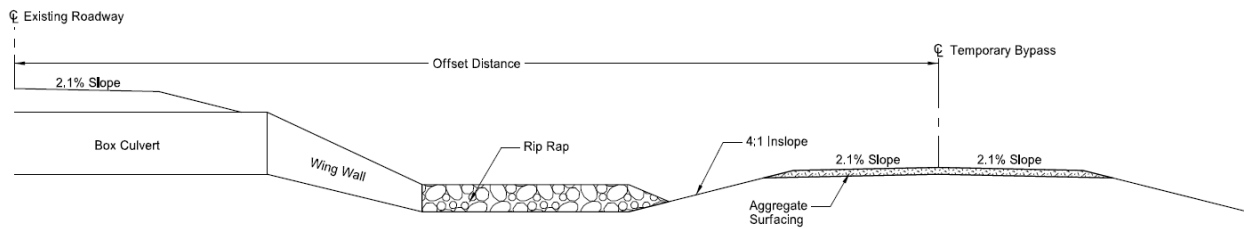
$$R_{\min} = \frac{V^2}{15(0.01e + f)} = 754.2 \text{ ft} \rightarrow \text{Use a design value of 750 ft}$$

A 2.1% max superelevation can be incorporated into bypass curves if desired by the designer. Superelevation and runout and runoff should be computed in accordance with *A Policy*.

- **Vertical Profile** - The maximum grade of Type 3 temporary bypasses shall be 7%. Crest and sag vertical curves shall follow *A Policy* for a 45 mph design speed.
- **Work Zone Traffic Control** – Work zone traffic control for Type 3 temporary bypasses should be in accordance with Standard Drawing D-704-15 Layout Type B.
- **Plan Sheet Requirements**
  - **Typical Section** – Roadway width, foreslope rate, surfacing thickness, etc.
  - **Horizontal Alignment** – Plan view layout, stationing, curve info, etc
  - **Profile** – grades, vertical curve info, etc.
  - **Cross-sections** – if full survey is available, cross section should be provided.
  - **Pay Items** – Estimated quantities that are paid for separately such as, embankment items, surfacing items, temporary conduits, topsoil, water, erosion control items, work zone traffic control items, removal of bypass, etc.
  - **Non-Pay Items** – Estimated quantities that are not paid for separately. Removal of bypass can be paid for by the each (EA).

Offset from Work Zone

There needs to be enough space between the roadway and the bypass for work to be done in the construction zone. For example, a project replacing a box culvert needs 12'-18' for the wings of the culvert, 20' for riprap, foreslope distances for both the roadway and the bypass, and additional space for standard construction movement. The engineer shall determine the appropriate offset distance considering all necessary design variables including but not limited to cost and right of way. Figure III-19.07 shows a potential scenario.



**Figure III-18A-5 Proposed Cross Section Example**

### III-18A.03 Detour Routes

Detour routes involve closing the roadway completely and signing an alternate route for traffic. Detours should only be used if it is the only feasible alternative, or other methods are prohibited by cost. Closure of a roadway and use of a detour route will require approval by the Deputy Director for Engineering.

- **Traffic Control** - Long distance rural detour routes shall be signed in accordance with Standard Drawing D-704-21 Layout Type I.

Shorter distance urban detour routes shall be signed in accordance with Standard Drawing D-704-23 Layout Type Q.

- **Plan Sheet Requirements**
  - **Detour Route Layout**
  - **Quantities**

### III-19-01 Landscaping/Billboards

Landscaping and plantings within the right-of-way should not obstruct the view or interfere with the effectiveness of any sign legally in place under the provisions of NDCC 24-17 and the rules adopted by the Director.

Restricted Planting Zones will be used within the right of way to ensure that lawfully permitted, erected billboards (and those recently permitted but installation is still pending) can be seen from the main traveled highway even after the plantings are fully mature. To locate lawfully permitted billboards, contact the Maintenance Division. An outdoor advertising permit holder has one year from the date of issue to install the sign.

The Restricted Planting Zone applies only to the roadway in the vicinity of the billboard’s location. For multi-directional billboards, a Restricted Planting Zone applies in each direction \*.

The width of the Restricted Planting Zone extends from the shoulder of the roadway to the right of way line, the length is based upon the posted speed limit as shown in Table III-19.01:

Posted Speed limit	Distance (X)
Below 45	250 ft
46 – 65	350 ft
Above 65	450 ft

Table III-19.01

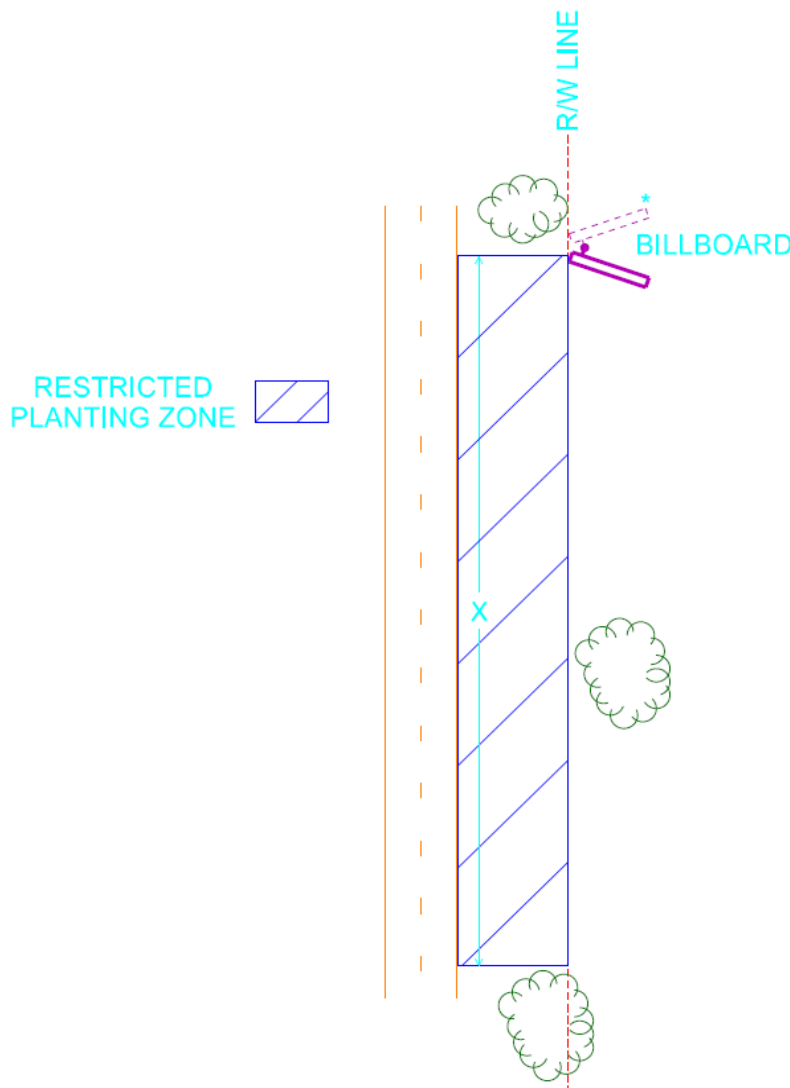


Figure III-19.01  
Landscaping at Billboards