

STANDARD HIGHWAY SIGNS

SUPPLEMENTAL
MANUAL

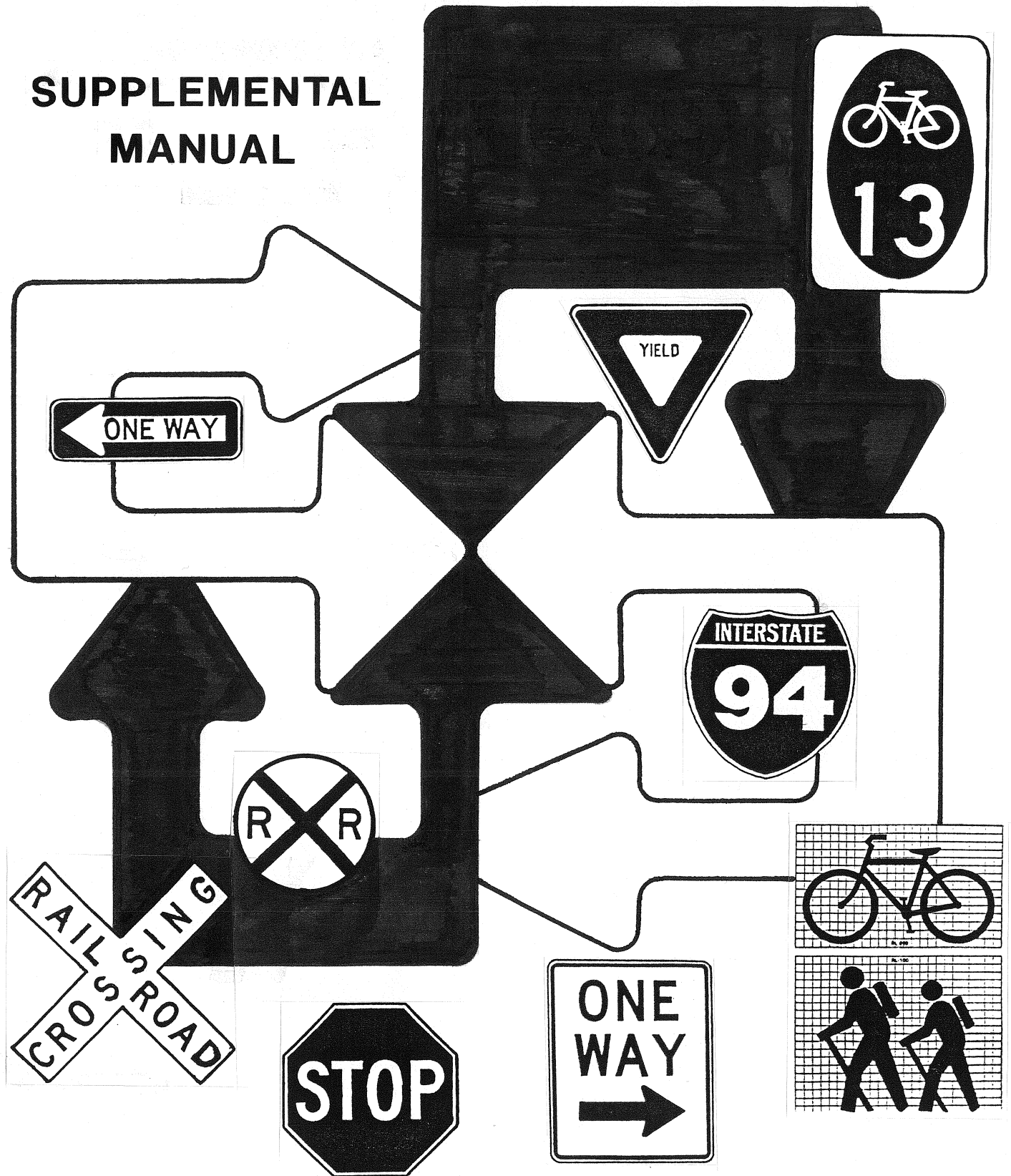

NORTH DAKOTA DEPARTMENT OF TRANSPORTATION

**NORTH DAKOTA
DEPARTMENT OF TRANSPORTATION**

**STANDARD
HIGHWAY SIGNS**

Supplemental Manual

Prepared by

**NORTH DAKOTA DEPARTMENT OF TRANSPORTATION
BISMARCK, NORTH DAKOTA**

COMMISSIONER/DIRECTOR

Richard J. Backes

DESIGN DIVISION

**David K. O. Leer, Design Engineer
(701) 224-2555**

May 1, 1990

SIGN TABLE OF CONTENTS
TRAFFIC SECTION - DESIGN DIVISION
N.D. DEPARTMENT OF TRANSPORTATION

TYPE	DESCRIPTION	SIGN_CODE	CH/PG
Regulatory	To Oncoming Traffic	R1-4A	1- 1
Regulatory	Lane-Use Control-Straight Ahead (Symbol)	R3-6A	1- 2
Regulatory	Lane-Use Control-Mandatory Movement (Straight & Right Arrow)	R3-8A	1- 3
Regulatory	Lane-Use Control-Mandatory Movement (Left & Straight Arrow)	R3-8B	1- 4
Regulatory	No Parking This Side Of Street	R7-1A	1- 5
Regulatory	No Parking Here to Corner	R7-11A	1- 6
Regulatory	Semi Truck Parking	R8-1C	1- 7
Regulatory	Pickup and Camper Parking	R8-1D	1- 8
Regulatory	Noise Ordinance Enforced	R8-1E	1- 9
Regulatory	No Truck Parking	R8-1F	1-10
Regulatory	Emergency Vehicles Only	R8-4A	1-11
Regulatory	No Fishing From Bridge	R9-3K	1-12
Regulatory	No Fishing From Roadway	R9-3L	1-13
Regulatory	Left Turn Protected On Green Arrow Only	R10-5A	1-14
Regulatory	Emergency Signal	R10-11	1-15
Regulatory	Yield To Pedestrian In Crosswalk	R10-13	1-16
Regulatory	No Overnight Camping	R-96	1-17
Regulatory	Dogs Must Be Leashed	R-100	1-18
Regulatory	Do Not Cultivate Highway Right of Way	R-101	1-19
Regulatory	Snow Emergency Route	R17-1	1-20
Regulatory	Unauthorized Parking Mandates \$100 Fee	R7-8A	1-5A
Warning	Buried Power Line - Volts and Depth	R18-1	2- 1
Warning	School Bus Turn Ahead	S3-1K	2- 2
Warning	School Entrance	S3-3	2- 3

SIGN TABLE OF CONTENTS
TRAFFIC SECTION - DESIGN DIVISION
N.D. DEPARTMENT OF TRANSPORTATION

TYPE	DESCRIPTION	SIGN_CODE	CH/PG
Warning	Stream Ford	W5-2B	2- 4
Warning	Narrow Bridge 1/2 Mile	W5-2K	2- 5
Warning	Bridge May Be Icy	W5-2L	2- 6
Warning	Watch For Ice On Bridge	W5-2M	2- 7
Warning	Livestock At Large	W5-2N	2- 8
Warning	Traffic Entering Highway	W5-2O	2- 9
Warning	One Lane Bridge 1/2 Mile	W5-3A	2-10
Warning	Pavement Begins	W8-50	2-11
Warning	Broken Pavement	W8-50A	2-12
Warning	Watch For High Water	W8-12	2-13
Warning	Low Flying Aircraft	W8-5B	2-14
Warning	Look For Trains	W10-1K	2-15
Warning	Equestrian (Symbol)	W11-7A	2-16
Warning	Watch For Smoke	W11-7D	2-17
Guide	State Route Marker (Independent Use)	M1-5	3- 1
Guide	State Route Marker (Guide Sign Use)	M1-5A	3- 2
Guide	American Legion - Memorial Highway	M1-95	3- 3
Guide	Lewis And Clark Trail	M1-96	3- 4
Guide	Old West Trail	M1-97	3- 5
Guide	Explorers High Road	M1-112	3- 6
Guide	Frontage Road	M6-7P	3- 7
Guide	_____ Miles	M6-11	3- 8
Guide	Advance Turn Arrow (Bikeway)	M7-8	3- 9
Guide	Advance Turn Arrow (Bikeway)	M7-11	3-10
Guide	Marina - Symbol	R6-090	3-11

SIGN TABLE OF CONTENTS
TRAFFIC SECTION - DESIGN DIVISION
N.D. DEPARTMENT OF TRANSPORTATION

TYPE	DESCRIPTION	SIGN_CODE	CH/PG
Guide	Business District	D1-3K	3-12
Guide	Visitor Parking	D4-5	3-13
Guide	Picnic Symbol and M6-7K	D5-5K	3-14
Guide	Skiing Symbol and M6-7M	D9-50	3-15
Guide	Boat Ramp Symbol and M6-7K	RW-080	3-16
Construction	Next _____ Miles	W5-2P	4- 1
Construction	Trucks Entering Highway	W8-53	4- 2
Construction	Trucks Entering _____	W8-54	4- 3
Construction	Trucks Crossing _____	W8-55	4- 4
Construction	Right Two Lanes Closed	W20-9	4- 5
Construction	Be Prepared To Stop	W20-50	4- 6
Construction	Equipment Working	W20-51	4- 7
Construction	Next _____ Miles	W20-52	4- 8
Construction	Bridge Painting _____	W21-50	4- 9
Construction	Material on Roadway	W21-51	4-10
Construction	Road Construction Next _____ Miles	G20-1	4-11
Construction	Temporary Surface Next _____ Miles	G20-8	4-12
Construction	Road Construction - Next _____ Miles - Next _____ Miles	G20-50	4-13
Construction	Road Construction Next _____ Miles	G20-52	4-14
Construction	Overhead Bridge Painting	G20-54	4-15

SIGN INDEX
TRAFFIC SECTION - DESIGN DIVISION
N.D. DEPARTMENT OF TRANSPORTATION

TYPE	DESCRIPTION	SIGN_CODE	CH/PG
Guide	Advance Turn Arrow (Bikeway)	M7-11	3-10
Guide	Advance Turn Arrow (Bikeway)	M7-8	3- 9
Guide	American Legion - Memorial Highway	M1-95	3- 3
Construction	Be Prepared To Stop	W20-50	4- 6
Guide	Boat Ramp Symbol and M6-7K	RW-080	3-16
Warning	Bridge May Be Icy	W5-2L	2- 6
Construction	Bridge Painting _____	W21-50	4- 9
Warning	Broken Pavement	W8-50A	2-12
Warning	Buried Power Line - Volts and Depth	R18-1	2- 1
Guide	Business District	D1-3K	3-12
Regulatory	Do Not Cultivate Highway Right of Way	R-101	1-19
Regulatory	Dogs Must Be Leashed	R-100	1-18
Regulatory	Emergency Signal	R10-11	1-15
Regulatory	Emergency Vehicles Only	R8-4A	1-11
Warning	Equestrian (Symbol)	W11-7A	2-16
Construction	Equipment Working	W20-51	4- 7
Guide	Explorers High Road	M1-112	3- 6
Guide	Frontage Road	M6-7F	3- 7
Regulatory	Lane-Use Control-Mandatory Movement (Left & Straight Arrow)	R3-8B	1- 4
Regulatory	Lane-Use Control-Mandatory Movement (Straight & Right Arrow)	R3-8A	1- 3
Regulatory	Lane-Use Control-Straight Ahead (Symbol)	R3-6A	1- 2
Regulatory	Left Turn Protected On Green Arrow Only	R10-5A	1-14
Guide	Lewis And Clark Trail	M1-96	3- 4
Warning	Livestock At Large	W5-2N	2- 8

SIGN INDEX
TRAFFIC SECTION - DESIGN DIVISION
N.D. DEPARTMENT OF TRANSPORTATION

TYPE	DESCRIPTION	SIGN_CODE	CH/PG
Warning	Look For Trains	W10-1K	2-15
Warning	Low Flying Aircraft	W8-58	2-14
Guide	Marina - Symbol	RG-090	3-11
Construction	Material on Roadway	W21-51	4-10
Warning	Narrow Bridge 1/2 Mile	W5-2K	2- 5
Construction	Next _____ Miles	W20-52	4- 8
Construction	Next _____ Miles	W5-2P	4- 1
Regulatory	No Fishing From Bridge	R9-3K	1-12
Regulatory	No Fishing From Roadway	R9-3L	1-13
Regulatory	No Overnight Camping	R-96	1-17
Regulatory	No Parking Here to Corner	R7-11A	1- 6
Regulatory	No Parking This Side Of Street	R7-1A	1- 5
Regulatory	No Truck Parking	R8-1F	1-10
Regulatory	Noise Ordinance Enforced	R8-1E	1- 9
Guide	Old West Trail	M1-97	3- 5
Warning	One Lane Bridge 1/2 Mile	W5-3A	2-10
Construction	Overhead Bridge Painting	G20-54	4-15
Warning	Pavement Begins	W8-50	2-11
Regulatory	Pickup and Camper Parking	R8-1D	1- 8
Guide	Picnic Symbol and M6-7K	D5-5K	3-14
Construction	Right Two Lanes Closed	W20-9	4- 5
Construction	Road Construction - Next _____ Miles - Next _____ Miles	G20-50	4-13
Construction	Road Construction Next _____ Miles	G20-52	4-14
Construction	Road Construction Next _____ Miles	G20-1	4-11

SIGN INDEX
TRAFFIC SECTION - DESIGN DIVISION
N.D. DEPARTMENT OF TRANSPORTATION

TYPE	DESCRIPTION	SIGN_CODE	CH/PG
Warning	School Bus Turn Ahead	S3-1K	2- 2
Warning	School Entrance	S3-3	2- 3
Regulatory	Semi Truck Parking	R8-1C	1- 7
Guide	Skiing Symbol and M6-7M	D9-50	3-15
Regulatory	Snow Emergency Route	R17-1	1-20
Guide	State Route Marker (Guide Sign Use)	M1-5A	3- 2
Guide	State Route Marker (Independent Use)	M1-5	3- 1
Warning	Stream Ford	W5-2B	2- 4
Construction	Temporary Surface Next _____ Miles	G20-8	4-12
Regulatory	To Oncoming Traffic	R1-4A	1- 1
Warning	Traffic Entering Highway	W5-20	2- 9
Construction	Trucks Crossing _____	W8-55	4- 4
Construction	Trucks Entering Highway	W8-53	4- 2
Construction	Trucks Entering _____	W8-54	4- 3
Regulatory	Unauthorized Parking Mandates \$100 Fee	R7-8A	1-5A
Guide	Visitor Parking	D4-5	3-13
Warning	Watch For High Water	W8-12	2-13
Warning	Watch For Ice On Bridge	W5-2M	2- 7
Warning	Watch For Smoke	W11-7D	2-17
Regulatory	Yield To Pedestrian In Crosswalk	R10-13	1-16
Guide	_____ Miles	M6-11	3- 8

REGULATORY SIGNS

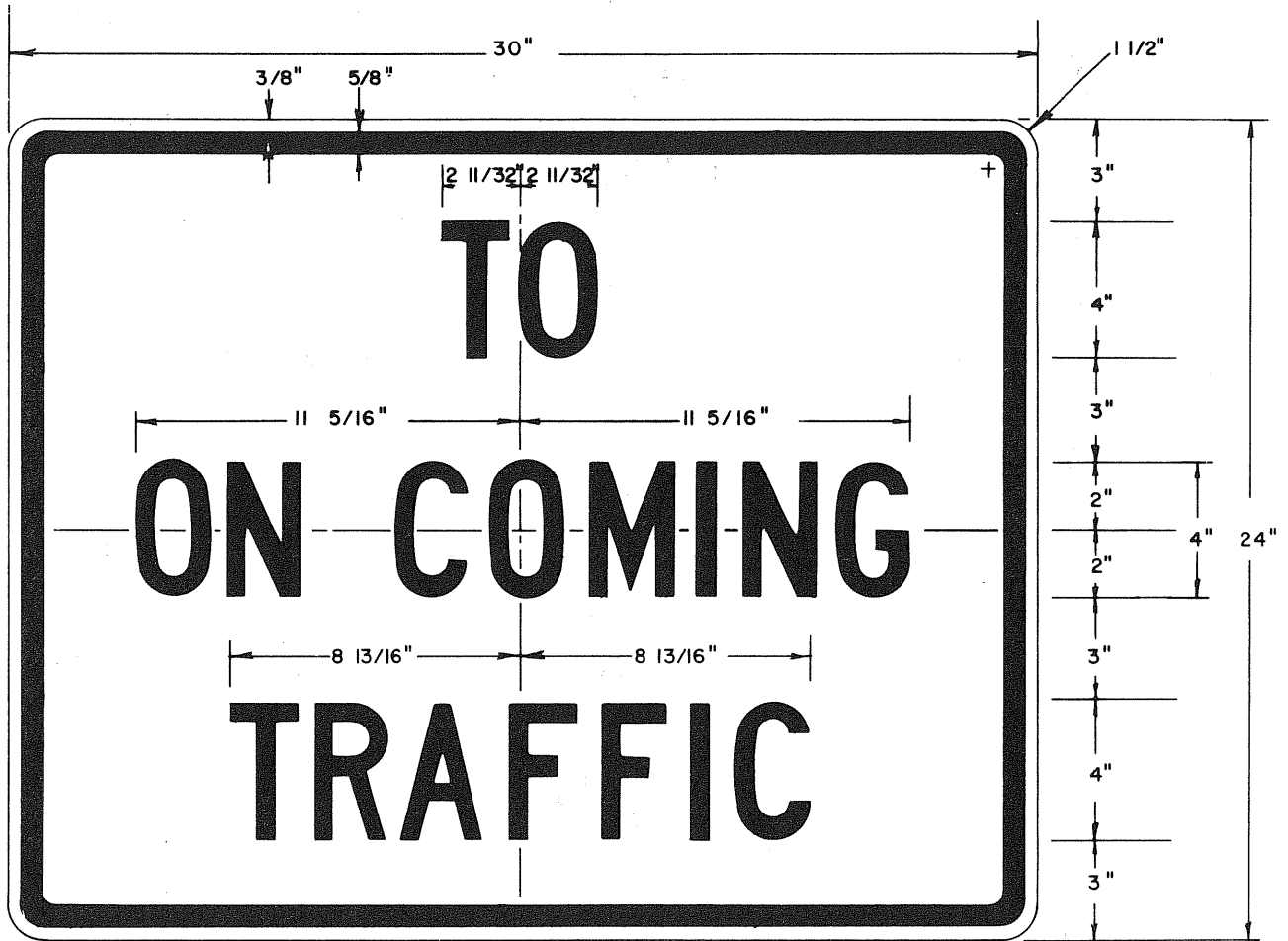

SERIES 4c

COLORS

LEGEND-RED (REFL)
 BACKGROUND-WHITE (REFL)

RI-4a

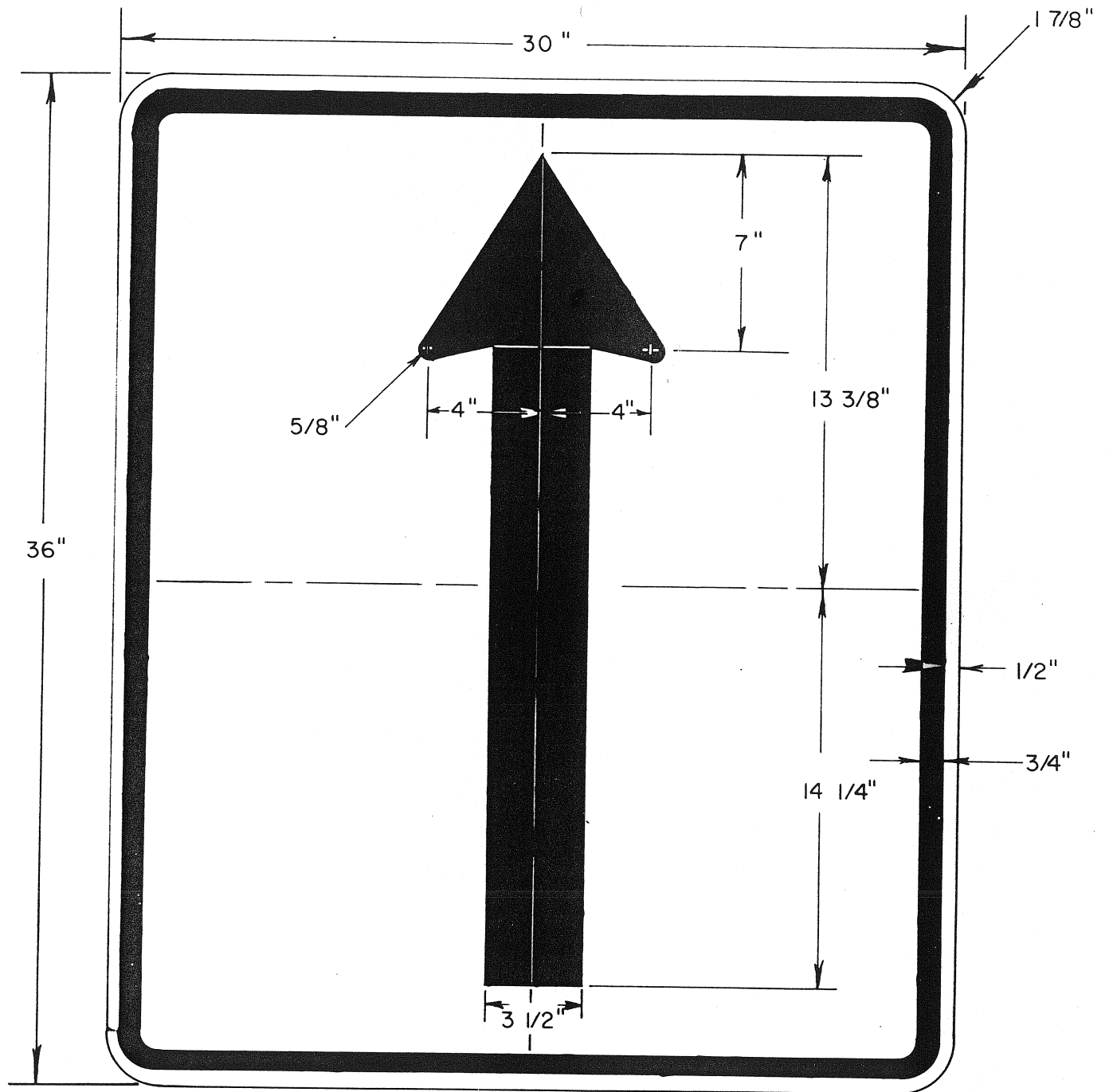

LEGEND - BLACK (NON REFL)
 BACKGROUND - WHITE (REFL)

R3-6a

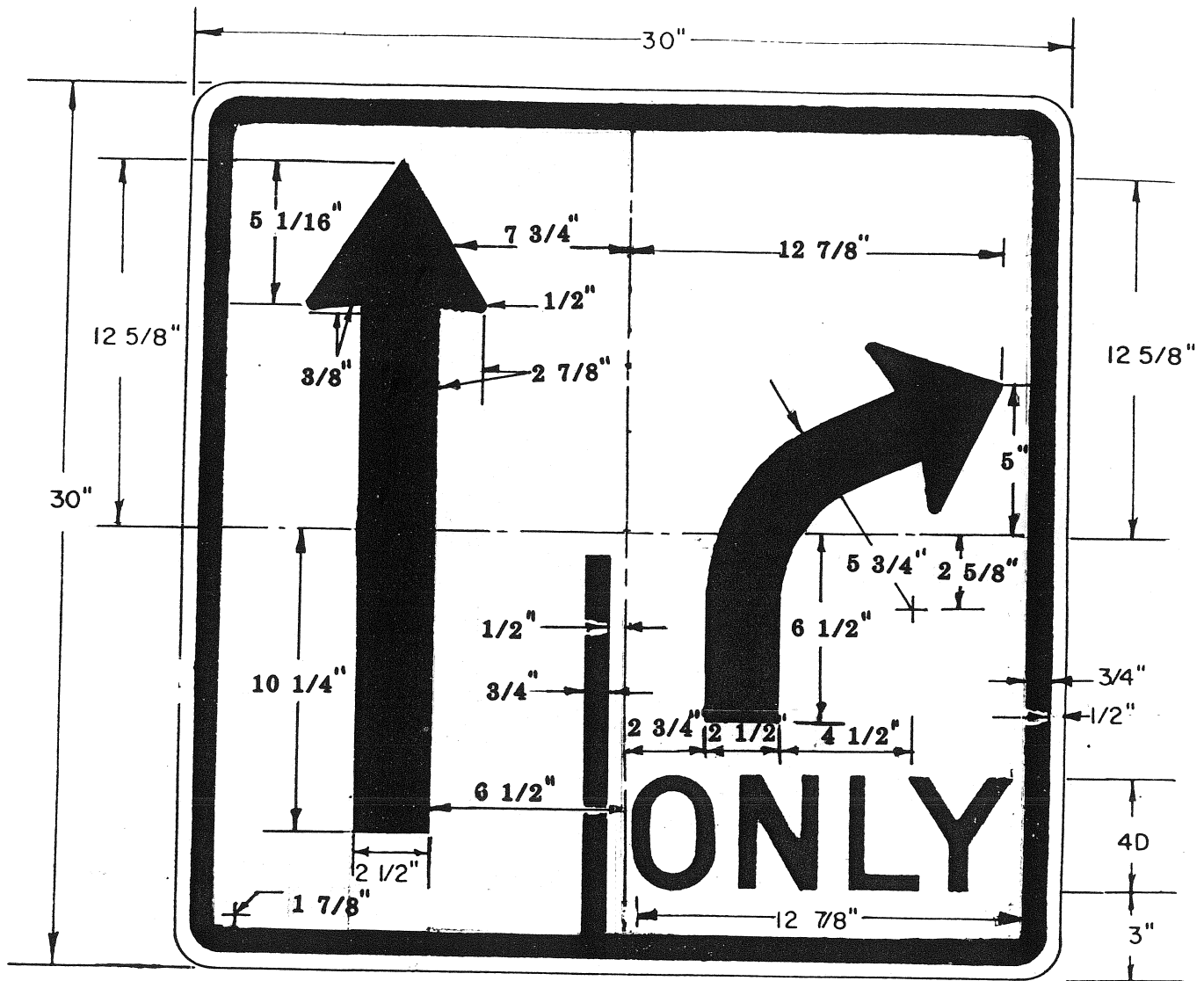

R3-8a

LEGEND - BLACK (NON REFL)
BACKGROUND - WHITE (REFL)

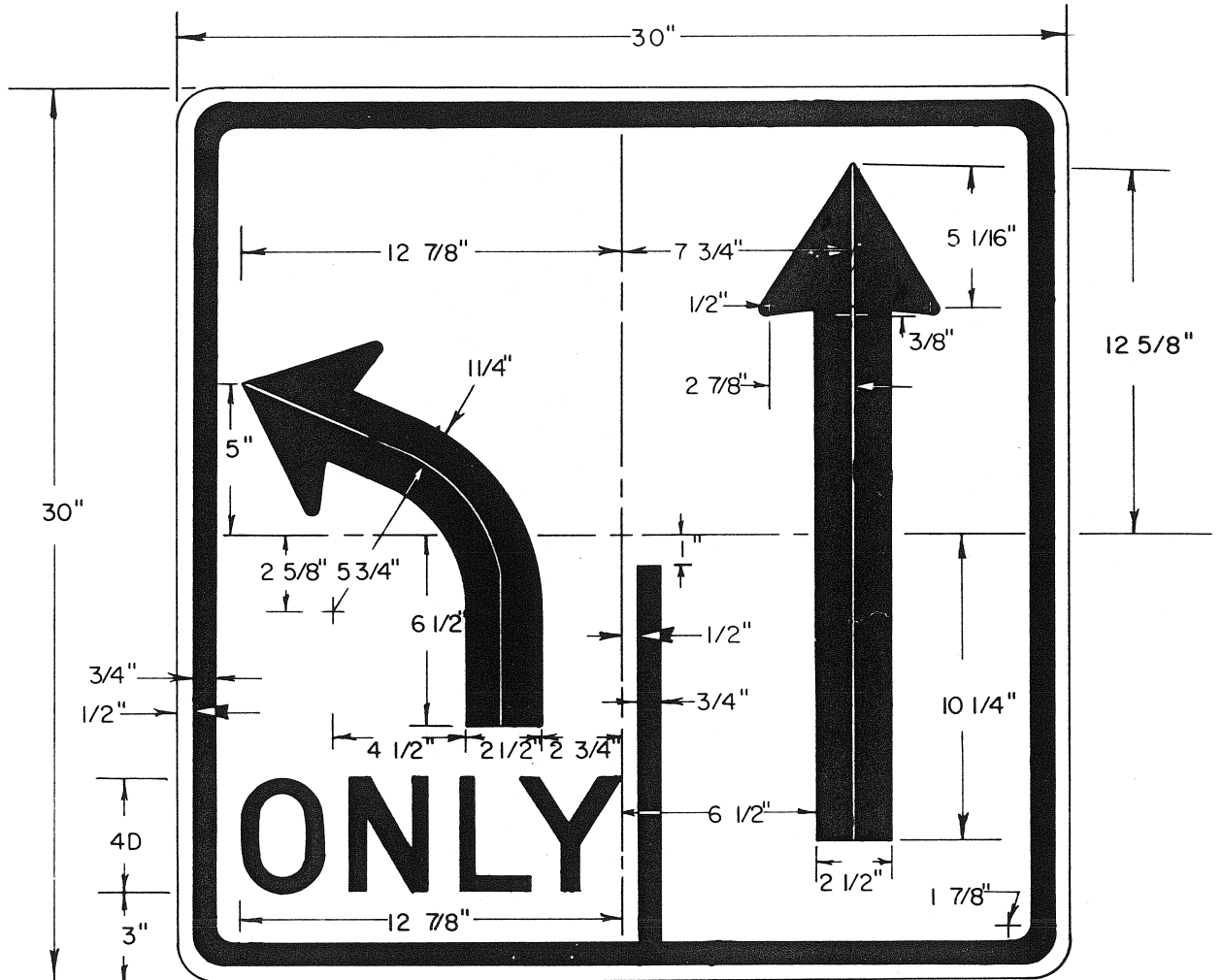

R3-8b

LEGEND - BLACK (NON REFL)
 BACKGROUND - WHITE (REFL)



COLORS
 LEGEND - RED
 BACKGROUND - WHITE

R7-1a

SIGN	DIMENSIONS (INCHES)													
	A	B	C	D	E	F	G	H	I	J	K	L	M	N
MIN. & STD.	12	18	3/8	3/8	2-1/8	3C	1/4	3B	2B	2	4-7/8	3-7/8	4-7/8	1-1/2
SPECIAL	24	36	3/4	3/4	4-1/4	6C	2-1/2	6B	4B	4	9-3/4	7-3/4	9-3/4	3

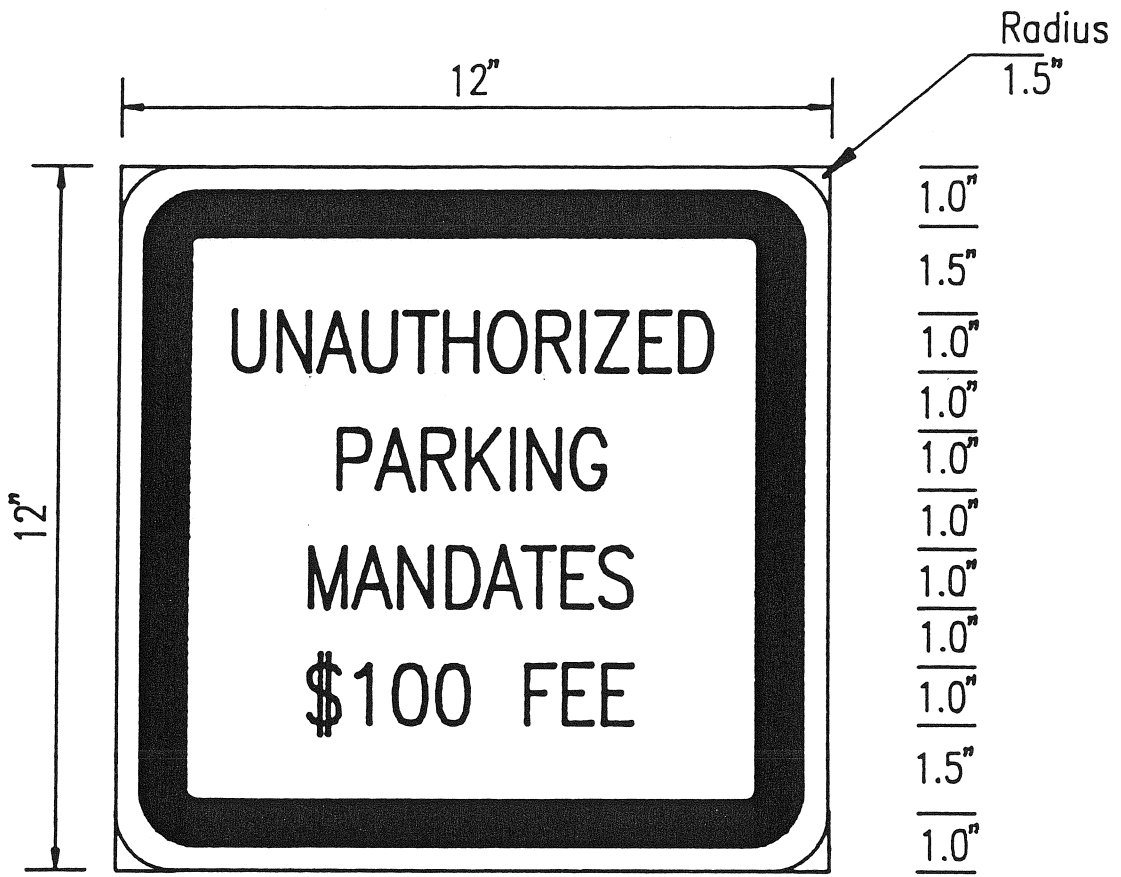

White Background/Black Legend
 Reflectorized

R7-8a-12

1-5a



R7-11a

COLORS

LEGEND - RED
 BACKGROUND - WHITE

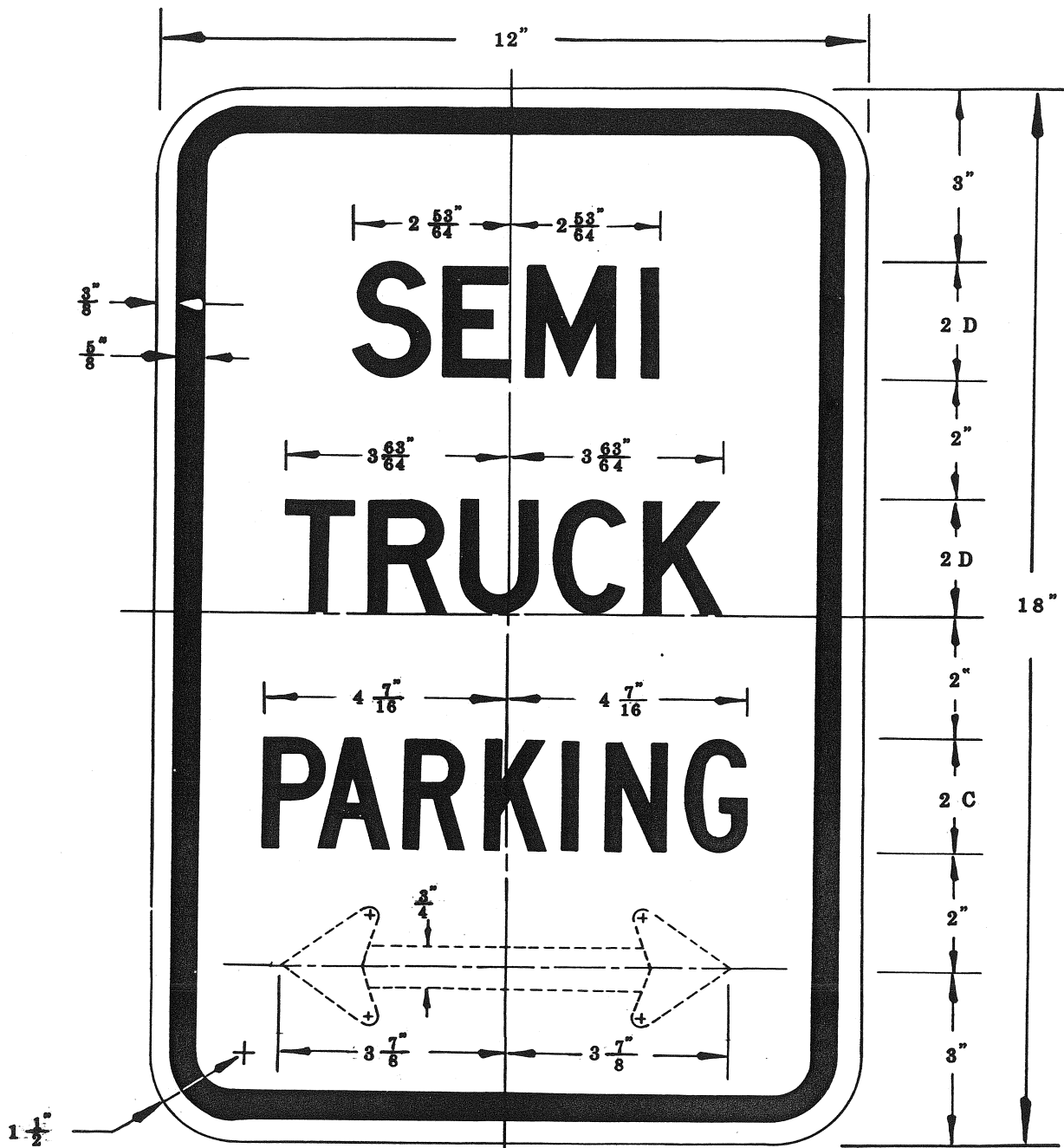

R8-1C

COLORS

LEGEND - GREEN
 BACKGROUND - WHITE

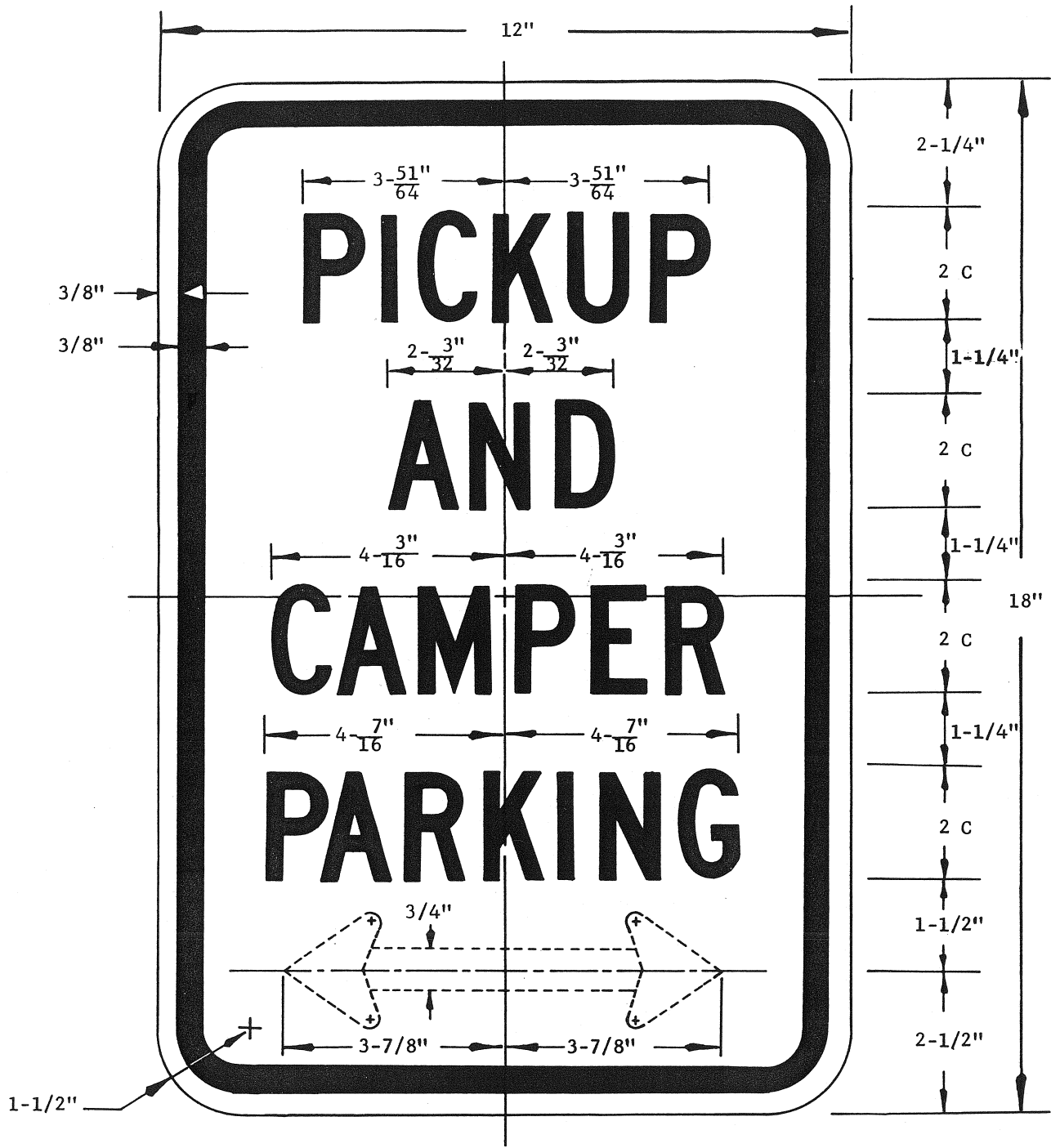

C O L O R S

LEGEND - - - - - GREEN
 BACKGROUND - - - - - WHITE

R 8 - 1 d

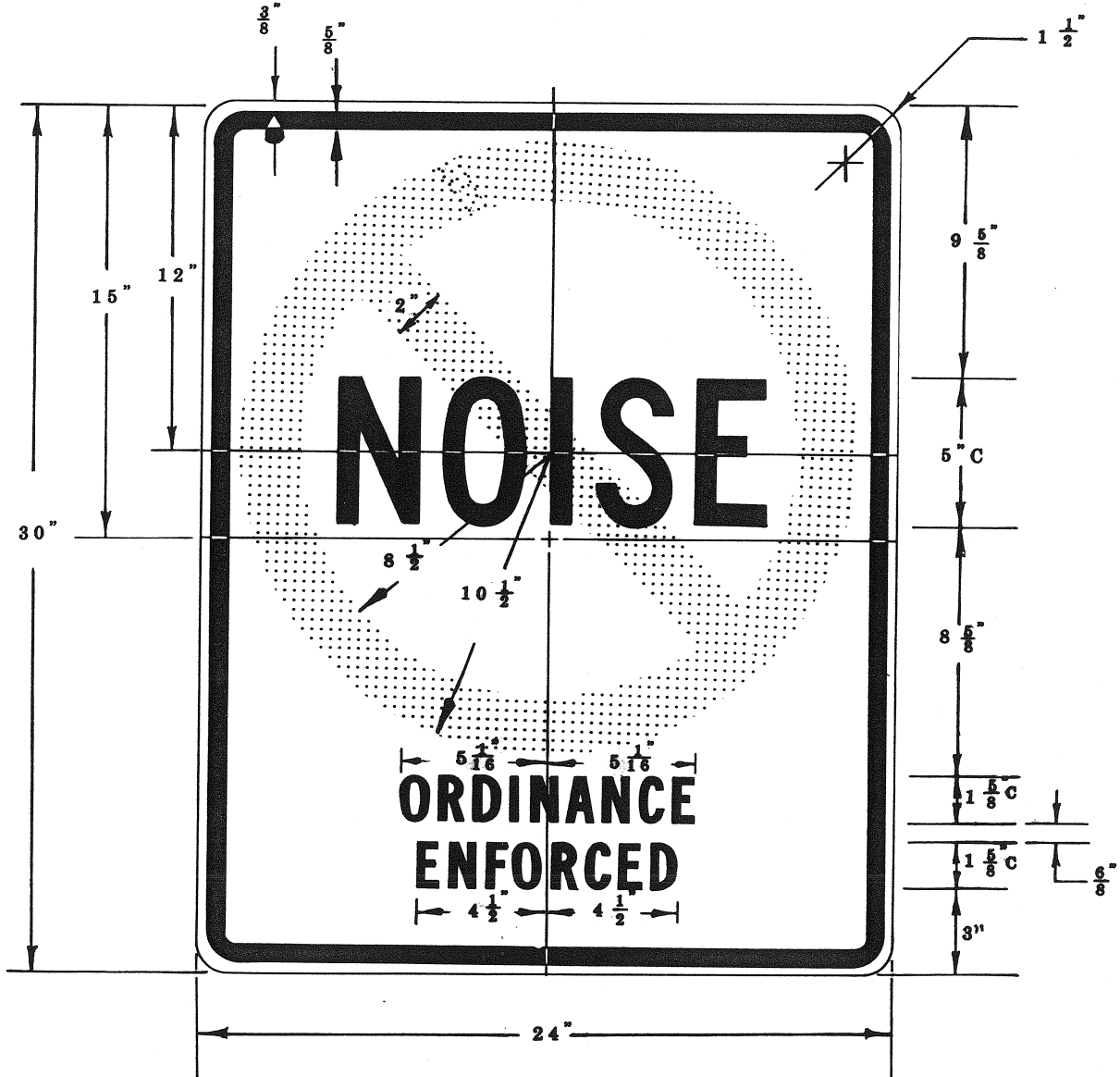

R8-1E-24

COLORS

CIRCLE & DIAGONAL - RED (REFL)
LEGEND AND BORDER - BLACK (NON-REFL)
BACKGROUND - WHITE (REFL)

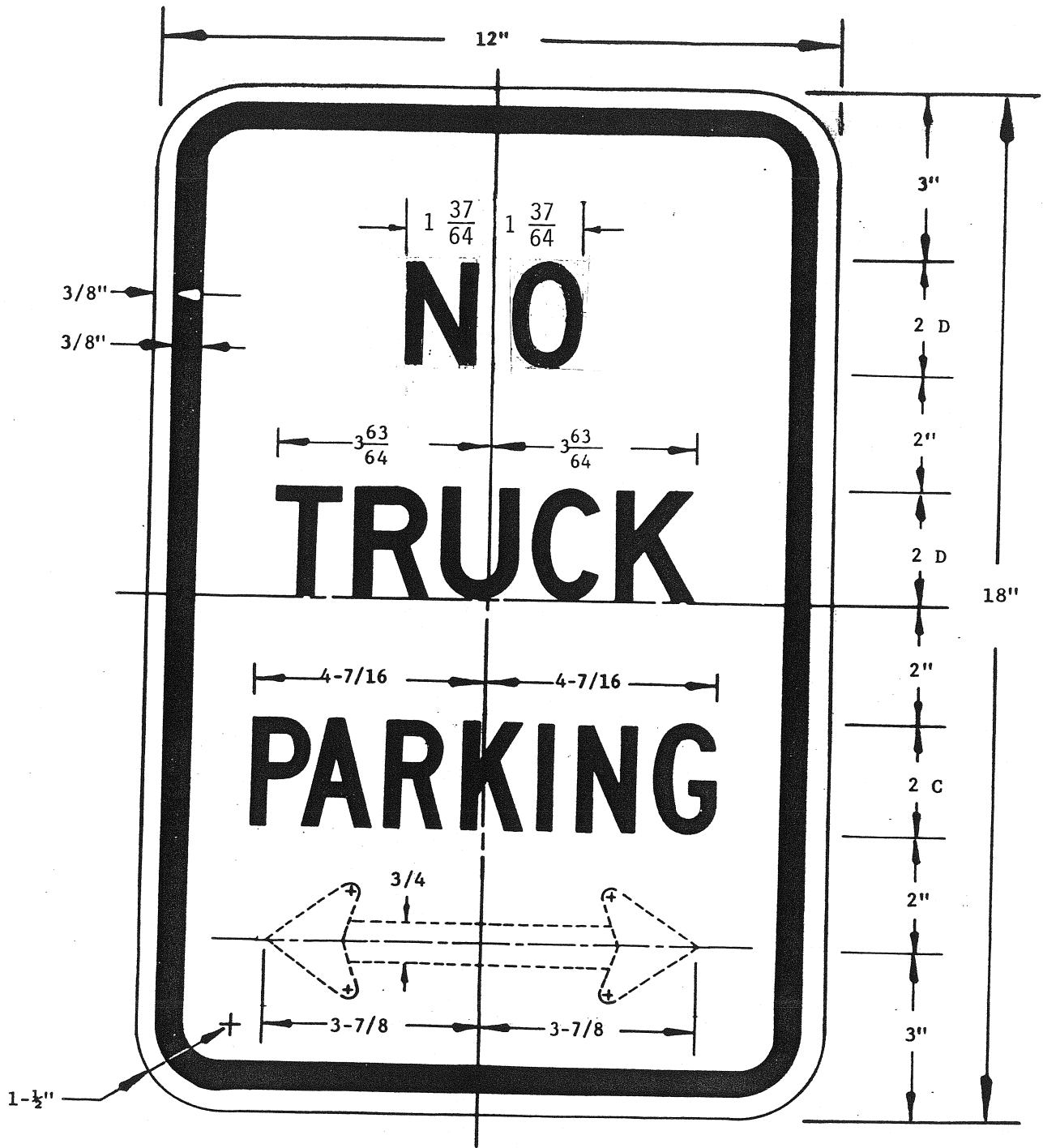

C O L O R S

LEGEND - Red
 BACKGROUND - WHITE

R8-1F



*SPACING HAS BEEN REDUCED 50%

R8-4a
C O L O R S

L E G E N D - BLACK (NON-REFL.)
B A C K G R O U N D - WHITE (REFL.)



SIGN	DIMENSIONS (INCHES)											
	A	B	C	D	E	F	G	H	K	L	M	N
MIN.	36	$\frac{5}{8}$	$\frac{7}{8}$	$3\frac{1}{2}$	6C	4C	3	3	3	$12\frac{22}{64}$	$5\frac{45}{64}$	$7\frac{5}{8}$
SPECIAL	48	$\frac{3}{4}$	$1\frac{1}{4}$	$4\frac{1}{2}$	8C	6C	4	3	5	$16\frac{22}{32}$	$8\frac{5}{16}$	$11\frac{7}{64}$

COLORS

LEGEND - RED (REFL.)
BACKGROUND - WHITE (REFL.)



R9 - 3L

SIGN	DIMENSIONS (INCHES)											
	A	B	C	D	E	F	G	H	K	L	M	N
MIN.	36	5/8	7/8	3-1/2	6c	4c	3	--	3 ⁶³ / ₆₄	12 ⁴⁵ / ₆₄	5 ³⁵ / ₆₄	9 ²¹ / ₃₂
SPECIAL	48	3/4	1-1/4	4-1/2	8c	6c	4	3	5 ⁵ / ₁₆	16 ²³ / ₃₂	8 ⁵ / ₁₆	14 ¹⁵ / ₃₂

C O L O R S

LEGEND - RED (REFL.)
 BACKGROUND - WHITE (REFL.)

SERIES C



BORDER & LEGEND - BLACK (Retro. Refl.)

BACKGROUND - WHITE

R10-5a



R10-11

SIGN	DIMENSIONS (INCHES)											
	A	B	C	D	E	F	G	H	I	J	K	L
SIGNAL POST MOUNTED	36	30	5/8	7/8	7	5C	9	5C	15	15-9/64	8-31/32	1-7/8
MAST ARM MOUNTED	48	36	5/8	7/8	8	6D	8	6D	20-7/16	21-1/8	13-1/16	2-1/4

COLORS

**LEGEND - BLACK (NON-REFL.)
BACKGROUND - WHITE (REFL.)**

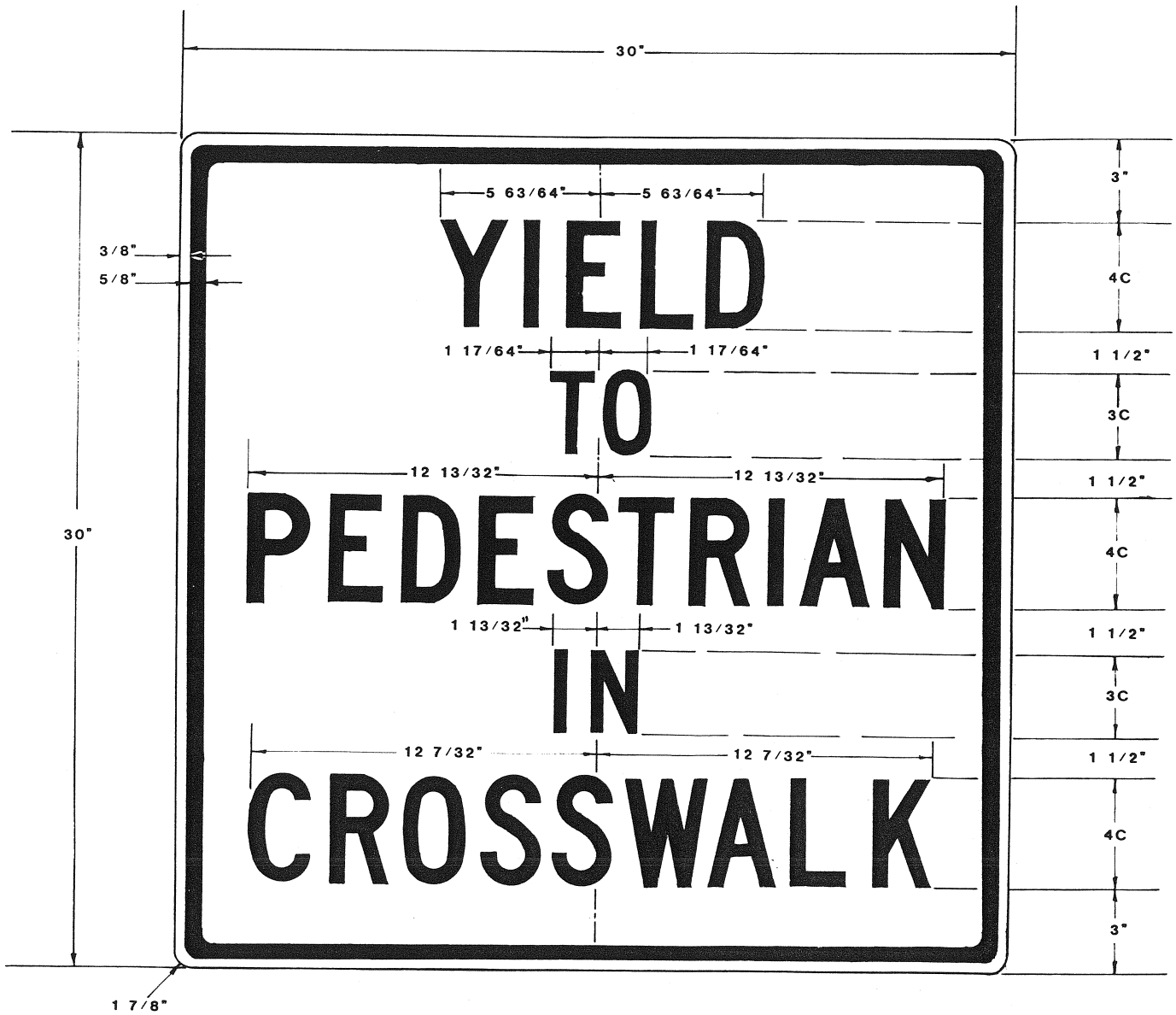

R10-13

LEGEND BLACK (NON-REFL)
BACKGROUND WHITE (REFL)



R-96

COLORS

LEGEND - BLACK (NON-REFL.)
 BACKGROUND - WHITE (REFL.)



R-100

LEGEND BLACK (NON-REFL)

BACKGROUND WHITE (REFL.)



R-101

COLORS

LEGEND - BLACK
BACKGROUND - WHITE

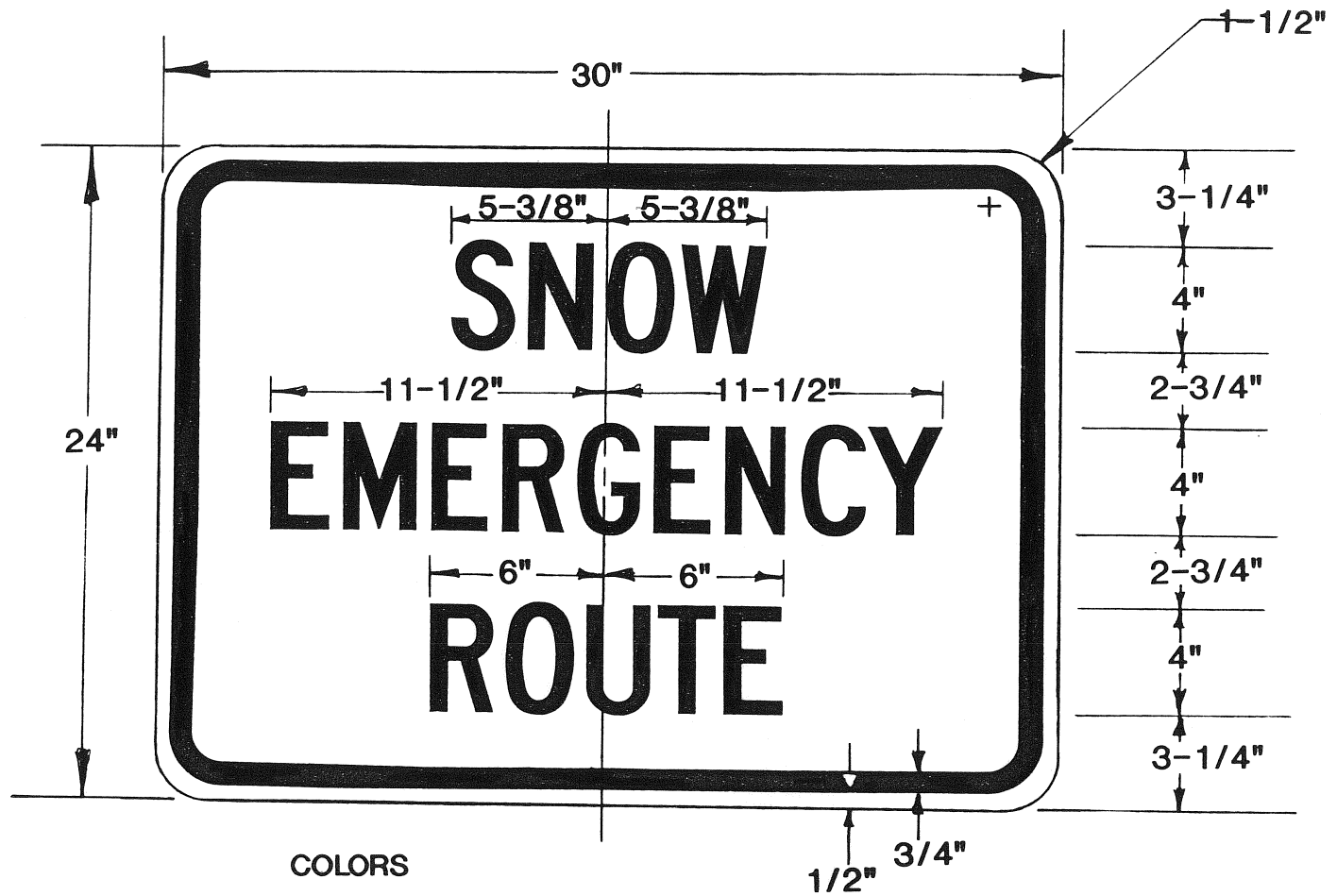

COLORS
 LEGEND BLACK
 BACKGROUND WHITE

R17-1-30

WARNING SIGNS

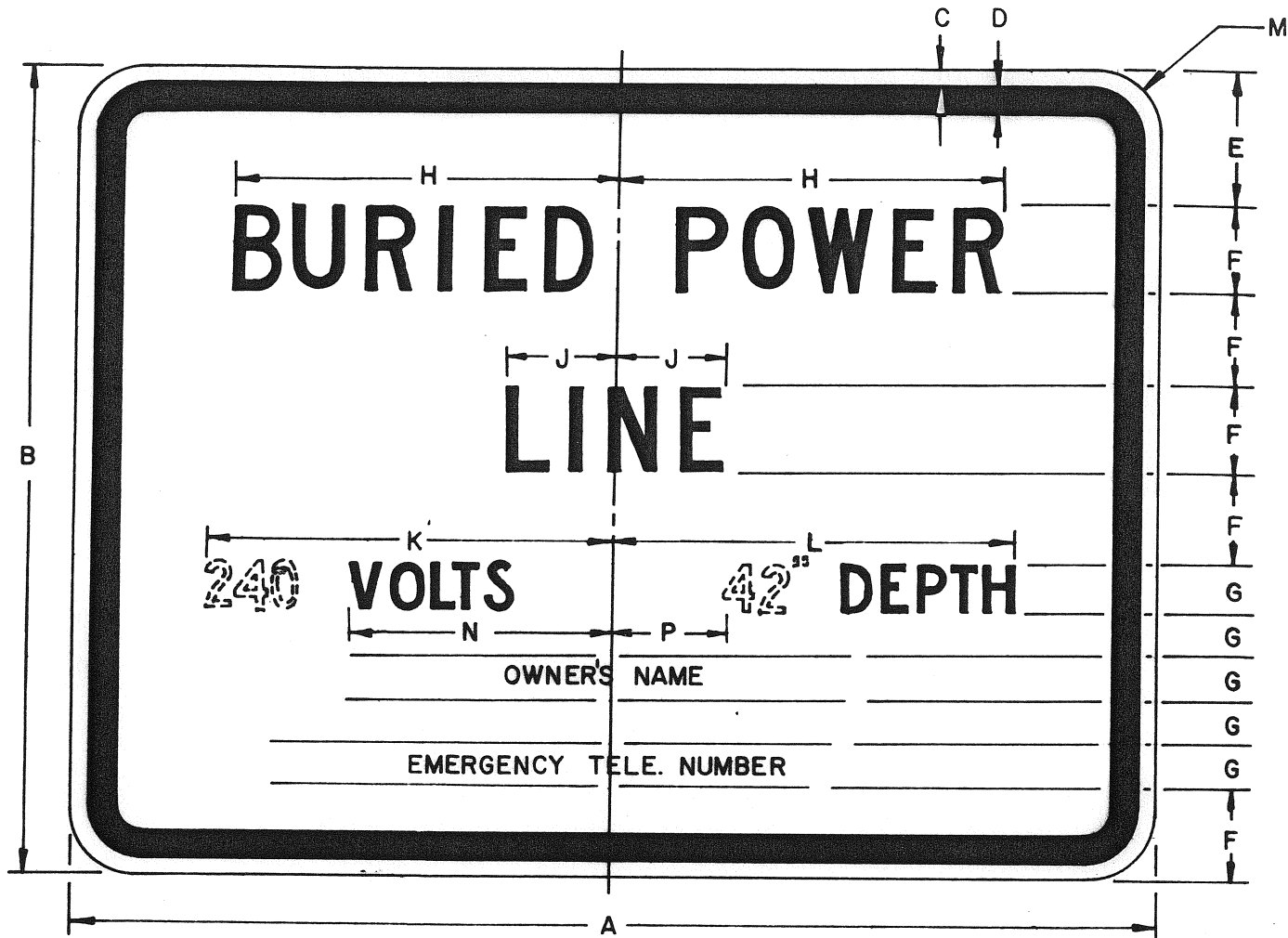

R18-1

SIGN	DIMENSIONS (INCHES)														
	A	B	C	D	E	F	G	H	J	K	L	M	N	P	
STD.	24	18	3/8	5/8	3	2	1	8 1/32	7 7/16	9 3/16	8 13/16	1 1/2	6	3 1/4	

COLORS

LEGEND - BLACK (NON-REFL) Series C
 BACKGROUND - WHITE (REFL)

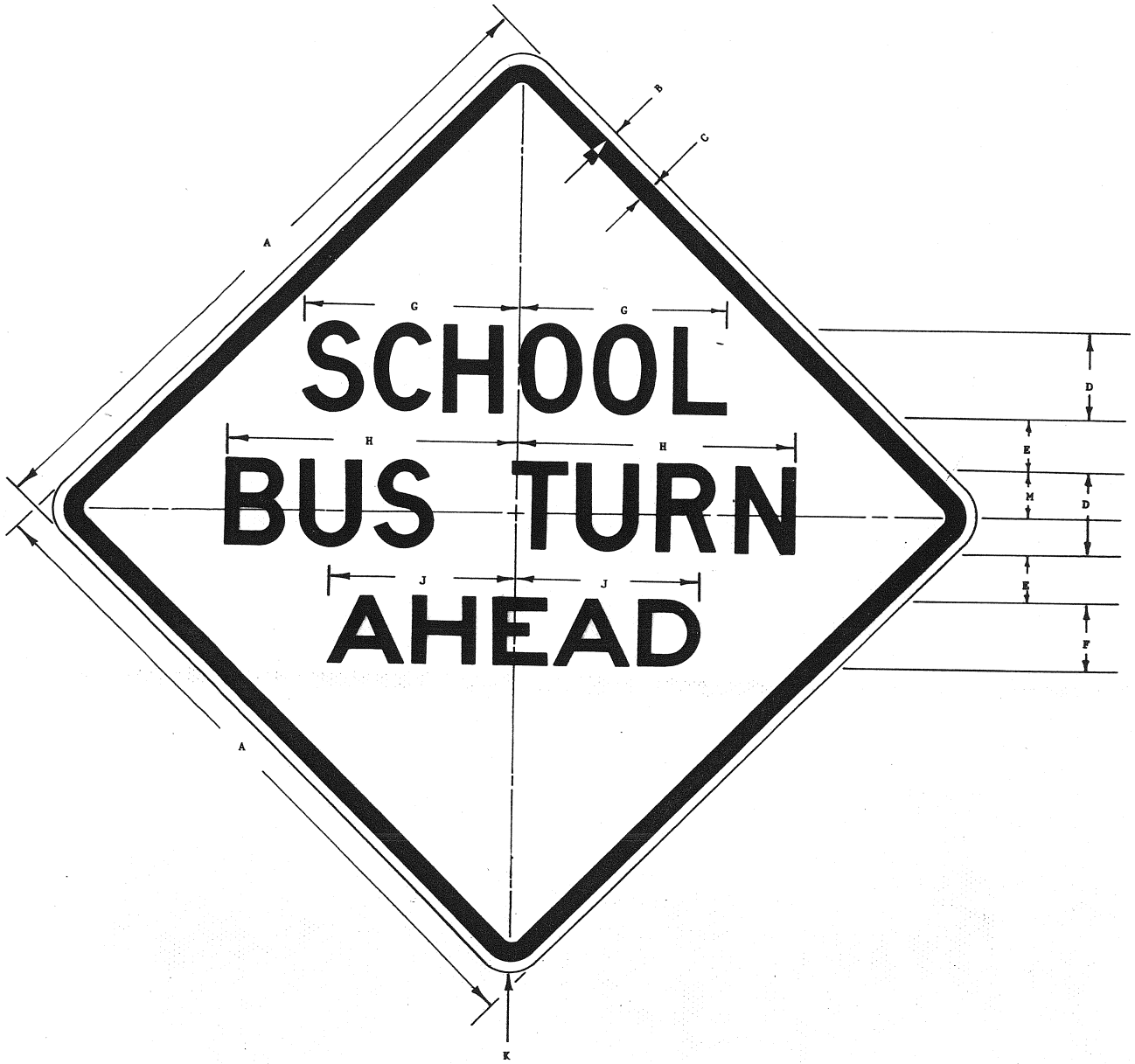

S3-1K

SIGN	DIMENSIONS (INCHES)										
	A	B	C	D	E	F	G	H	J	K	M
MIN.	30	1/2	3/4	4D	2 1/2	3F	10 ³⁹ / ₆₄	14 ¹ / ₆₄	8 3/4	1 7/8	2 1/2
STD.	36	5/8	7/8	5D	3	4F	12 ³⁹ / ₆₄	16 ⁵³ / ₆₄	11 ³ / ₁₆	2 1/4	3
SPECIAL	48	3/4	1 1/4	6D	3 1/2	5F	14 ⁴¹ / ₆₄	19 ²¹ / ₃₂	13 ⁴¹ / ₆₄	3	3 1/2

C O L O R

LEGEND - BLACK
BACKGROUND - YELLOW



S 3-3

SIGN	DIMENSIONS (INCHES)								
	A	B	C	D	E	F	G	H	I
STD	36	5/8	7/8	6C	2-1/2	1-1/4	12-7/16	16-13/16	2-1/4
EXPWY	48	3/4	1-1/4	8C	3	7-1/2	16-0	22-37/64	2

COLORS

**LEGEND - BLACK(NON-REFL.)
BACKGROUND - YELLOW**



W5-2b

SIGN	DIMENSIONS (INCHES)								
	A	B	C	D	E	F	G	H	J
MIN.	30	1/2	3/4	5D	1/8	1 1/2	11 3/8	7 5/32	1 7/8
STD.	36	5/8	7/8	6D	1/4	2	12 9/16	8 5/8	2 1/4
EXPWY.	48	3/4	1 1/4	8D	1/2	2 1/2	19	12 3/8	3

106a

LEGEND BLACK (NON-REFL)
 BACKGROUND YELLOW (REFL)



W 5-2K

SIGN	DIMENSIONS (INCHES)											
	A	B	C	D	E	F	G	H	J	K	L	M
MIN.	24	3/4	5/8	4B	1 5/8	2 3/8	6 5/16	5 7/8	8	1 1/2	6	2
STD.	30	1/2	3/4	5B	2	3	7 7/8	7 3/8	10 7/16	1 7/8	7 1/2	2 1/2
SPECIAL	36	5/8	7/8	6B	2 3/8	3 5/8	9 7/16	8 7/8	12 1/2	2 1/4	9	4 1/2

COLORS
 LEGEND - BLACK (NON-REFL)
 BACKGROUND - YELLOW (REFL)



W5-2L

SIGN	DIMENSIONS (INCHES)										
	A	B	C	D	E	F	G	H	K	L	M
MIN.	36	$\frac{5}{8}$	$\frac{7}{8}$	6C	$2\frac{1}{2}$	4C	$2\frac{1}{4}$	2	$11\frac{15}{64}$	$8\frac{13}{64}$	$4\frac{15}{64}$
SPECIAL	48	$\frac{3}{4}$	$1\frac{1}{4}$	8C	$3\frac{1}{2}$	6C	3	3	$16\frac{17}{64}$	$12\frac{29}{64}$	$6\frac{17}{64}$

COLORS

LEGEND - BLACK
BACKGROUND - YELLOW



W5-2M

LEGEND BACKGROUND BLACK
YELLOW

SIGN	DIMENSIONS (INCHES)									
	A	B	C	D	E	F	G	H	J	K
MIN	36	7/8	5/8	5C	7C	2 1/2	8 1/4	17 3/16	9 1/4	2 1/4
STD	48	1 1/4	3/4	7C	9C	3 1/2	11 5/16	20 11/16	12 11/16	3

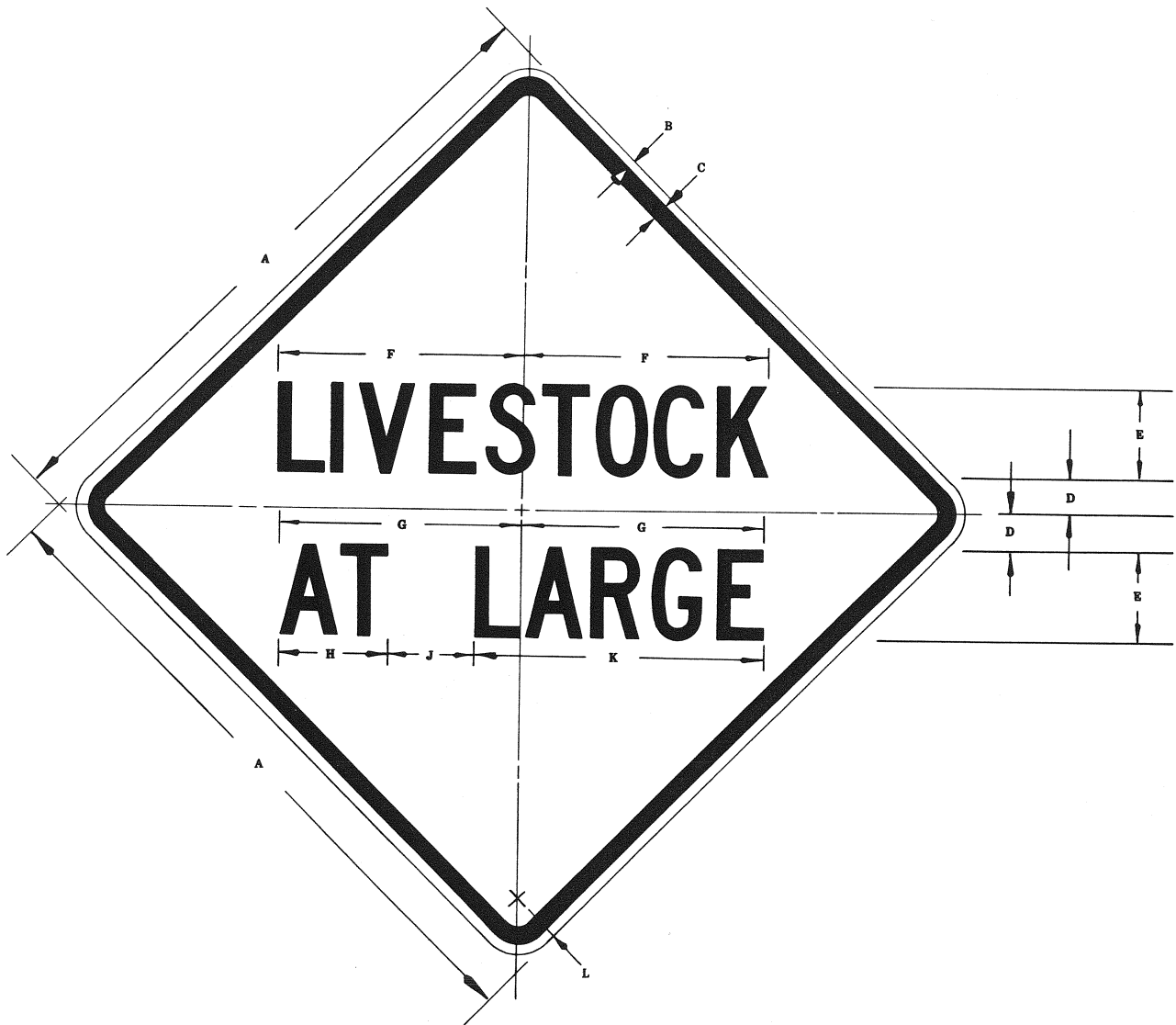

W5-2N

SIGN	DIMENSION (INCHES)										
	A	B	C	D	E	F	G	H	J	K	L
MIN.	30	$\frac{1}{8}$	$\frac{1}{4}$	$1\frac{1}{8}$	4C	11	$6\frac{7}{16}$	$4\frac{2}{16}$	4	$12\frac{7}{8}$	$1\frac{7}{8}$
STD.	36	$\frac{3}{8}$	$\frac{1}{2}$	2	5C	$13\frac{1}{8}$	$12\frac{1}{16}$	$5\frac{3}{4}$	5	$15\frac{1}{4}$	$2\frac{1}{4}$
SPECIAL	48	$\frac{1}{2}$	$1\frac{1}{4}$	$2\frac{1}{8}$	7C	$19\frac{1}{4}$	$18\frac{1}{4}$	8	7	$22\frac{1}{4}$	3

COLORS

LEGEND - BLACK (NON REFL.)
BACKGROUND - YELLOW (REFL.)



W5-20
 SERIES C
 LEGEND - BLACK
 BACKGROUND - YELLOW

SIGN	DIMENSIONS (INCHES)												
	A	B	C	D	E	F	G	H	J	K	L	M	N
MIN	36	7/8	5/8	5C	2 1/2	2 1/2	10 17/64	10 17/64	12 29/64	12 27/64	11 27/64	11 23/64	2 1/4
STD	48	1 1/4	3/4	6C	3 1/2	3 1/2	12	11 15/16	15 3/8	15 5/16	14	13 7/8	3

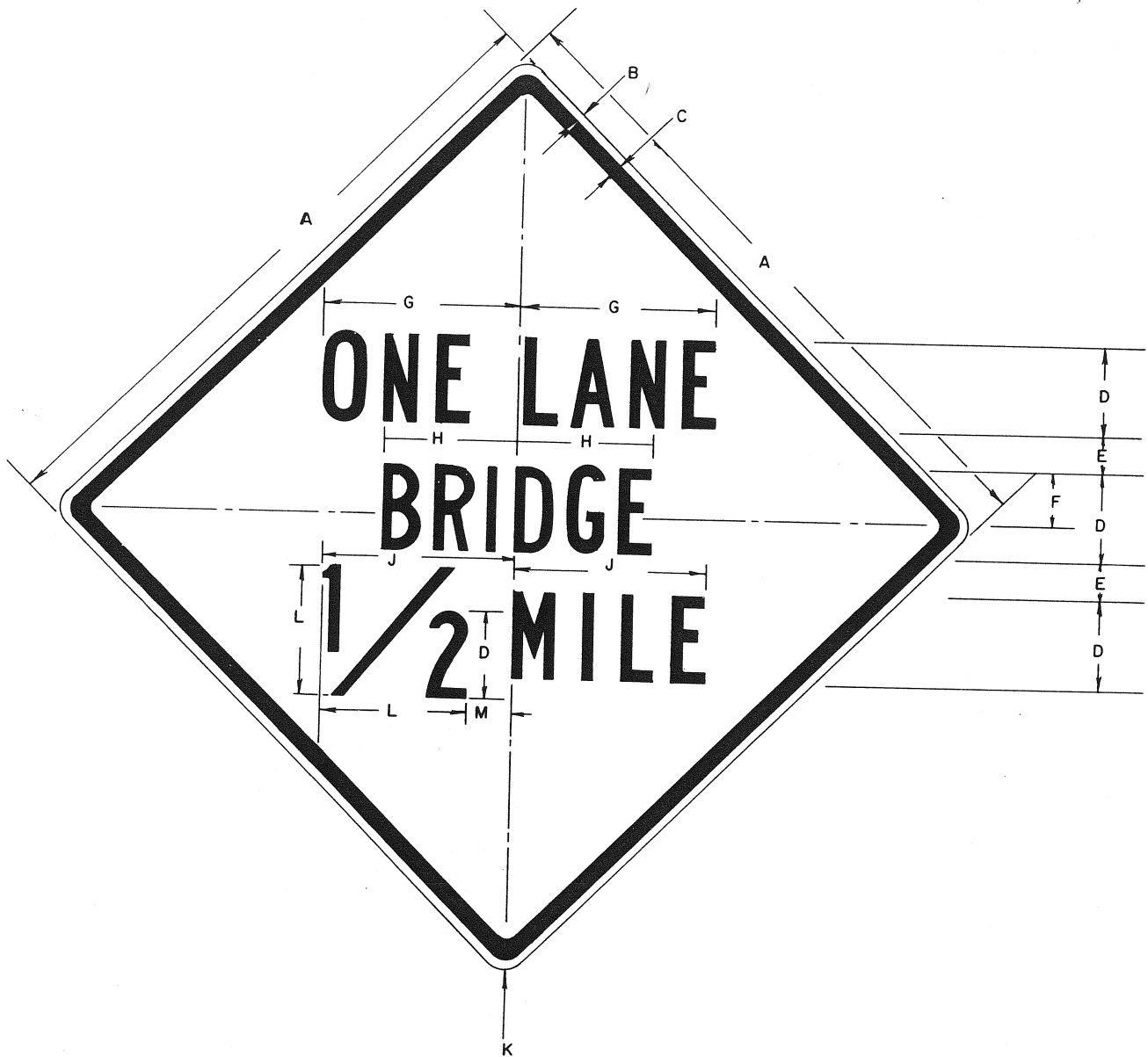

COLORS
 LEGEND - BLACK (NON-REFL.)
 BACKGROUND - YELLOW (REFL.)

W5-3a

SIGN	DIMENSIONS (INCHES)											
	A	B	C	D	E	F	G	H	J	K	L	M
MIN.	24	3/4	5/8	4B	1 5/8	2 3/8	8 5/8	5 7/8	8	1 1/2	6	2
STD.	30	1/2	3/4	5B	2	3	10 7/8	7 3/8	10 7/16	1 7/8	7 1/2	2 1/2
SPECIAL	36	5/8	7/8	6B	2 3/8	3 5/8	13	8 7/8	12 1/2	2 1/4	9	4 1/2

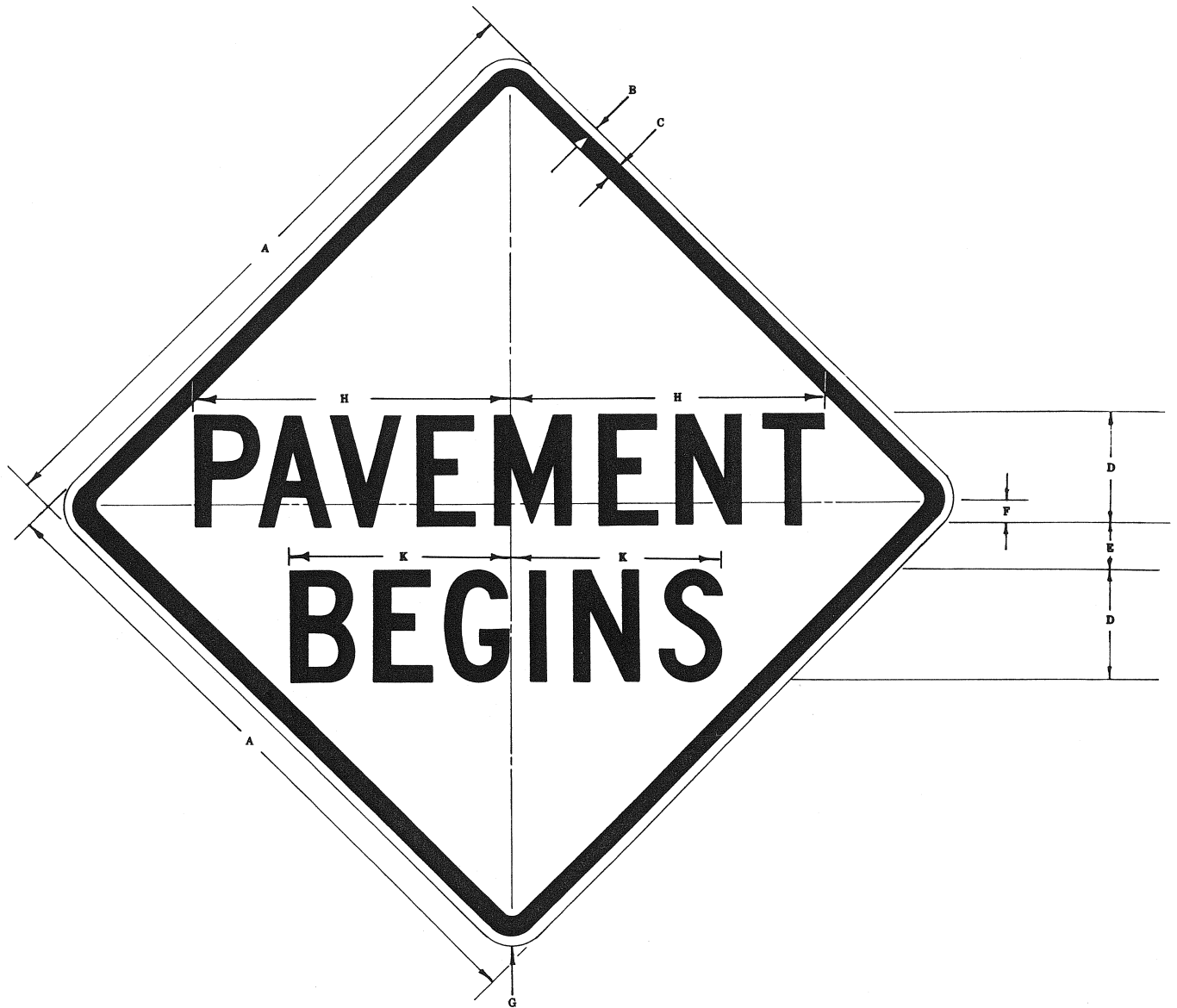

W8-50

LEGEND - BLACK
BACKGROUND - YELLOW

SIGN	DIMENSION (INCHES)									
	A	B	C	D	E	F	G	H	K	
STD	30	$\frac{1}{2}$	$\frac{3}{4}$	5C	3	$\frac{3}{4}$	$1\frac{7}{8}$	$13\frac{15}{16}$	$9\frac{23}{64}$	
EXPWY	36	$\frac{5}{8}$	$\frac{7}{8}$	6C	$3\frac{1}{2}$	1	$2\frac{1}{4}$	$16\frac{3}{4}$	$11\frac{23}{64}$	
FWY	48	$\frac{3}{4}$	$1\frac{1}{4}$	8C	$3\frac{1}{2}$	$1\frac{1}{2}$	3	$21\frac{23}{64}$	$15\frac{9}{64}$	

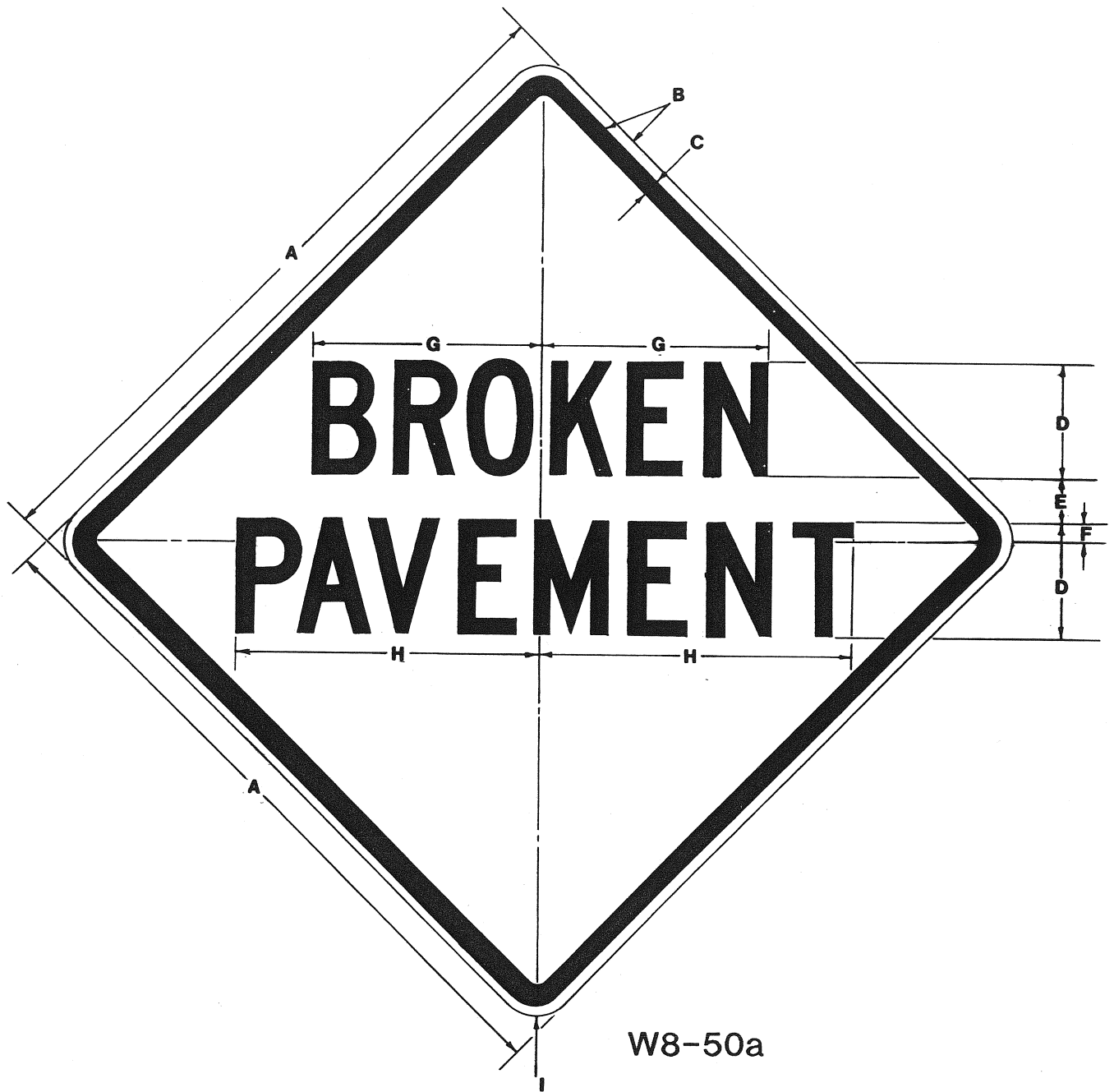

SIGN	DIMENSIONS (INCHES)								
	A	B	C	D	E	F	G	H	I
MIN	30	1/2	3/4	5D	2	1	10-3/8	13-3/8	1-7/8
STD	36	5/8	7/8	6D	2-1/2	1-1/4	12-19/32	16-5/64	2-1/4
EXPWY	48	3/4	1-1/4	8D	3	1-1/2	16-3/32	21-35/64	3

LEGEND BLACK(NON-REFL.)
BACKGROUND YELLOW(REFL.)



SIGN	DIMENSIONS (INCHES)									
	A	B	C	D	E	F	G	H	I	J
MIN	30	1/2	3/4	5C	2	2	8-3/4	12-7/16	9-5/8	2-3/8
STD	36	5/8	7/8	6C	3-3/4	2-3/4	10-1/16	16-3/16	10-1/32	2-1/2
EXPWY	48	3/4	1-1/4	8C	4	3	13-1/2	20-1/2	13-3/8	3

LEGEND BLACK (NON-REFL)
 BACKGROUND YELLOW (REFL)

SIGN NO. W8-12

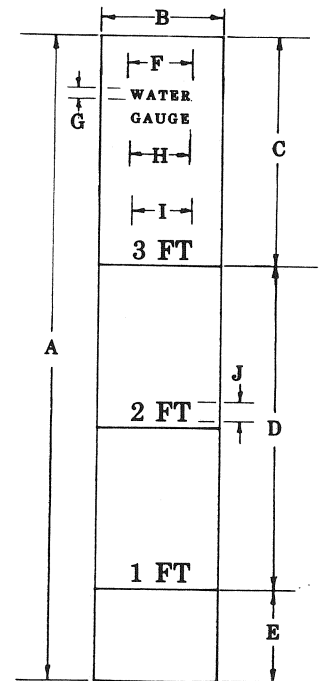

GAUGE BOARD
 Size
 9 X 48

SIGN	DIMENSIONS (INCHES)									
	A	B	C	D	E	F	G	H	I	J
STD	48	9	18	24	6	6 13/16	2C	6 37/64	6 25/64	3C

LEGEND BLACK (NON-REFL)
 BACKGROUND YELLOW (REFL)

SIGN NO. W8-13



W8-58

SIGN	DIMENSIONS (INCHES)										
	A	B	C	D	E	F	G	H	J	K	L
MIN.	36	7/8	5/8	4 7/8	8 5/8	12 1/16	5C	4	23	2	2 1/4
STD.	48	1 1/4	3/4	6 3/4	12 3/16	16 3/4	7C	4	29	2	3

COLORS

LEGEND- BLACK
BACKGROUND - YELLOW



W10-1K

SIGN	DIMENSIONS (INCHES)																	
	A	B	C	D	E	F	G	H	I	J	K	L	M	N	O	P	Q	
STD.	30	1/2	3/4	3-9/16	5D	1-7/8	7-3/4	5-3/4	4-3/8	11-1/8	10-3/4	1-7/8	1-7/8	2-3/16	1/4	3/8	3-13/16	
EXPWY.	36	5/8	7/8	4-5/16	6D	2-1/4	9-5/16	6-7/8	5-1/4	13-5/16	12-15/16	2-1/4	2-1/4	2-5/8	5/16	7/16	4-9/16	
SPECIAL	48	3/4	1-1/4	5-3/4	8D	3	12-7/16	9-3/16	7	17-3/4	17-1/4	3	3	3-1/2	7/16	9/16	6-1/8	

COLORS

REVISED 2-14-1978

LEGEND- BLACK (NON-REFL.)
BACKGROUND- YELLOW (REFL.)

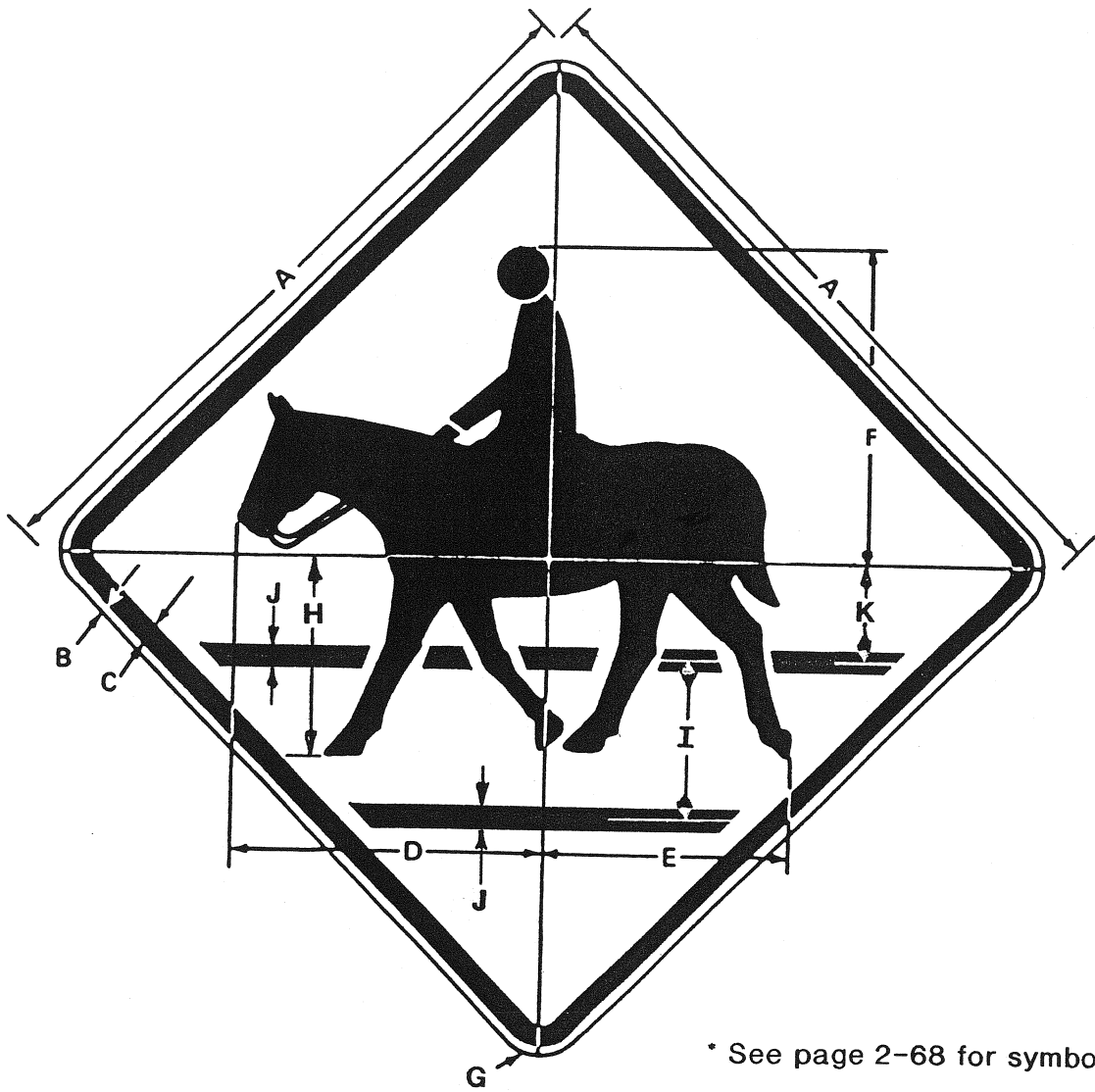

* See page 2-68 for symbol design.

W11-7a

SIGN	DIMENSIONS (INCHES)										
	A	B	C	D	E	F	G	H	I	J	K
MIN.	24	3/8	5/8	10-1/2	8	10-5/8	1-1/2	6-11/16	4-3/4	5/8	3-1/8
STD.	30	1/2	3/4	13	10	13	1-7/8	8-3/16	6	3/4	4
SPECIAL	36	5/8	7/8	15-1/2	12	15-5/8	2-1/4	9-27/32	7-1/4	7/8	4-3/4
SPECIAL	48	3/4	1-1/4	21	16	21	3	13-7/32	9-1/2	1-1/4	6-1/4

COLORS

LEGEND -BLACK (NON-REFL)
BACKGROUND-YELLOW (REFL)



W11-7d

SIGN	DIMENSIONS (INCHES)									
	A	B	C	D	E	F	G	H	I	J
MIN.	30	$1\frac{5}{32}$	$2\frac{25}{32}$	4C	$2\frac{1}{2}$	2	$8\frac{25}{32}$	5	$8\frac{15}{16}$	$1\frac{13}{32}$
STD.	36	$\frac{9}{16}$	$1\frac{5}{16}$	5C	3	$2\frac{1}{2}$	$10\frac{9}{16}$	6	$10\frac{3}{4}$	$1\frac{11}{16}$
EXPWY.	48	$\frac{3}{4}$	$1\frac{1}{4}$	7C	4	$3\frac{1}{2}$	$14\frac{1}{16}$	8	$14\frac{5}{16}$	$2\frac{1}{4}$

COLORS

LEGEND - BLACK (NON REFL.)
 BACKGROUND - YELLOW (REFL.)

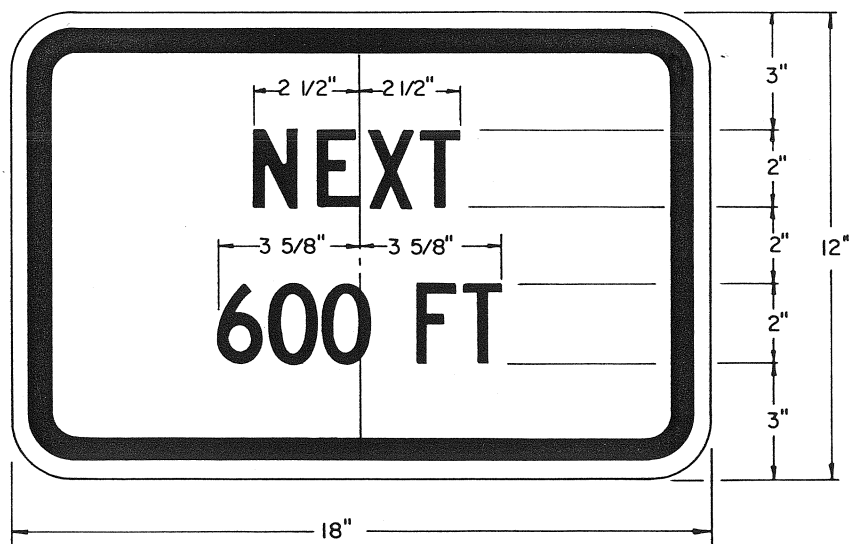
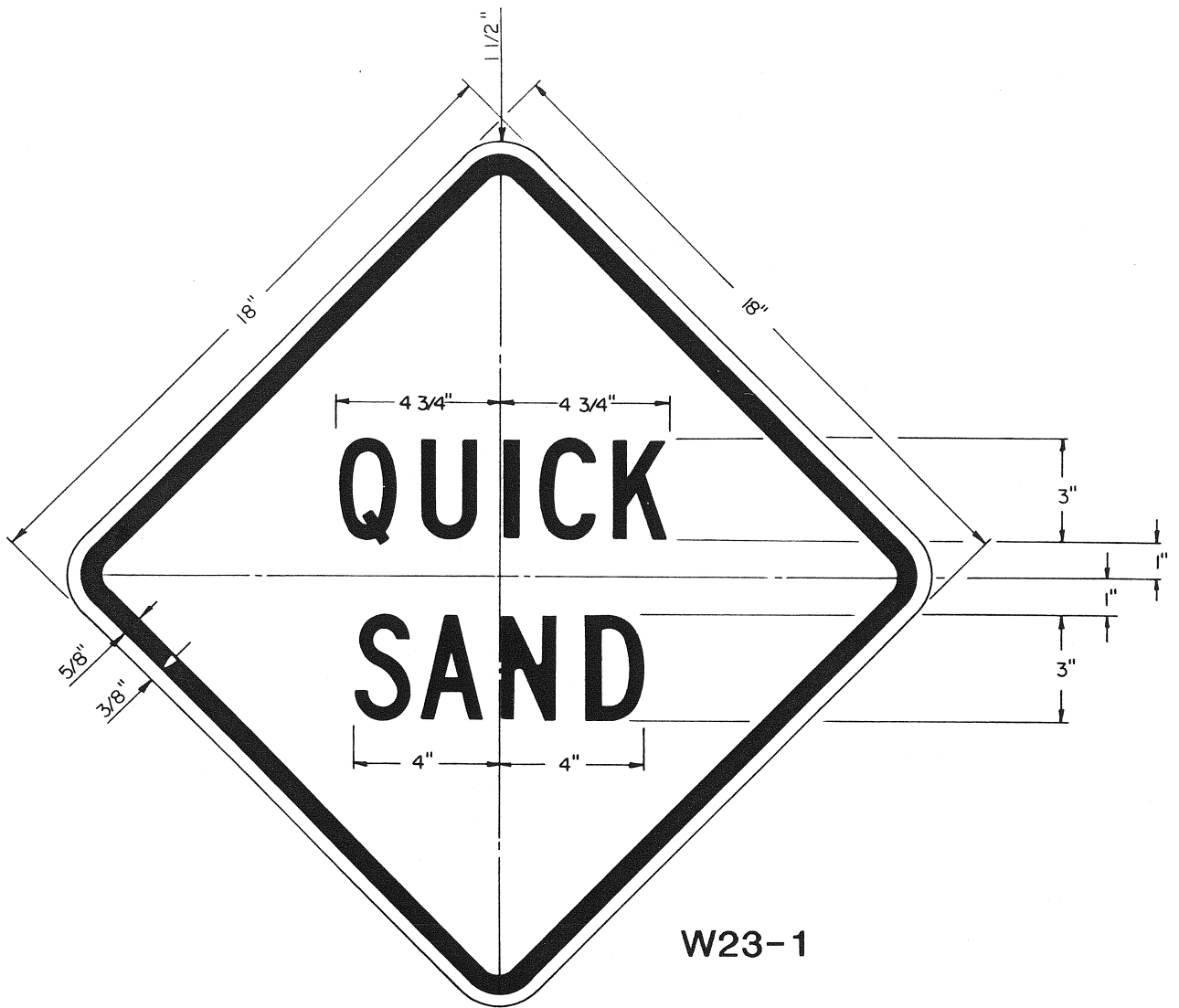

W23-1a
 COLORS
 LEGEND-BLACK (NON REFL.)
 BACKGROUND-YELLOW (REFL.)
 SERIES-C

GUIDE SIGNS

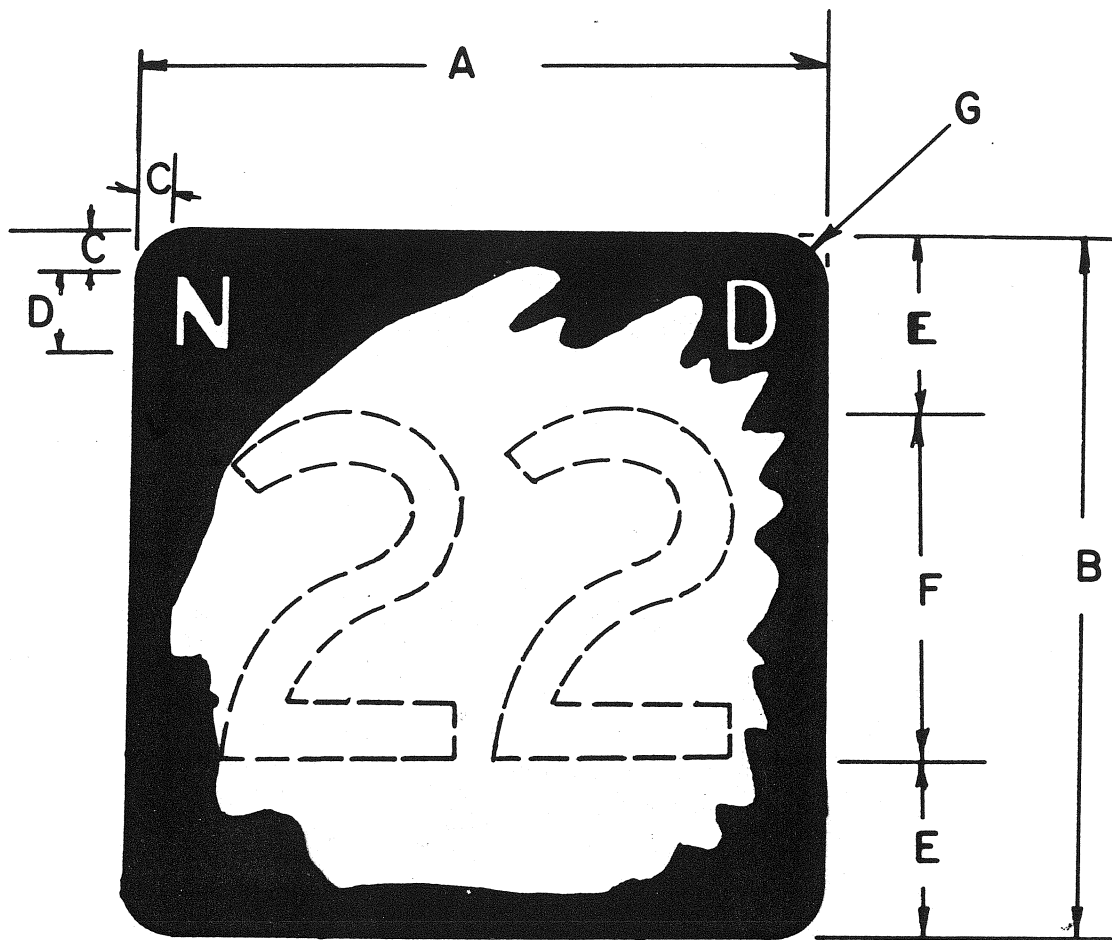

M1-5

**STATE ROUTE MARKER
(FOR INDEPENDENT USE)**

SIGN	DIMENSION (INCHES)						
	A	B	C	D	E	F	G
1 & 2 Digits	24	24	1 3/8	3 E	6	12 D	1 1/2
3 Digits	30	24	1 3/8	3 E	6	12 D	1 1/2

**COLORS
LEGEND - BLACK (NON REFL)
BACKGROUND - WHITE (REFL)**

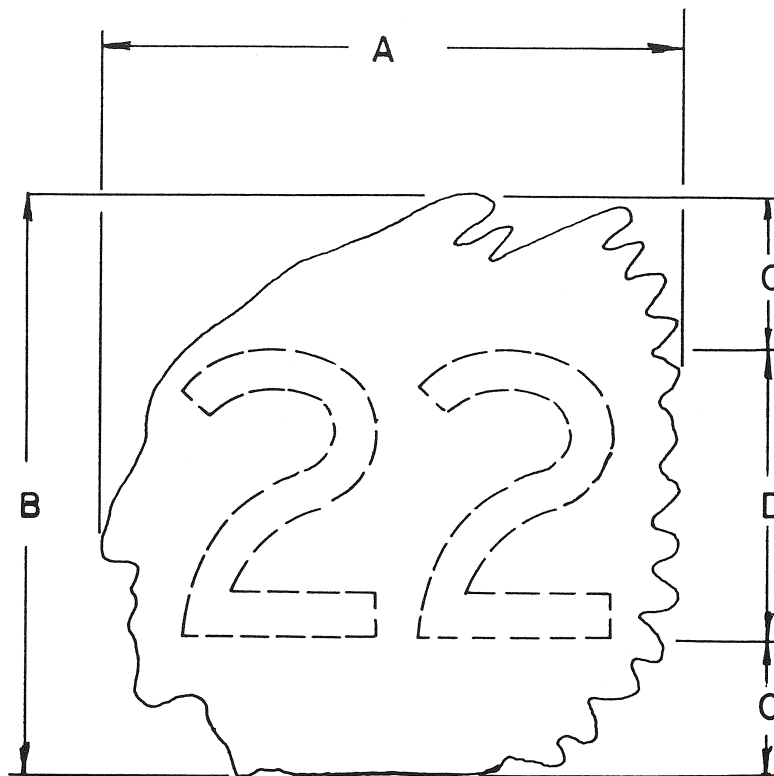

M1-5A STATE ROUTE MARKER
(FOR GUIDE SIGN USE)

SIGN	DIMENSIONS (INCHES)			
	A	B	C	D
1 & 2 Digits	24	24	6	12 D
1 & 2 Digits	36	36	9	18 D
1 & 2 Digits	48	48	12	24 D
3 Digits	30	24	6	12 D
3 Digits	45	36	9	18 D
3 Digits	60	48	12	24 D

COLORS

LEGEND - BLACK (NON. REFL)
BACKGROUND - WHITE (REFL)



M1 - 95

SYMBOL

C O L O R S

WHITE	=	YELLOW
BLACK	=	BLUE

C O L O R S

LEGEND	-	BLUE
BACKGROUND	-	WHITE



M1-97

COLORS

LEGEND - BLACK
 BACKGROUND - BLUE (REFL.)
 SYMBOL & BORDER WHITE(REFL.)



M1-112
 SERIES E

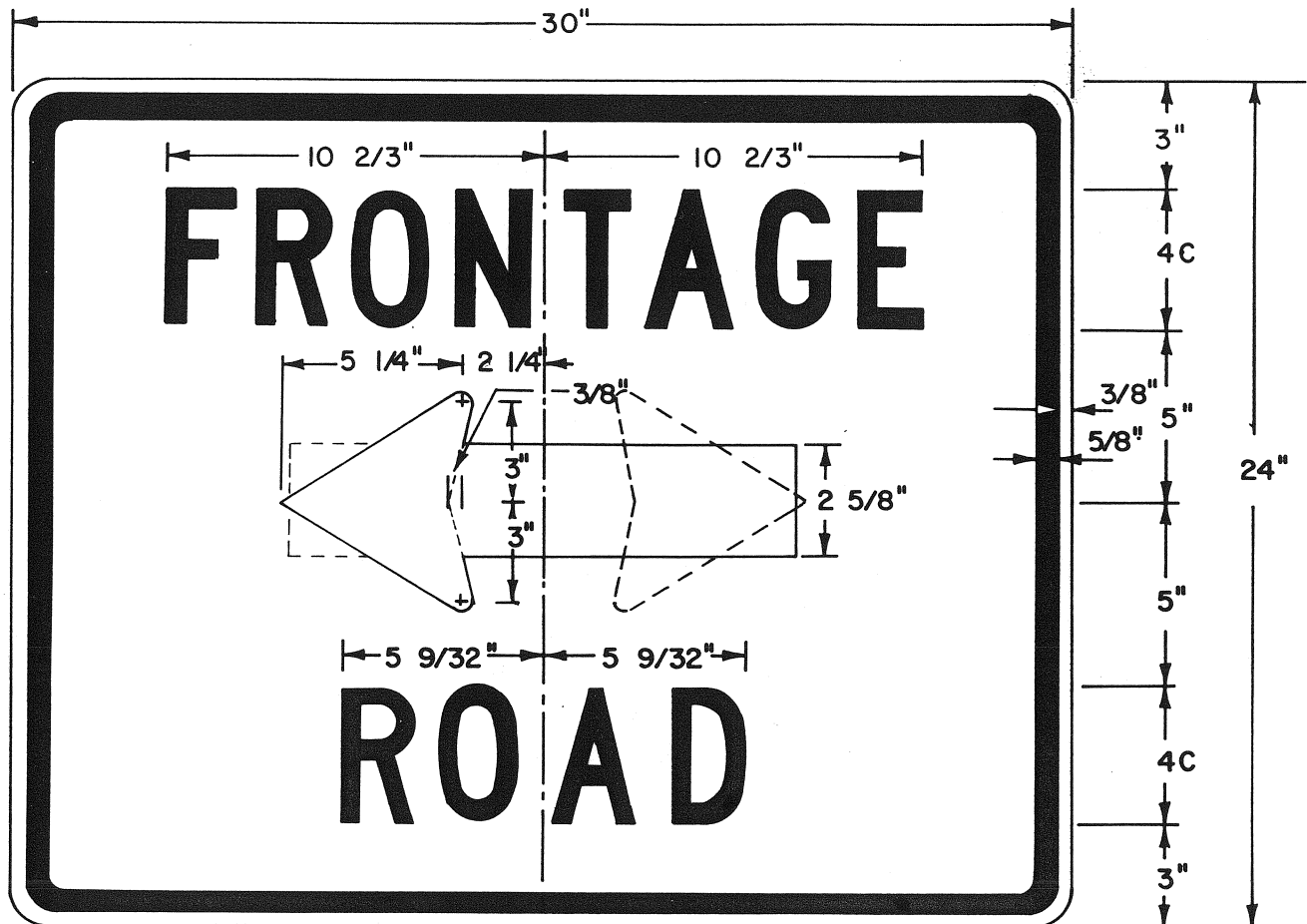

(← = N, → = O, ↔ = P)

LEGEND BLACK (NON-REFL.)
BACKGROUND WHITE (REFL.)

M6-7P

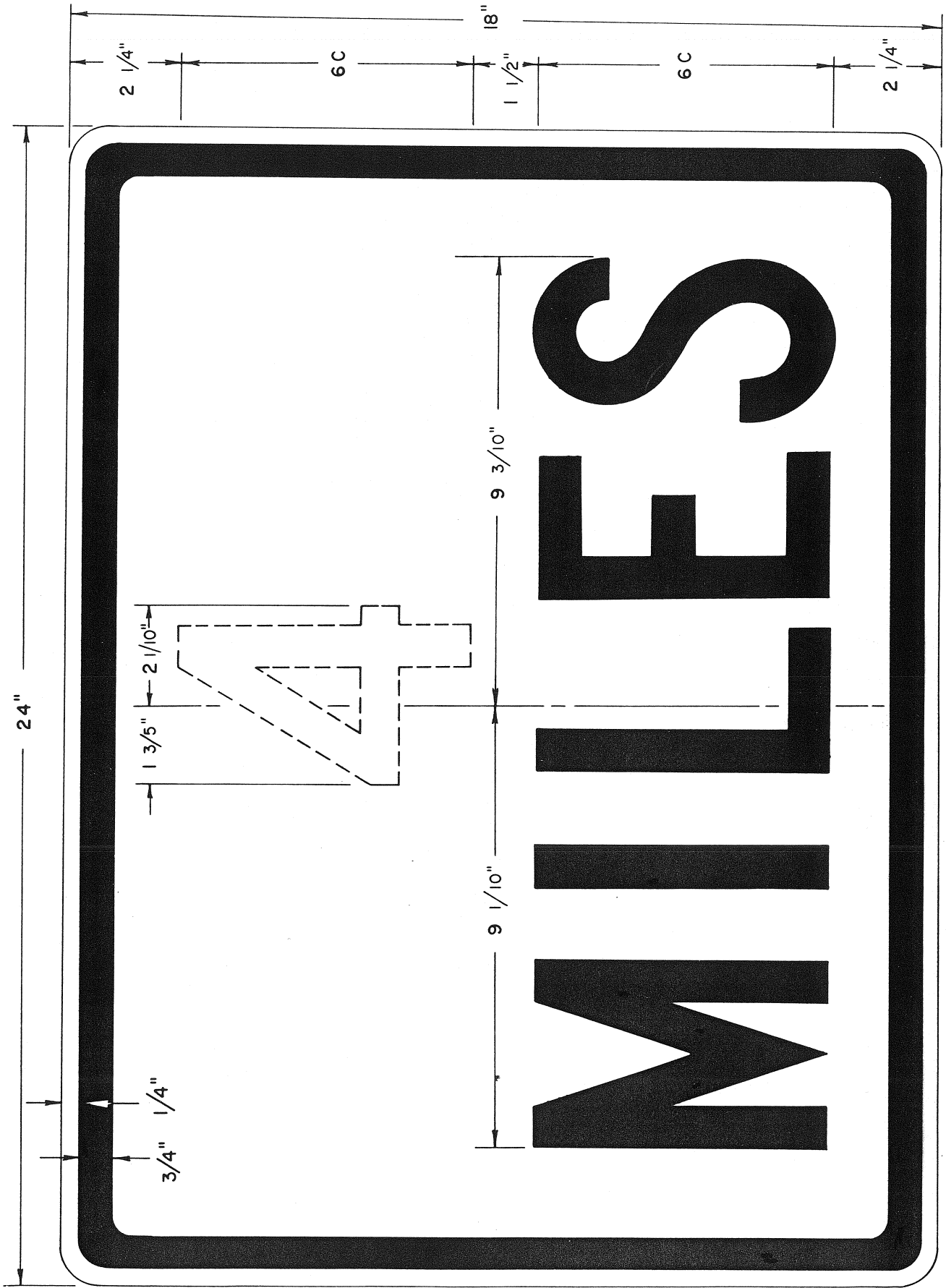

M6-11
 LEGEND BLACK (NON-REFL.)
 BACKGROUND WHITE (REFL.)

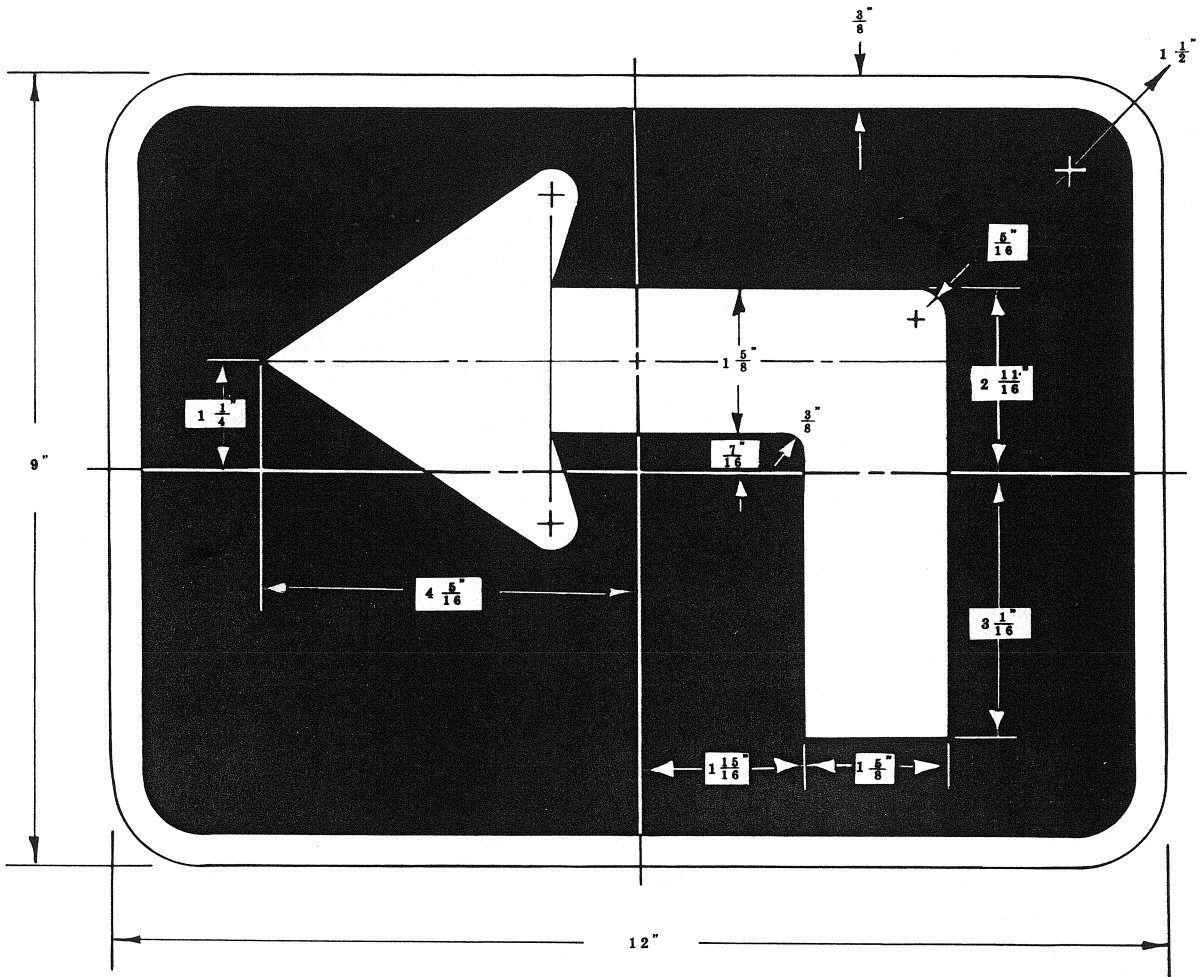

M7-8

COLORS

LEGEND - WHITE (REFL.)

BACKGROUND - GREEN (REFL.)

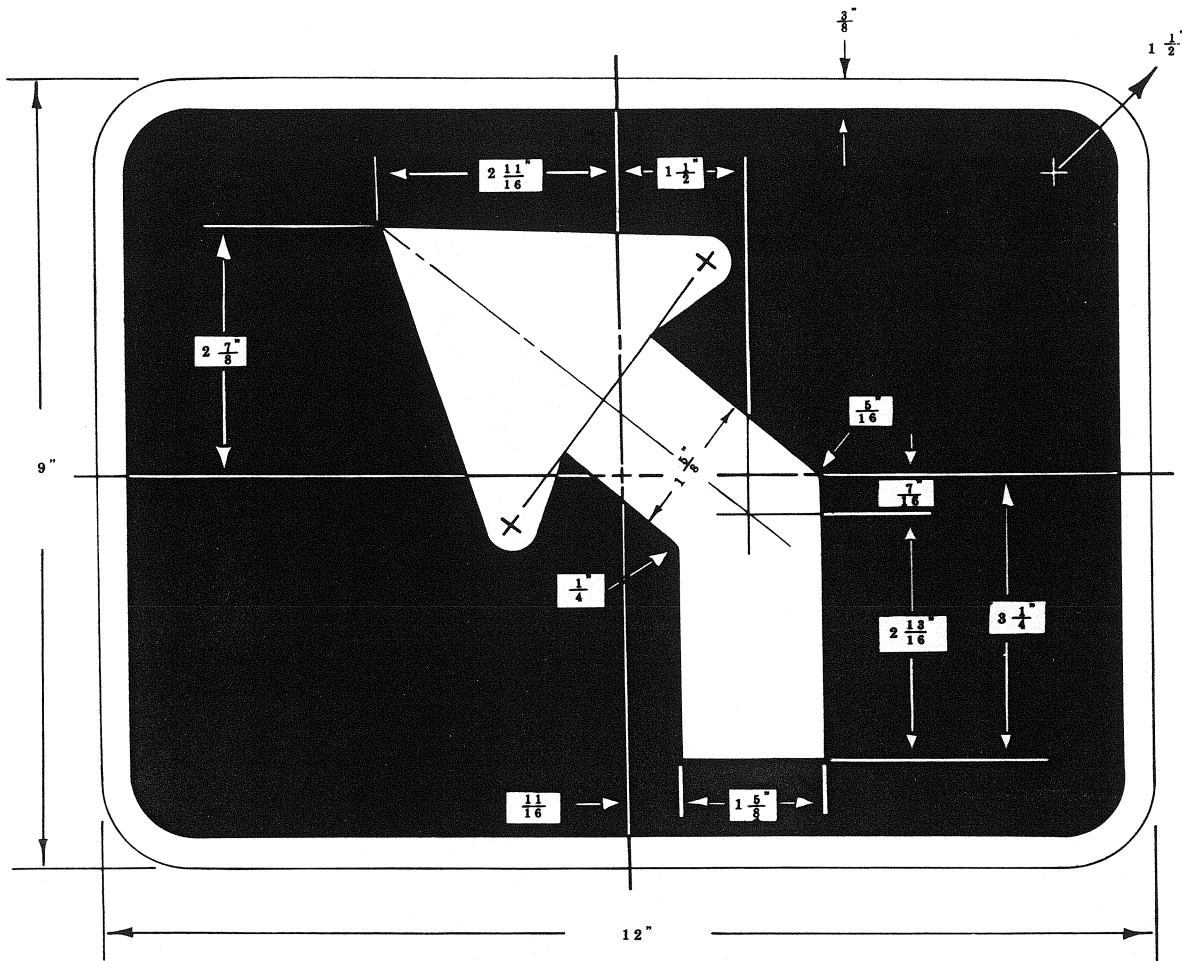

M7-11

COLORS
 LEGEND - WHITE (REFL.)
 BACKGROUND - GREEN (REFL.)



RG-090

COLORS
LEGEND - WHITE(REFL)
BACKGROUND-BROWN

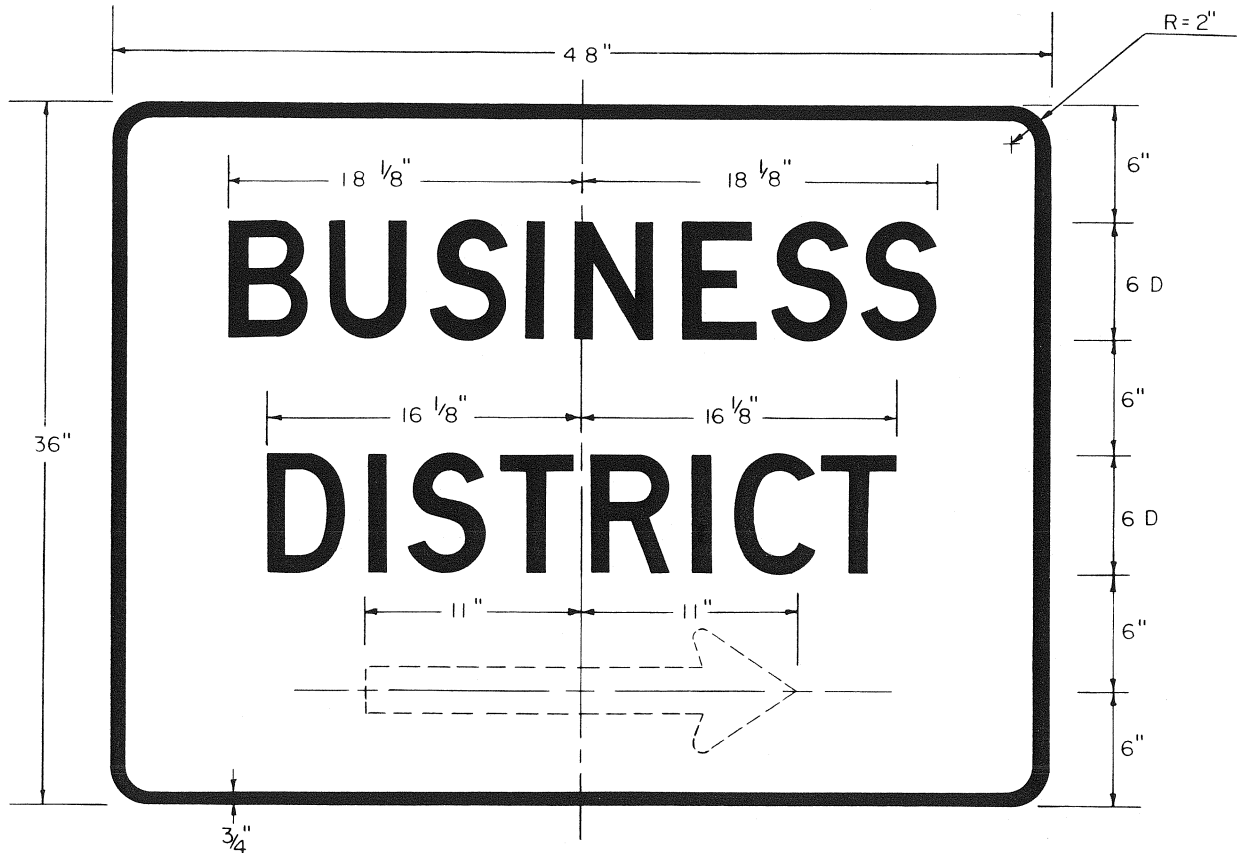

DI - 3K

LEGEND WHITE (REFL.)
 BACKGROUND GREEN (REFL.)

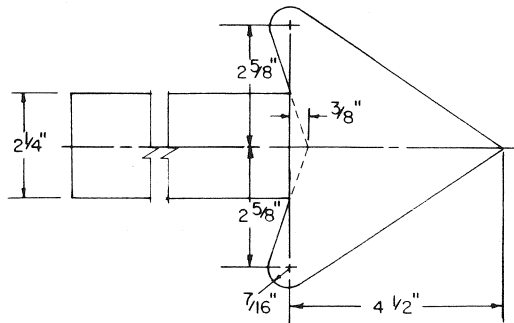



D 4-5

LEGEND
BACKGROUND

GREEN (REFL.)
WHITE (REFL.)

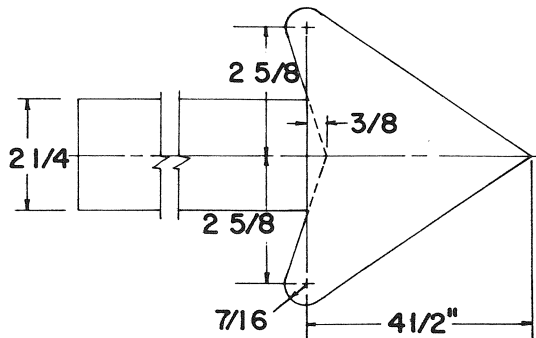

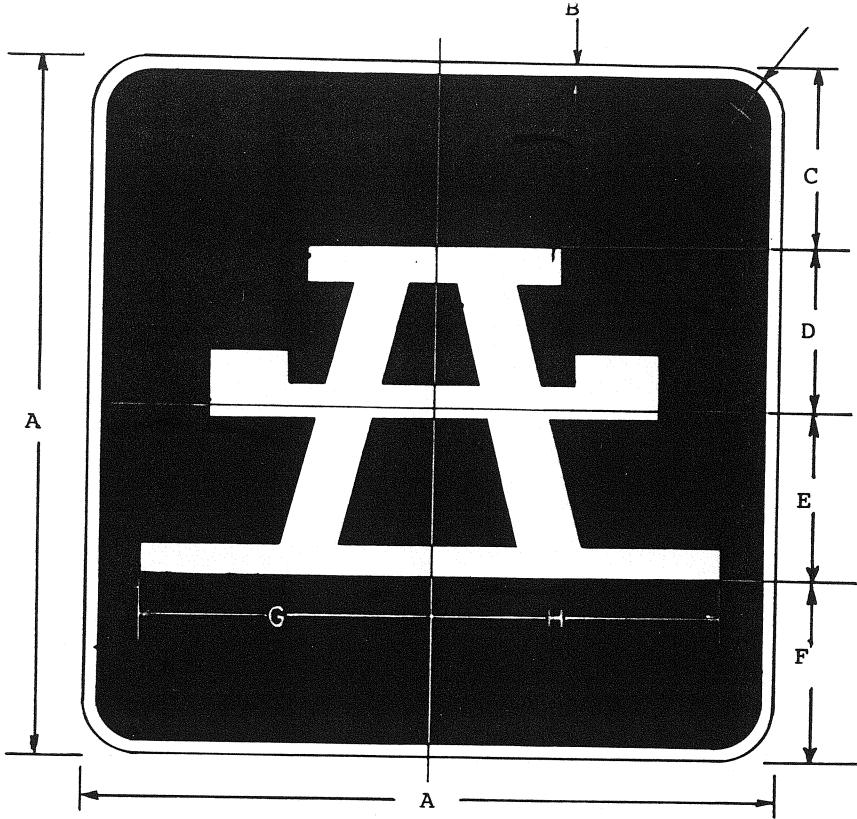

D5 - 5K

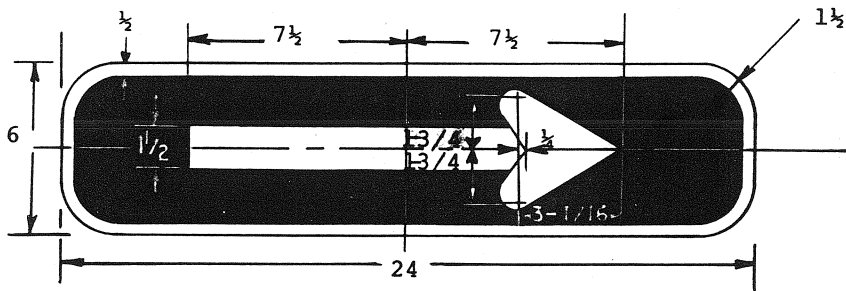

M6-7K

SIGN	DIMENSIONS (INCHES)								
	A	B	C	D	E	F	G	H	J
MIN	24	1/2	6 1/4	5 3/4	6	6	10	10	1 1/2
SPE- CIAL	30	3/4	7 13/16	7 3/16	7 1/2	7 1/2	12 1/2	12 1/2	1 7/8

COLORS

LEGEND - WHITE (REFL.)
BACKGROUND - BLUE (REFL.)

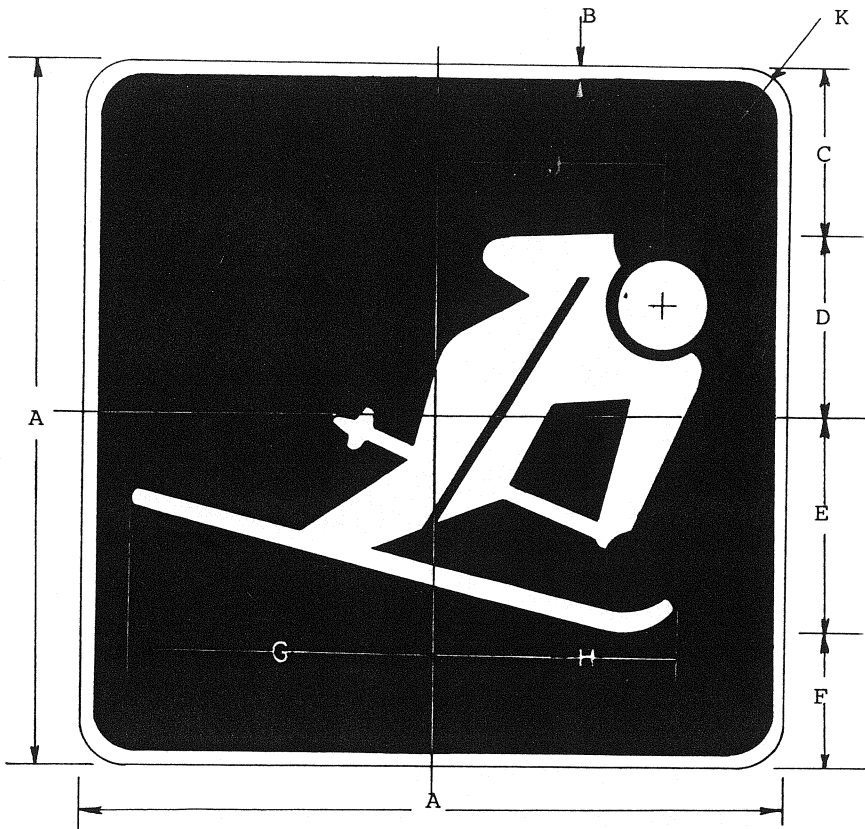

D9-50

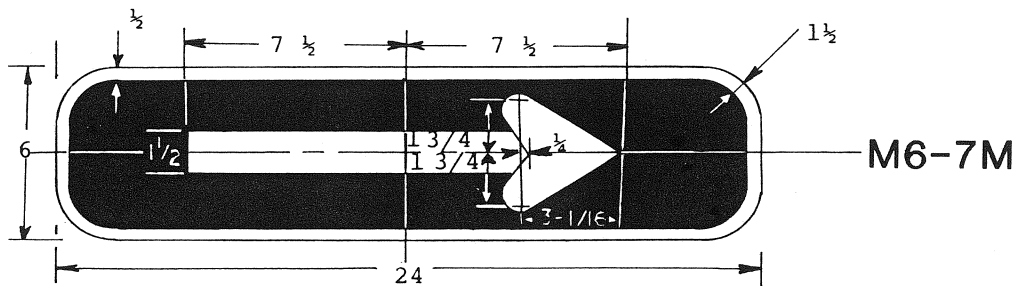
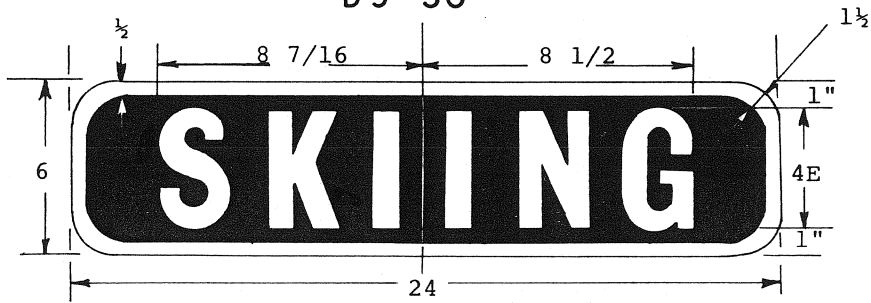

M6-7M

SIGN	DIMENSIONS (INCHES)									
	A	B	C	D	E	F	G	H	J	K
STD.	24	1/2	6 3/8	5 5/8	6 9/16	5 7/16	9 13/16	7 1/4	6 7/16	1 1/2
SPE-CIAL	30	5/8	7 31/32	7 1/32	8 7/32	6 25/32	12 1/4	9 1/16	8 1/32	1 7/8

COLORS
 LEGEND - WHITE (REFL.)
 BACKGROUND - BROWN (REFL.)

RW-080

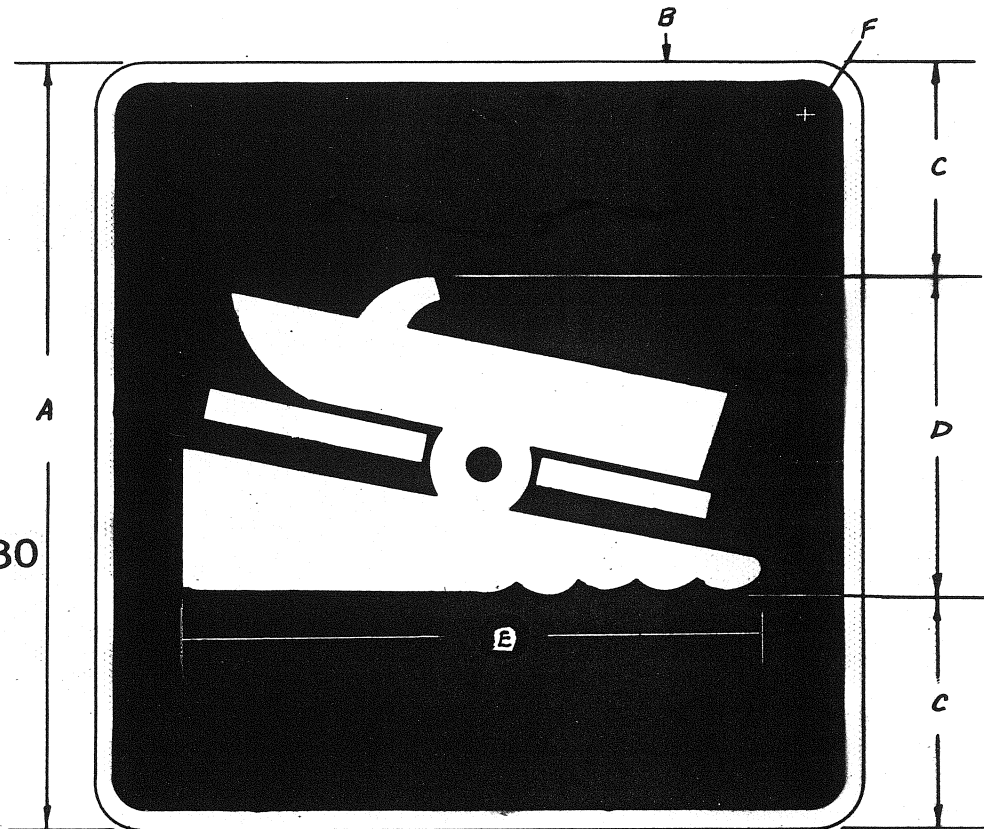

M6-7K

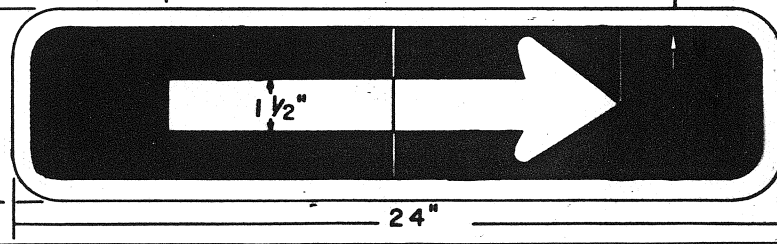

SIGN	DIMENSIONS (INCHES)								
	A	B	C	D	E	F			
STD. & MIN.	24	1/2	7	10	19 1/2	1 1/2			
SPECIAL	30	3/4	8 3/4	12 1/2	9 5/8	1 7/8			

LEGEND - WHITE (REFL.)
 BACKGROUND - BLUE (REFL.)
 3-16

CONSTRUCTION SIGNS



W5-2P

COLORS

LEGEND - BLACK (REFL)
BACKGROUND - ORANGE

SIGN	DIMENSIONS (INCHES)									
	A	B	C	D	E	F	G	H	J	K
MIN	36	30	$\frac{1}{2}$	$\frac{3}{4}$	$4\frac{3}{8}$	5 C	$3\frac{1}{8}$	$7\frac{3}{8}$	$1\frac{5}{8}$	$7\frac{5}{8}$
STD	42	36	$\frac{5}{8}$	$\frac{7}{8}$	$4\frac{1}{2}$	8 C	$3\frac{1}{2}$	$10\frac{1}{4}$	$2\frac{1}{4}$	$8\frac{9}{10}$



SIGN	DIMENSIONS (INCHES)												
	A	B	C	D	E	F	G	H	J	K	L	M	N
MIN	36	7/8	5/8	5C	2 1/2	2 1/2	10 5/64	10	12 29/64	12 27/64	11 27/64	11 23/64	2 1/4
STD	48	1 1/4	3/4	6C	3 1/2	3 1/2	12	11 15/16	15 3/8	15 5/16	14	13 7/8	3

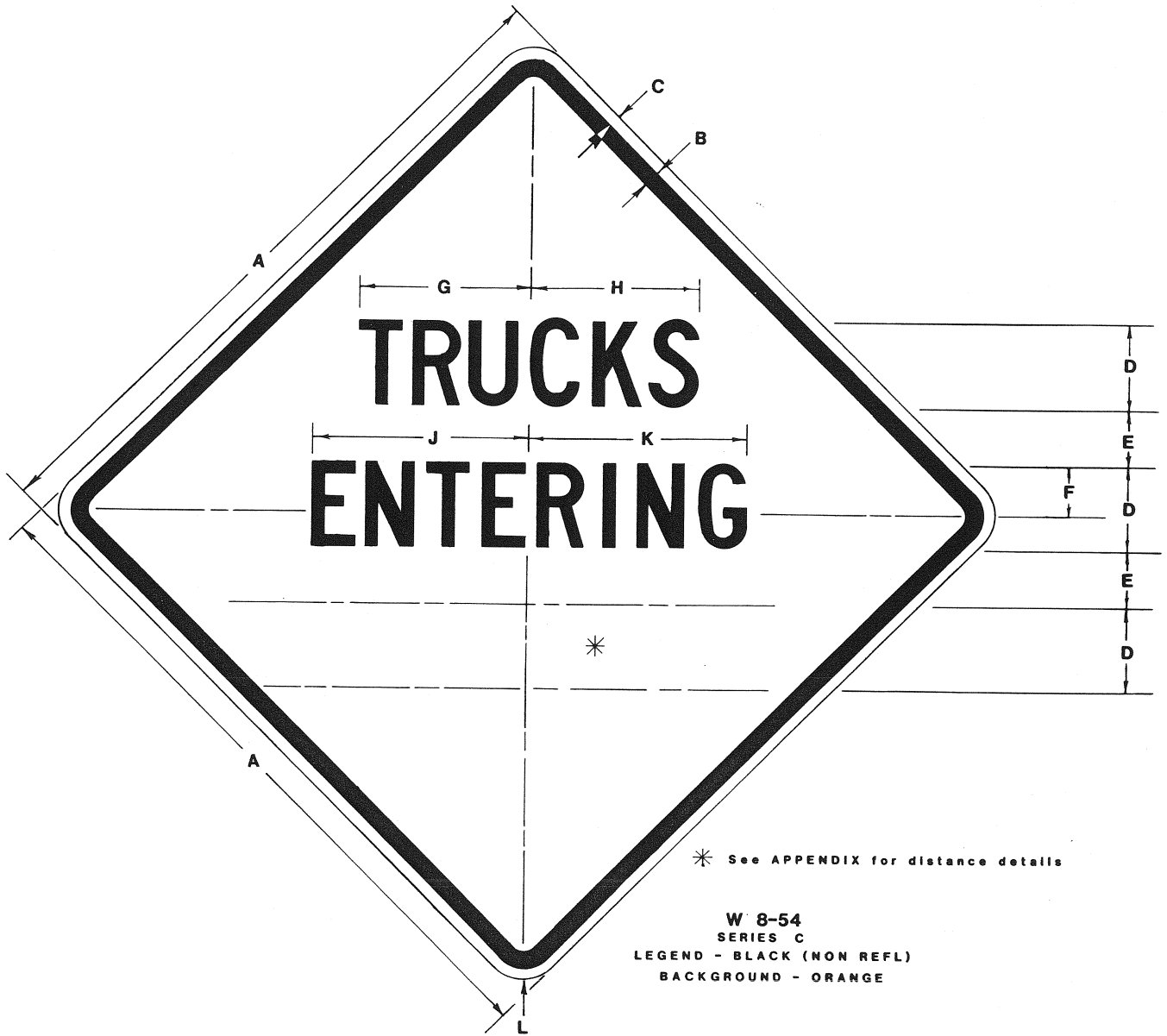

SIGN	DIMENSIONS (INCHES)										
	A	B	C	D	E	F	G	H	J	K	L
MIN	36	7/8	5/8	5C	2 1/2	2 1/2	10 5/64	10	12 29/64	12 27/64	2 1/4
STD	48	1 1/4	3/4	6C	3 1/2	3 1/2	12	11 15/16	15 3/8	15 5/16	3

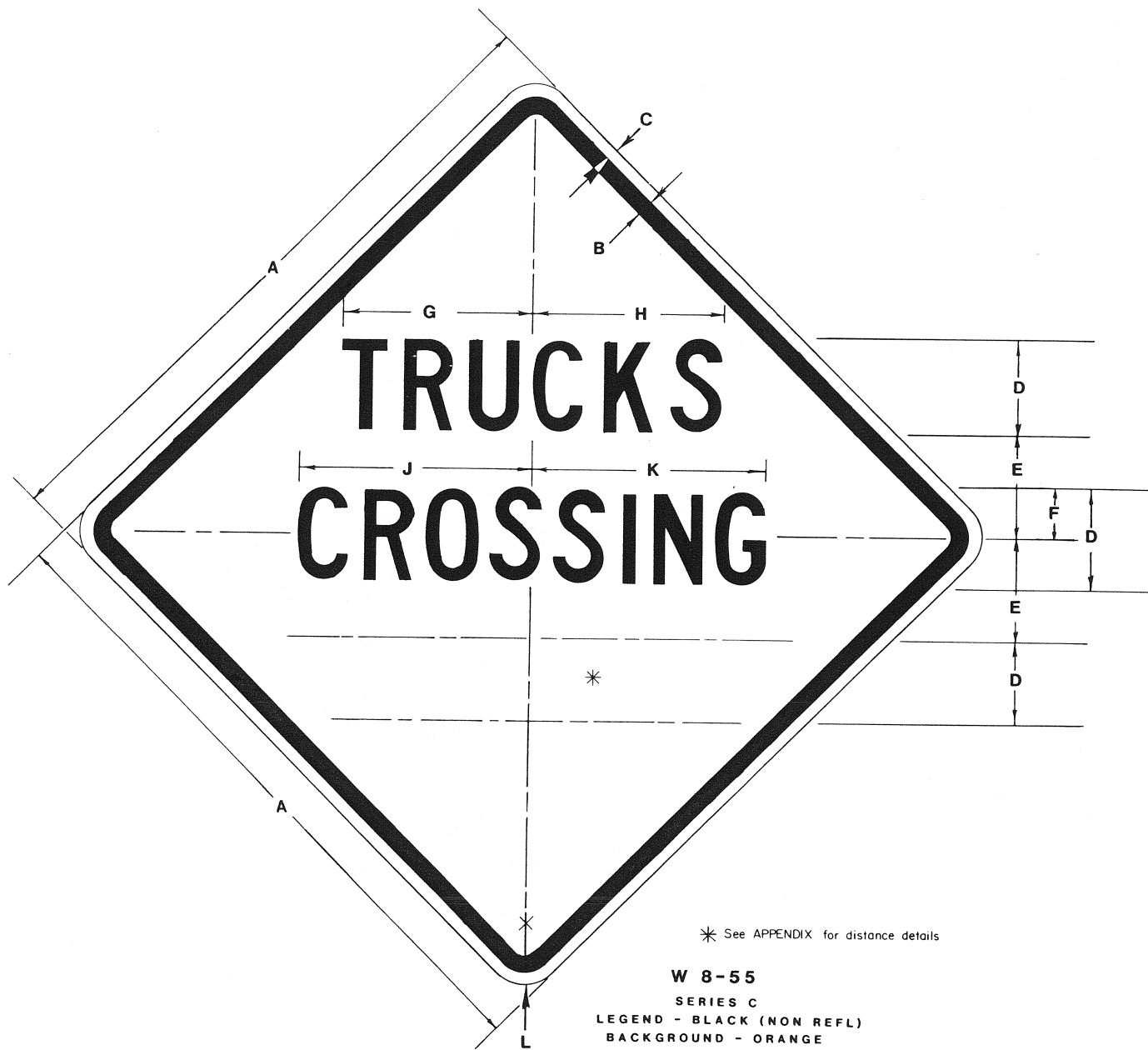

SIGN	DIMENSIONS (INCHES)										
	A	B	C	D	E	F	G	H	J	K	L
MIN	36	7/8	5/8	5C	2 1/2	2 1/2	10 5/8	10	12 29/32	12 29/32	2 1/4
STD	48	1 1/4	3/4	7C	4	3 1/2	13 15/16	14	17	17	3

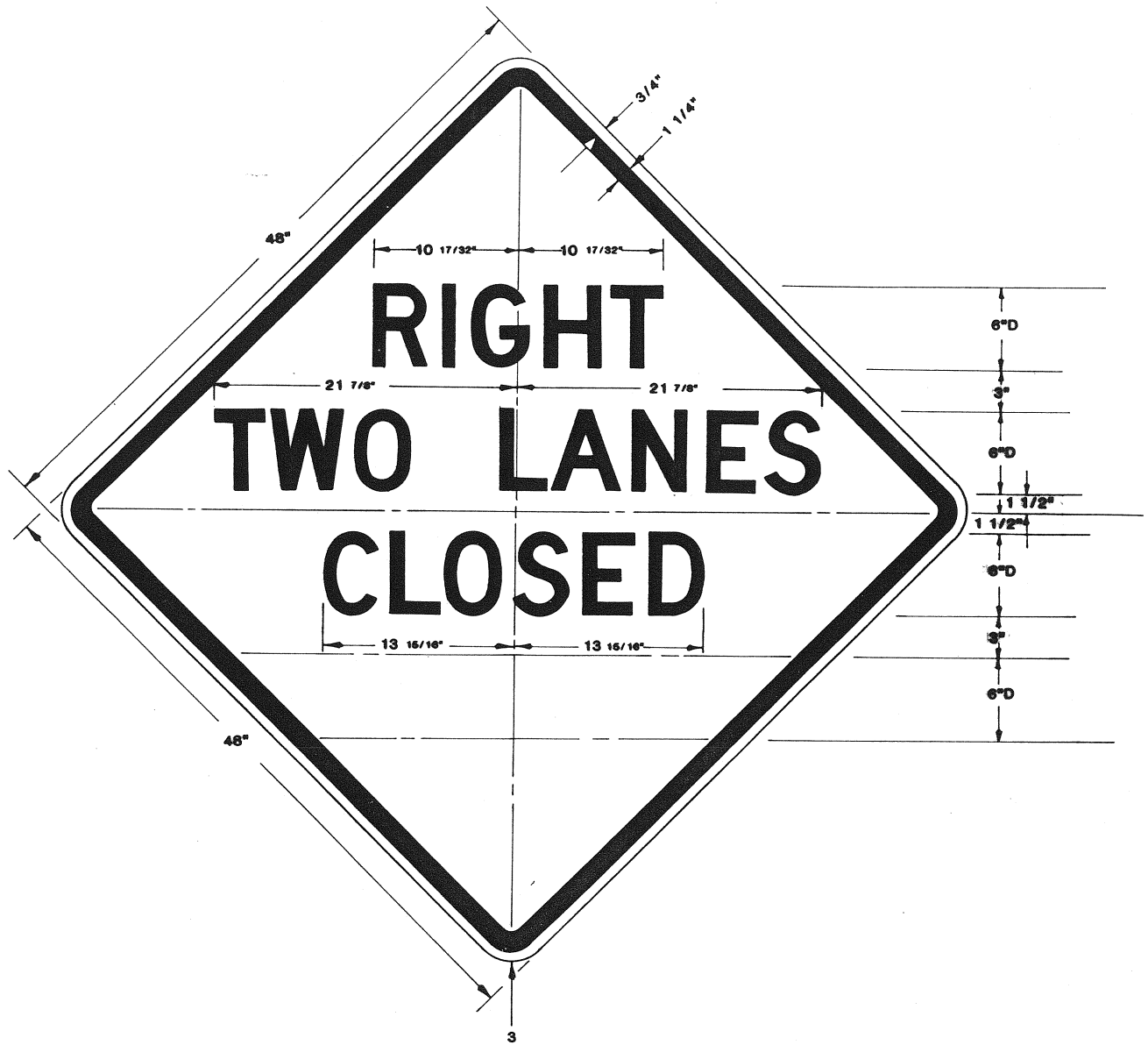

W20-9

COLORS

LEGEND - BLACK

BACKGROUND - ORANGE

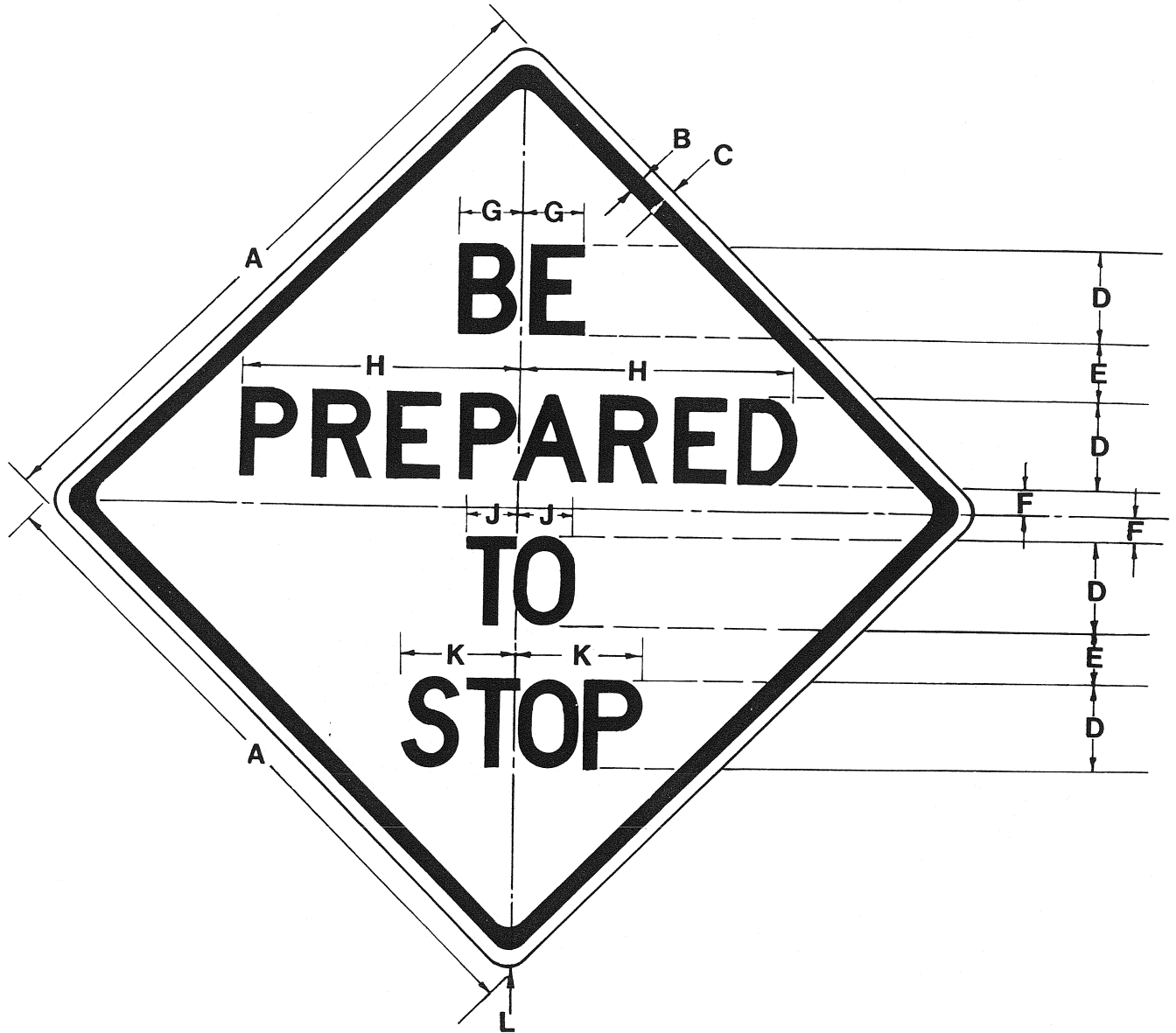

W 20-50

COLORS
 BACKGROUND-ORANGE
 LEGEND-BLACK(NON-REFL)

SIGN	DIMENSIONS (INCHES)										
	A	B	C	D	E	F	G	H	J	K	L
MIN	30	3/4	1/2	4C	2	1	2 5/8	10 3/4	2 5/16	5 1/8	1 13/16
STD	36	7/8	5/8	5C	2 1/2	1 1/4	3 1/4	13 1/2	2 7/8	6 3/8	2 1/4
SPECIAL	48	1 1/4	3/4	7C	3	1 1/2	4 9/16	18 7/8	4	8 15/16	3



W20-51

SIGN	DIMENSIONS (INCHES)								
	A	B	C	D	E	F	G	H	J
MIN	30	3/4	1/2	4C	2	1 1/2	9 1/4	12 1/8	1 13/16
STD	36	7/8	5/8	5C	3	1 7/8	11 3/4	15 5/32	2 1/4
SPECIAL	48	1 1/4	3/4	7C	4	2 1/2	17	21 1/4	3

COLORS

LEGEND - BLACK (NON REFL)
BACKGROUND - ORANGE

4-7

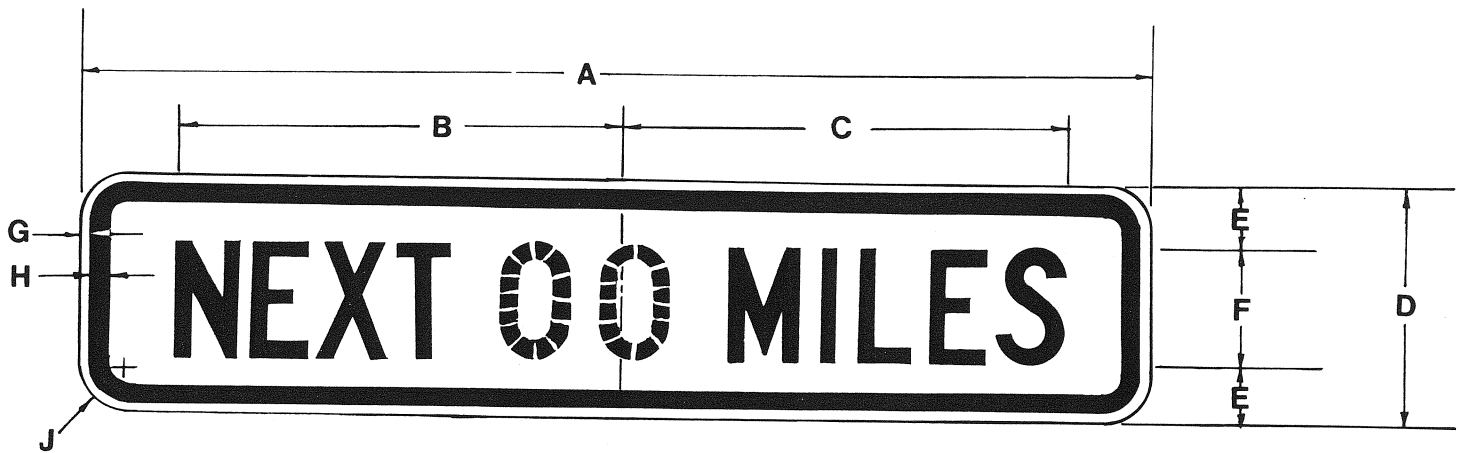

W20-52

COLORS

LEGEND - BLACK (NON REFL)

BACKGROUND - ORANGE

SIGN	DIMENSIONS INCHES								
	A	B	C	D	E	F	G	H	J
MIN	36	15 9/32	15 9/32	12	4	4C	1/2	3/4	1 5/8
STD	54	22 13/64	22 13/64	12	3	6C	1/2	3/4	1 5/8



W21-50

SIGN	DIMENSION (INCHES)									
	A	B	C	D	E	F	G	H	J	K
MIN	36	5/8	1	5	5	11 3/64	11 1/32	13 15/16	13 7/16	2 1/2
STD	48	3/4	1 1/4	6	6	13 5/16	13 3/8	17	16 15/16	3

LEGEND - BLACK (NON REFL)
BACKGROUND ORANGE



SIGN	DIMENSION									
	A	B	C	D	E	F	G	H	J	K
MIN	30	1/2	7/8	2	4C	1 3/4	2	10	2 37/64	9 3/8
STD	36	5/8	1	2 1/2	5C	2 1/2	2 1/2	12 1/2	3 7/32	11 23/32
SPECIAL	48	3/4	1 1/4	3	6C	3	3	15	3 7/8	14 1/16

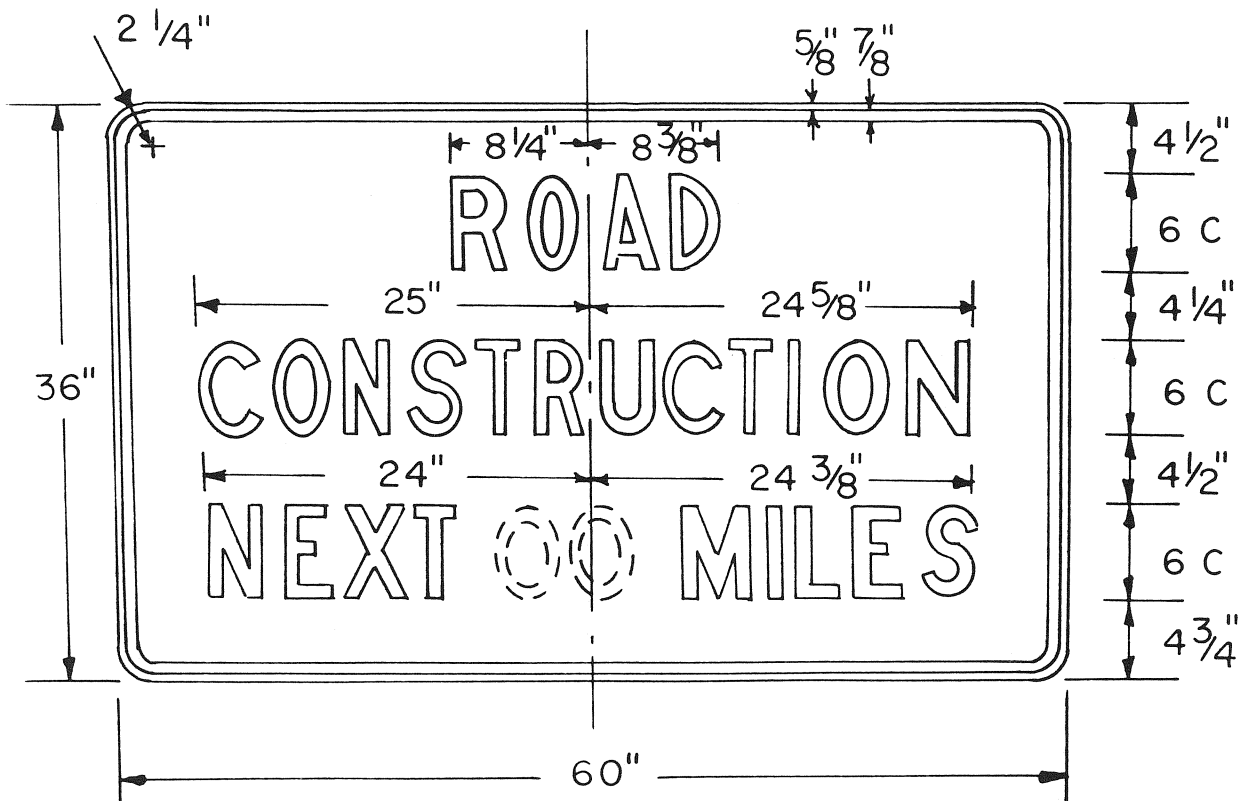

G20-1-60

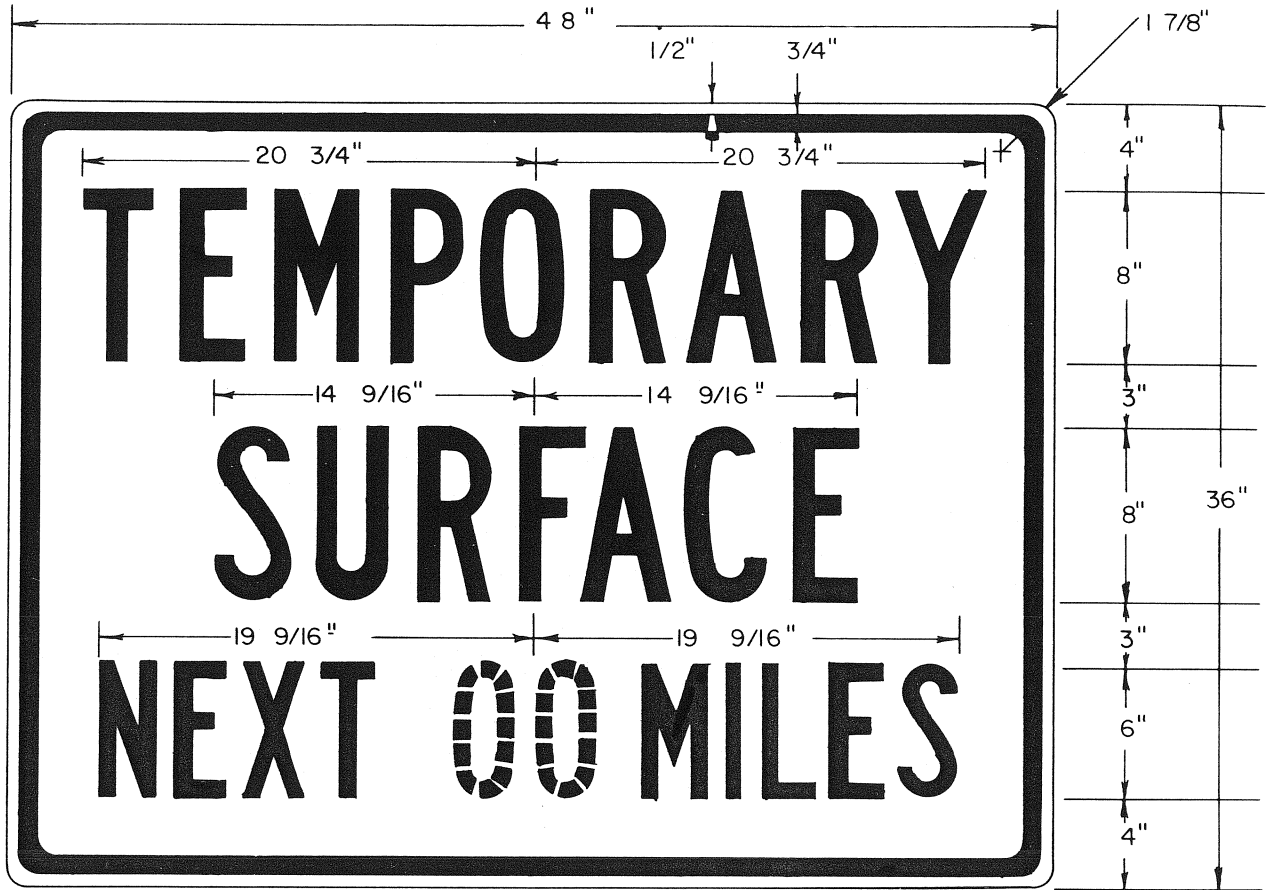

G 20-8-48
 COLORS
 LEGEND - BLACK (NON REFL)
 BACKGROUND-ORANGE
 SERIES B
 187 d

G20-8-48

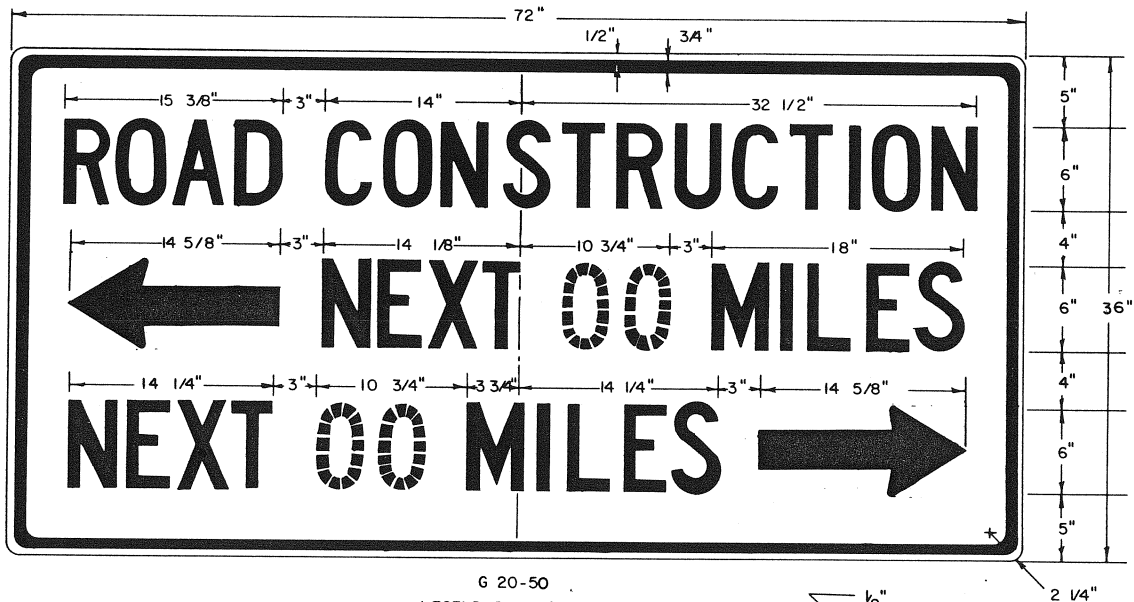

G 20-50
 LEGEND - BLACK (NONREFL)
 BACKGROUND - ORANGE
 SERIES - C

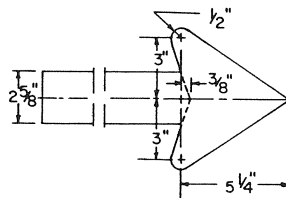

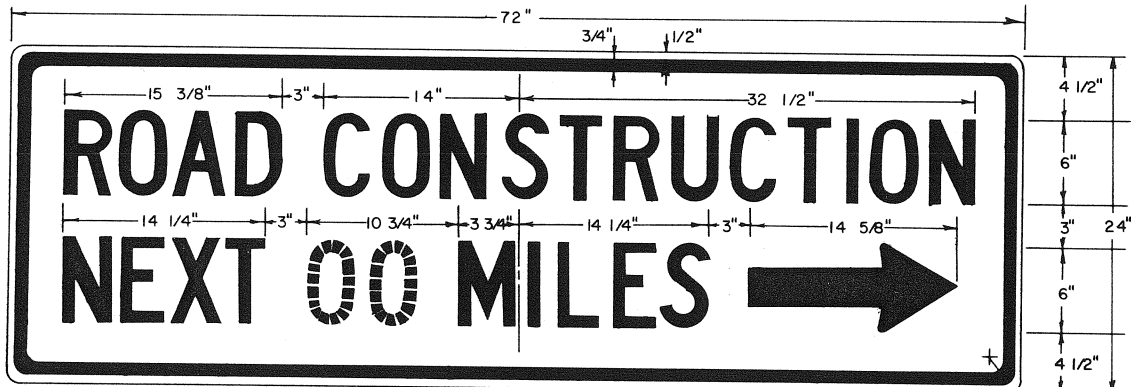

G 20-52
 COLORS
 LEGEND - BLACK (NON REFL)
 BACKGROUND - ORANGE
 SERIES - C

Arrow may be to right or left of legend to indicate construction to the right or left.

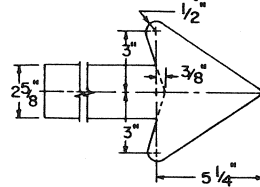

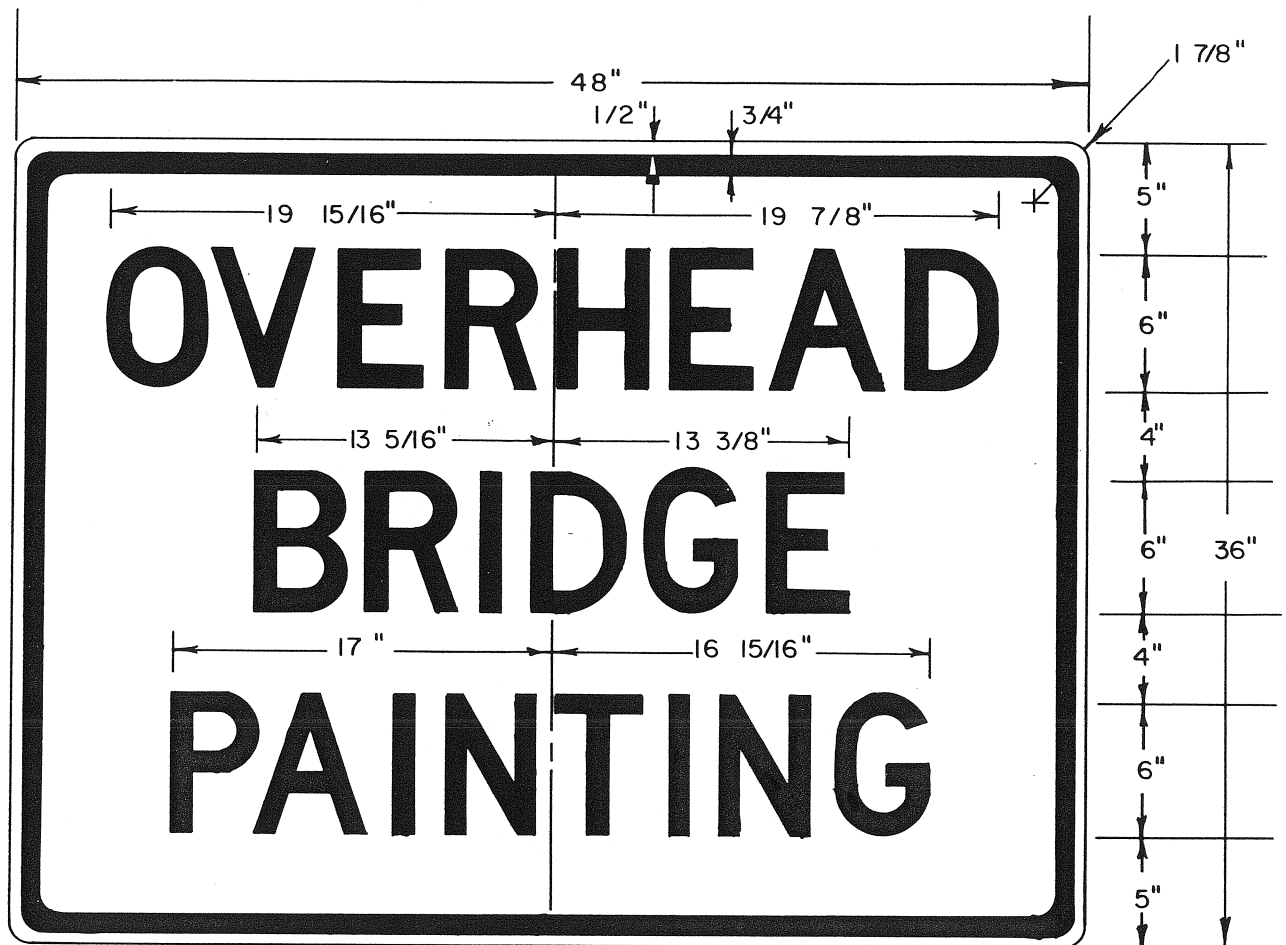

G20 - 54
 COLORS
 LEGEND - BLACK (NONREFL)
 BACKGROUND - WHITE (REFL)
 SERIES D ORANGE

